



CONTENTS

NEW ARRIVAL	4
CAR & OUTDOOR	60
FURNITURE	94
HOUSEWARE	154
GARDEN & GREEN	244
KITCHENWARE	270
SMALL SUNDRIES	332
INDEX	358

The DULPEDIA 2024

2024 Dulton Co., Ltd.
www.dulton.jp

Printed in Japan

Issued by: Dulton Co., Ltd.
Copyright © 1988 by Dulton Co., Ltd.
Photographed at the Dulton Shizuoka Studio
& Dulton 2nd Studio

Special thanks: Dulton home builders kitakyushu
Photographer: Bono, Ryo Matsubayashi, Kawauchi
Decoration: Kozue, Rika, Hiroshi, Kosho, SG, Honda,
Nambu, Yukiya, Hiroto, Ayumu, Ruri
Catalog Design: Keisuke Kawauchi, Juri Nishiwaki, Yuma
Assistant: Washi
Editor in chief: Keisuke Kawauchi
Dulton Co., Ltd.

All rights reserved

カタログの見方

Light-45 stool			商品名
Model 113-300			品番 (発注番号)
H.450 W.375 D.375mm			サイズ・重量等
seat 290×290mm			
Color	Seat color	Price	バーコード
● H.D Galvanized	Black	¥12,800+税	
● Raw	Black	¥11,400+税	
● Ivory	Brown	¥10,000+税	
● Red	Black		
● Brown	Brown		
● Hammertone gray	Black		

本体価格+税表示
本カタログは価格表示を「本体価格+税」と表記しております。

カラー
各仕様のマーク (ピクトグラム)
マークの内容は下記「各仕様のマーク (ピクトグラム)」についてをご参照ください。

[LOT] 表示について

商品の発注につきましては基本的には1個からの発注にご対応させて頂いておりますが、一部の商品につきまして、発注単位がございます。
LOTで記載された数量は発注単位です。この数量の倍数にて、ご注文願います。発注単位につきましては予告なく変更する場合がございます。ご了承ください。

各仕様のマーク (ピクトグラム)について

	組立が必要な商品には左図のマークで表示しております。		別途送料が必要となる商品には、左図のマークを表示しております。詳しくは担当者までお問い合わせください。
	納入価格につきましては各営業担当までお問い合わせください。		同サイズ、もしくは同種でスタッキングが可能な商品は、左図のマークを表示しております。
	納入価格につきましては各営業担当までお問い合わせください。		左記のマークのついている商品は、器具を取り付ける天井に下図のいずれかのアダプターが設置されていれば簡単に取り付けることができます。
	本カタログより商品の価格に値上げ変更がある場合、左図のマークを表示しております。		下図のアダプターが天井の強度のある面に確実に取り付けられていることをお確かめの上、器具を取り付けてください。天井やアダプターの形状により一部工事が必要となる場合がございます。
	本カタログより商品の価格に値下げ変更がある場合、左図のマークを表示しております。		
	本カタログより製品番号が変更となっている製品には左図のマークを表示しております。		

商品に関する注意事項

- **スツール・キャビネット等、脚部やキャストに樹脂(ゴム・プラスチック含む)を使用している商品について**
床の素材により、接地面に色移りしたり、キズが付いてしまう場合がございます。ご使用の際は、布やカーペットを敷いてのご使用をお勧めします。
- **シーリングファンの設置について**
シーリングファンの設置は必ず電気配線専門業者にご依頼ください。設置後も、電球交換・羽の回転方向切り替えが容易にできる高さ(脚立等を使用して届く高さ)に設置してください。
- **キャンドル及びキャンドルホルダーについて**
点灯中は、絶対にその場を離れないでください。離れる際は必ず「消火」をご確認ください。カタログ内に記載されている「燃焼時間」はあくまでも目安の時間です。ご使用する環境等で若干のスレが生じる場合がございます。カバー清掃時、タワシや塵粉は使用しないでください。表面に細かな傷が付き、破損の原因となります。キャンドルとガラスの距離が近いと熱がガラスの一点に集中し破損する恐れがあります。
- **セラミック・ポーセリン等の陶磁器製品について**
素地や釉薬の特性上、形状・質感に多少のばらつき、表面に小さな黒点や釉薬上のへこみ(ピンホール)が生じることがございます。製品の特性としてご理解ください。
- **アンティークの風合いを出した製品について**
一部製品にアンティークの風合いを出すための仕上げ(キズや塗装はがれ・色ムラ・印刷のかすれ等)が施されております。多少の個体差があります。製品の特性としてご理解ください。
- **カラーポット、カラーベース製品について**
ハンドメイドのため、形やサイズ、焼き色等に個体差が生じます。表面のキズ、ピンホールや素地部分、底穴周りにヒビが生じている場合がございます。釉薬の掛かり方によって色ムラがあったり、焼いている最中にできた細かなヒビ(貫入)や歪みが見られる場合がございますがご使用上問題ございません。製品の特性としてご理解ください。
- **マルチクロス・マルチカバー等、インド綿を使用した製品について**
ハンドメイドのため、染色の際に生地が縮み、表記サイズと若干異なる場合がございます。色ムラ・糸のほつれ・糸とび等がございますが製品の特性としてご理解ください。インド綿特有のニオイが気になる場合は風通しの良い場所で陰干しすることにより解消されていきます。洗濯の際は他の物と分けて洗ってください。
- **RAW仕上げの製品について**
クロムメッキやカラータイプとは異なり、金属の質感を見せるため、素地にクリア仕上げを施しております。溶接痕や研磨跡、一部サビや擦れが見られる場合もございます。素地の色味や仕上がりの風合いに個体差が見受けられます。RAW仕上げの特性としてご理解ください。



- **レザー製品について**
天然素材に染色や加工を施して生産されております。製造時期によっては色味や風合いに個体差が生じる場合がございます。製品の特性としてご理解ください。
- **天然木材製品について**
天然の素材を使用しておりますので、木目や色に個性が生じます。また採取地や時期によっても個体差が生じます。製品の特性としてご理解ください。

カラーサンプル

印刷の都合上、写真と実物の色が多少異なる場合がございます。カラーズワッチ (色見本)につきまちは各営業担当までお問い合わせください。



Color swatch
Model 100CLR
*Steel

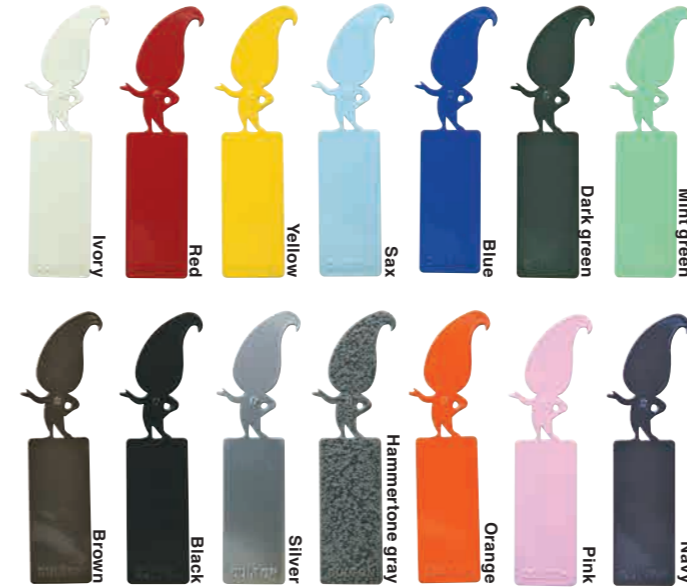

Color swatch
Model 100CLRP
*Polyethylene

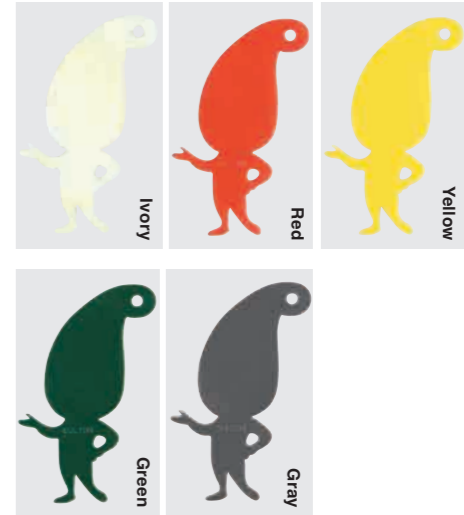

INFORMATION

- 掲載商品の仕様、価格、カラー等は予告無く変更する場合がございます。ご了承ください。
- 掲載商品は予告無く販売終了や生産中止となる場合がございます。
- 掲載商品の価格には搬入・組立・梱包・送料等の費用は含まれておりません。
- 印刷の都合上、写真と実物の色が多少異なる場合がございます。
- サイズ、重量などは多少の個体差がございます。ご了承ください。
- 本カタログから写真を転載・引用される場合は弊社営業担当者までご連絡ください。
- カタログ発行、2024年2月。



The DULPEDIA 2024

NEW ARRIVAL



Aluminum clip lamp

定格電圧：100V
 使用電球：LED電球 MAX 25W/E26
 材質：アルミニウム(カラーのみ粉体塗装)
 スチール(亜鉛メッキ)、PVC



◎電球は付属しません。
 ◎シェードは取り外し可能です。
 ◎LED電球専用です。
 ◎製造工程上、仕上がりに個体差があります。

S
 L.350 φ140mm
 Cord 1800mm
 Weight 0.39kg
 ¥4,900+税

M
 L.370 φ218mm
 Cord 1800mm
 Weight 0.43kg
 ¥5,400+税



Aluminum / S
 Model DS-0630S/AL
 4 997337 090681

Aluminum / M
 Model DS-0630M/AL
 4 997337 090735



Ivory / S
 Model DS-0630S/IV
 4 997337 090698

Ivory / M
 Model DS-0630M/IV
 4 997337 090742

Red / S
 Model DS-0630S/RD
 4 997337 090711

Red / M
 Model DS-0630M/RD
 4 997337 090773



Yellow / S
 Model DS-0630S/YL
 4 997337 090728

Yellow / M
 Model DS-0630M/YL
 4 997337 090780

Olive drab / S
 Model DS-0630S/OV
 4 997337 090704

Olive drab / M
 Model DS-0630M/OV
 4 997337 090766



Aluminum pendant lamp with glass cover

Model 100-093OV
 H.170 φ162mm
 Cord 1100mm
 Weight 0.5kg
 ¥5,400+税
 材質：アルミニウム（粉体塗装）、ガラス
 定格電圧：100V
 使用電球：白熱電球 MAX 40W/E26
 LED電球 MAX 4W/E26

◎電球は付属しません。



Color	Barcode
Aluminum	4 997337 009300
Ivory	4 997337 009317
Red	4 997337 009324
Olive drab	4 997337 090520

NEW



Single spin canvas blades gray

Model DT18-CF08GY
 Weight 10kg
 ¥63,000+税
 定格電圧：100V
 4 997337 092791

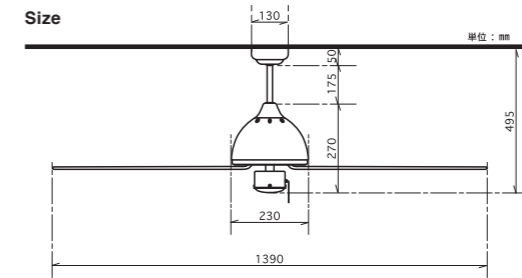

- ◎ライティングキット・コントローラーキットは別売りです。
- ◎速度調節スイッチは本体に付いています。(チェーン部分)
- ◎プラグと電気コードは付属しません。

SPEED	RPM		Watt		Amp	
	50Hz	60Hz	50Hz	60Hz	50Hz	60Hz
HIGH	87	75	34	41	0.36	0.42
MIDIUM	62	63	24	27	0.3	0.36
LOW	34	31	7	9	0.17	0.18

【取り付け箇所に関する注意】天井取り付け専用です。壁面には取り付けできません。

- ◎調光器が取り付けられている回路でご使用になりますとファンやランプの寿命を縮めたり、異常回転による振動が発生したりする原因となります。
- ◎障害物がある場所への設置はリモコンの誤作動等の原因となります。
- ◎電球交換・羽の回転方向切替えが容易にできる高さ(脚立を使用して届く高さ)に設置してください。
- ◎傾斜天井への設置はできません。
- ◎取り付けは必ず電気工事業者へご依頼ください。



オプションパーツ Model E20-0279 Lighting kit 装着イメージ

Spare blades set of 4 Gray

Option for DT18-CF08
 Model DT18-CF/B/GY
 540×260mm / each
 ¥4,800+税
 材質：本体/コットン
 バイビング/ポリエステル
 4 997337 092623



Off white

⇒この製品の他のカラーやオプションパーツはP123に掲載されています。



Double face clock 170D2

H.205 W.285 D.90mm
Weight 1.5kg
¥11,000+税



⇒このシリーズのその他の製品は
P203に掲載されています。

材質：本体 / スチール(粉体塗装)
文字盤フレーム / スチール(クリアラッカー仕上げ)
カバー / ポリスチレン

使用電池 単3×2pcs
Sweep movement



Mat Black / Raw
Model YR-0643MBK
4 997337 091220



Mat Ivory / Raw
Model YR-0643MIV
4 997337 091251



Mat Brick / Raw
Model YR-0643MBC
4 997337 091268

◎RAWの文字盤フレームは金属素地にクリアラッカー仕上げを施しております。
溶接痕や研磨跡、一部サビや擦れが見られる場合もございます。
素地の色味や仕上がりの風合いに個体差があります。
RAW仕上げの特性としてご理解ください。

Steel frame mirror with pegboard

Model GM-0660
H.1800 W.1300 D.270mm

¥60,000+税

材質：スチール、ガラス、MDF、メラミン化粧板

4 997337 092647



ロゴプレート



©P128掲載の Model D19-0040/1890 Galvanized fence 1800×900を D19-0041 Galvanized parts 32×32を使用して連結することも可能です。

◎製造工程上、パイプ部やフレーム部の表面にスレや汚れのような跡がみられます。製品の特性としてご理解ください。





Open-closed sign stand

Model 123-385
H.1100 W.569 D.290mm
¥16,800+税

材質：スチール(クロムメッキ)、アルミニウム

4 997337 092951



- 看板部分を回転させる事でOPEN⇄CLOSEDが切り替わります。
- 強風時は転倒等の恐れがありますのでご使用をお控えいただくか、「重し」等ですっかりと固定してご使用ください。
- 雨天時の屋外でのご使用はお止めください。





DULTON Tray stand

High) H.840 φ220mm

Low) H.540 φ220mm

¥11,000+税

材質：スチール(粉体塗装)、セメント



⇒このシリーズのその他の製品は P151に掲載されています。



Silver
Model RNZ-0624SV
4 997337 090469

Low pole

High pole



Raw
Model RNZ-0624RW
4 997337 090476

Low pole

High pole

◎2サイズのボールが付属しております。用途に合わせて付け替えてご使用ください。
◎安全のため、トレイに載せるものは1kg以下にしてください。

Galvanized garden edge fence

材質：スチール(溶融亜鉛メッキ)



S
Model NB-0641S
H.520 W.600 D.32mm
¥6,800+税 4 997337 091169

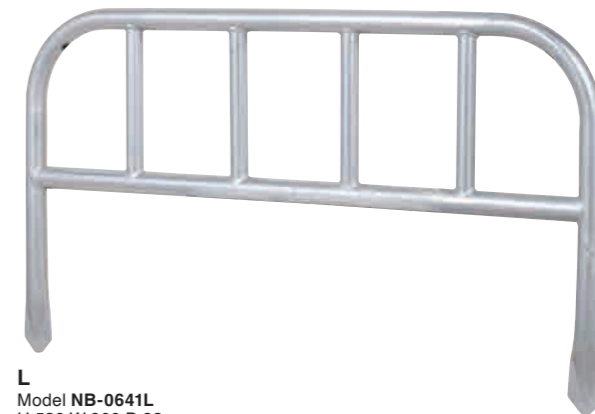

L
Model NB-0641L
H.520 W.900 D.32mm
¥9,000+税 4 997337 091183

Galvanized blockade

材質：スチール(溶融亜鉛メッキ)

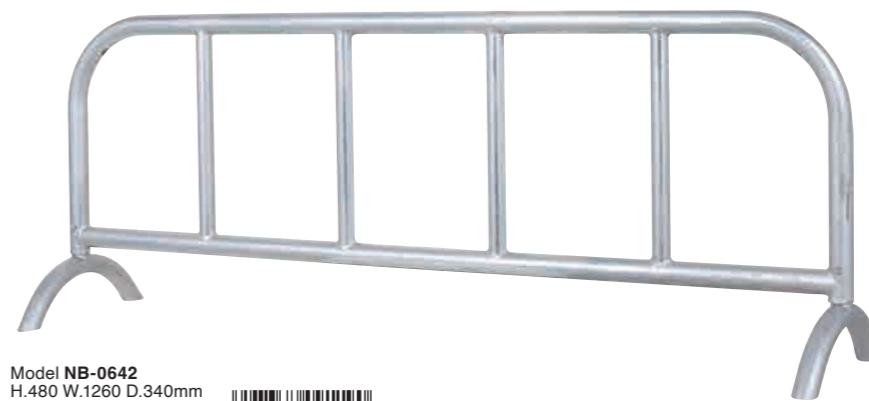

Model NB-0642
H.480 W.1260 D.340mm
¥12,000+税 4 997337 091190

◎製造工程上、パイプ部やフレーム部の表面にスレや汚れのような跡がみられます。製品の特性としてご理解ください。





Cooler bag

材質：本体 / ターポリン、ポリウレタン、ポリプロピレン
 インナーバッグ / PEVA



S
 Model V23-0657S
 H.250 W.380 D.270mm
 20L
 ¥7,700+税



L
 Model V23-0657L
 H.330 W.470 D.250mm
 40L
 ¥8,800+税



◎付属品 ストラップ



インナーバッグ



◎インナーバッグは取り外せます。

Folding mesh storage

材質：ポリプロピレン



11L

Model V21-0346
H.140 W.400 D.300mm
Inside H.120 W.360 D.265mm
Folding H.53 W.400 D.300mm
¥2,000+税

⇒この製品のその他のシリーズはP67に掲載されています。

◎付属品 カード1枚



Card 11L

85×54mm 材質：PP



Black×Silver
Model V21-0346BK/SV 4 997337 092821



Green×Yellow
Model V21-0346GN/YL 4 997337 092845



Coyote×Blue
Model V21-0346CO/BL 4 997337 092838



Folding



Stacking

48L

Model V21-0347
H.260 W.600 D.400mm
Inside H.245 W.560 D.360mm
Folding H.53 W.600 D.400mm
¥4,500+税

◎付属品 カード1枚

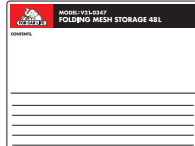

Card 48L

150×100mm 材質：PP

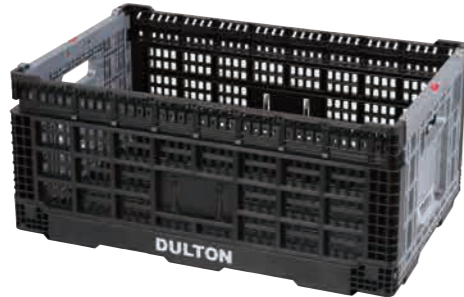

Black×Silver
Model V21-0347BK/SV 4 997337 092852



Green×Yellow
Model V21-0347GN/YL 4 997337 092876



Coyote×Blue
Model V21-0347CO/BL 4 997337 092869



Folding



Stacking

Folding shopping basket 30L

材質：ポリプロピレン



Model V22-0505
H.310 W.480 D.210mm
Folding H.95 W.480 D.210mm
¥3,400+税

⇒この製品のその他のシリーズはP66に掲載されています。

◎付属品 カード1枚



Card

85×54mm 材質：PP



Black×Silver
Model V22-0505BK/SV 4 997337 092883



Green×Yellow
Model V22-0505GN/YL 4 997337 085588



Coyote×Blue
Model V22-0505CO/BL 4 997337 092890



Folding



Stacking



FOR CAR LIFE
DULTON CO., LTD.



Mesh pouch

材質：ポリエステル、ジंकアロイ

S
H.170 W.240mm
¥270+税



Royal blue / S
Model RN-0637S/BL 4 997337090957



Gray / S
Model RN-0637S/GY 4 997337090896

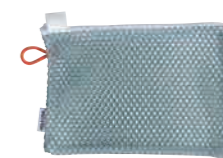

Gray green / S
Model RN-0637S/GG 4 997337090926

M
H.240 W.340mm
¥350+税



Royal blue / M
Model RN-0637M/BL 4 997337090940



Gray / M
Model RN-0637M/GY 4 997337090889



Gray green / M
Model RN-0637M/GG 4 997337090919

L
H.300 W.400mm
¥430+税



Royal blue / L
Model RN-0637L/BL 4 997337090933



Gray / L
Model RN-0637L/GY 4 997337090872



Gray green / L
Model RN-0637L/GG 4 997337090902

Laundry wash bag

材質：ポリエステル、ジंकアロイ

S
H.300 W.420mm
¥400+税



Royal blue / S
Model RN-0638S/BL 4 997337091084

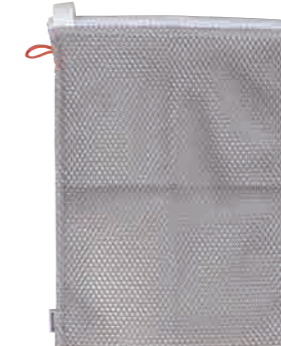

Gray / S
Model RN-0638S/GY 4 997337090971

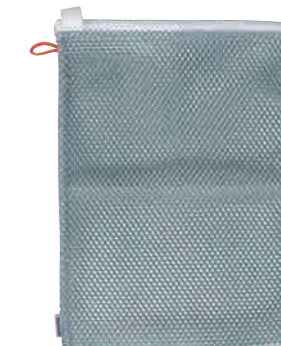

Gray green / S
Model RN-0638S/GG 4 997337090995

L
H.420 W.600mm
¥700+税



Royal blue / L
Model RN-0638L/BL 4 997337091077



Gray / L
Model RN-0638L/GY 4 997337090964



Gray green / L
Model RN-0638L/GG 4 997337090988

Laundry wash bag

材質：ポリエステル、ポリプロピレン、ポリアセタール

⇒この製品のその他のシリーズはP184に掲載されています。



Gusset / S

Model RN-0639S/WT
H.170 W.250 D.80mm
¥490+税

4 997337 091152



Gusset / L

Model RN-0639L/WT
H.200 W.350 D.90mm
¥590+税

4 997337 091145



Oval / S

Model RN-0640S/WT
H.200 W.285 D.200mm
¥440+税

4 997337 091138



Oval / L

Model RN-0640L/WT
H.250 W.385 D.250mm
¥540+税

4 997337 091091

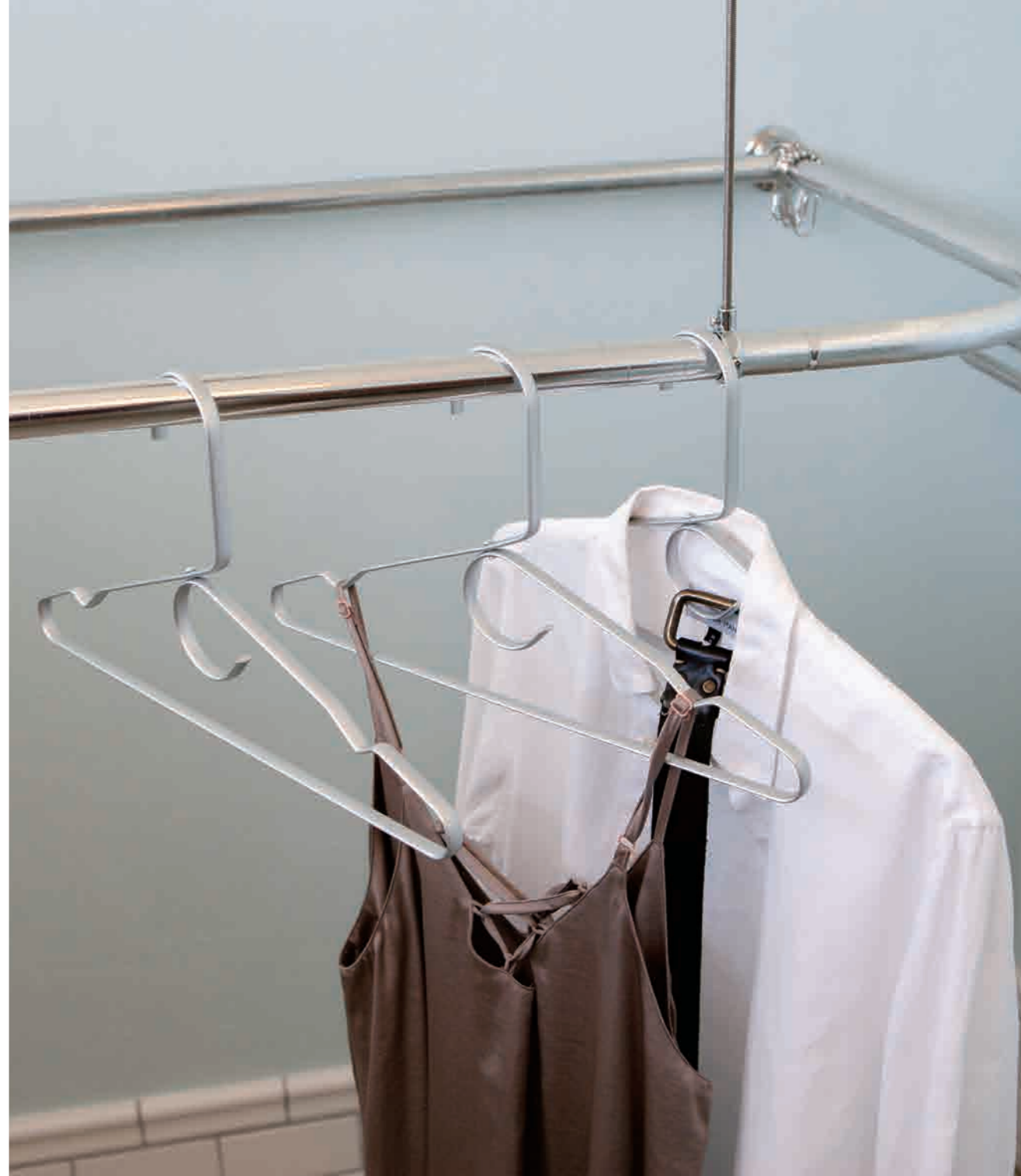

S/3 Aluminum hanger

Model RNR-0644S/3
H.218 W.412 D.10mm
3pcs / set
¥1,500+税

材質：アルミニウム

4 997337 091282

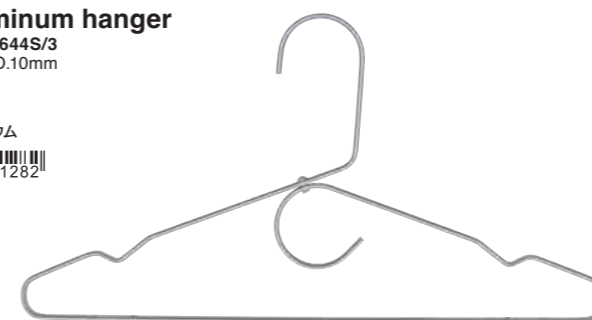

◎3本1セット

Apron with ribbon

L.850 W.1340mm
 ¥3,200+税
 材質：本体/コットン43%、ポリエステル42%、ビスコース15%
 リボン/ポリエステル100%



Red
 Model RN-0622AP/RD 4 997337 090407



Yellow
 Model RN-0622AP/YL 4 997337 090414

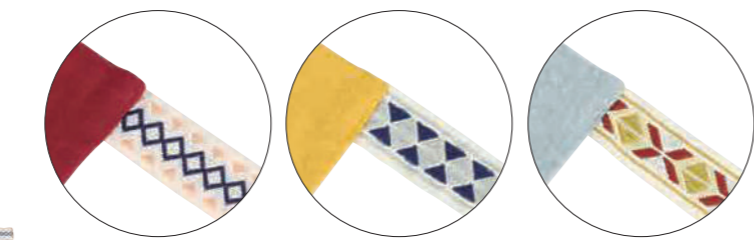

Red **Yellow** **Light gray**



Light gray
 Model RN-0622AP/GY 4 997337 090421

Garcon apron

L.800 W.800mm
 ¥2,500+税
 材質：本体/コットン43%、ポリエステル42%、ビスコース15%
 リボン/ポリエステル100%

Stripe / Navy blue
 Model RN-0623GA/NB 4 997337 090438



Stripe / Light gray
 Model RN-0623GA/GY 4 997337 090452

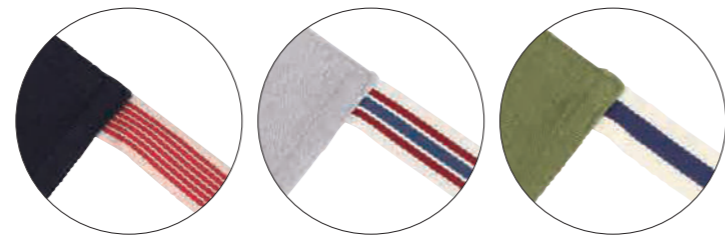
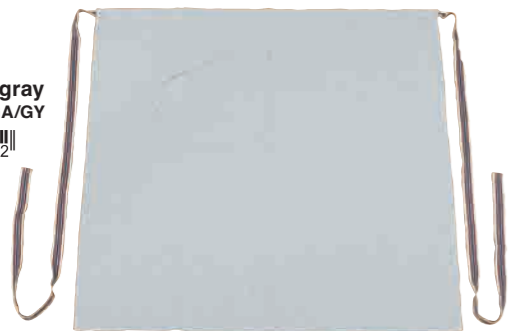

Stripe / Navy blue **Stripe / Light gray** **Stripe / Mint green**

Stripe / Mint green
 Model RN-0623GA/GN 4 997337 090445

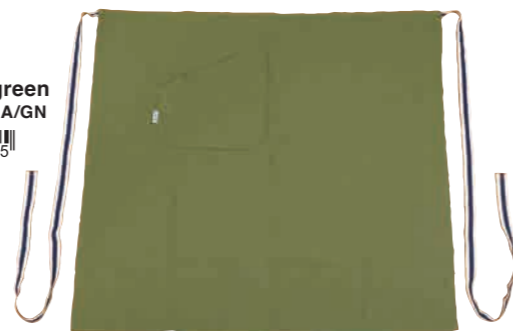

◎ハンドメイドのため、染色の際に生地が縮み、多少サイズに個体差があります。多少の色ムラ・糸のほつれ・糸飛び等があります。製品の特性としてご理解ください。
 ◎ニオイが気になる場合は、風通しの良い場所で陰干しすることにより解消されます。洗濯の際は、他の物と分けて洗ってください。





Hammock tote

材質：ポリエステル42%、コットン35%、ビスコース23%

S
H.290 W.380 D.80mm
全長 L.580mm
¥2,800+税

L
H.390 W.400 D.130mm
全長 L.680mm
¥3,300+税



Pocket

Regatta



Brown / S
Model RNZ-0619S/BR
4 997337 090117



Brown / L
Model RNZ-0619L/BR
4 997337 090193



Green / S
Model RNZ-0619S/GN
4 997337 090094



Green / L
Model RNZ-0619L/GN
4 997337 090186

Alternate



Blue / S
Model RNZ-0620S/BL
4 997337 090148



Blue / L
Model RNZ-0620L/BL
4 997337 090247



Pink x Blue / S
Model RNZ-0620S/PB
4 997337 090124



Pink x Blue / L
Model RNZ-0620L/PB
4 997337 090223

Multi



Blue / S
Model RNZ-0621S/BL
4 997337 090179



Blue / L
Model RNZ-0621L/BL
4 997337 090278



Orange x Green / S
Model RNZ-0621S/OG
4 997337 090162



Orange x Green / L
Model RNZ-0621L/OG
4 997337 090261

◎ハンドメイドのため、染色の際に生地が縮み、多少サイズに個体差があります。多少の色ムラ・糸のほつれ・糸飛び等があります。製品の特性としてご理解ください。
◎ニオイが気になる場合は、風通しの良い場所で陰干しすることにより解消されます。洗濯の際は、他の物と分けて洗ってください。

Little fishes

⇒この製品のその他のシリーズはP230に掲載されています。

材質：表地 / ポリエステル100%
中綿 / ポリプロピレン100%



◎口元にストラップ(ナスカン)付属。



Pike
Model Y-0631
L.245mm
¥1,200+税



Perch
Model Y-0632
L.190mm
¥1,200+税



Rainbow trout
Model Y-0633
L.210mm
¥1,200+税



Brown trout
Model Y-0634
L.210mm
¥1,200+税



Salmon
Model Y-0635
L.210mm
¥1,200+税



Zander
Model Y-0636
L.220mm
¥1,200+税





Metal box

材質：アイアン（粉体塗装）

S

Model RN-0625S/GY
H.75 W.120 D.250mm
¥2,900+税

4 997337 090490

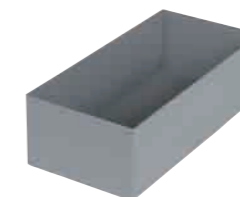

M

Model RN-0625M/GY
H.75 W.150 D.250mm
¥3,200+税

4 997337 090506

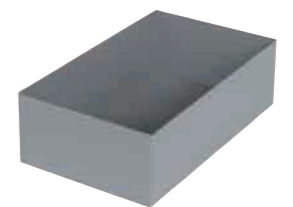

3 Divisions

Model RN-06253DV/GY
H.100 W.100 D.250mm
¥3,400+税

4 997337 090483

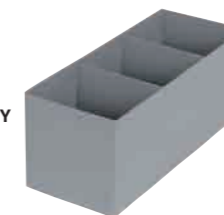

L

Model RN-0625L/GY
H.200 W.250 D.300mm
¥7,200+税

4 997337 090513

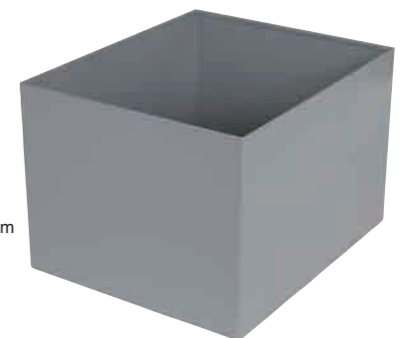

Stainless collection case

CT

Model AS-0551
H.75 φ400mm
¥17,500+税

材質：ステンレススチール(SUS202)
ガラス、シリコンゴム

4 997337 087247



ベース背面 レーザーロゴ

◎ハンドメイドのため、
大きさ・重量などに個体差があります。
◎ガラスカバーは製品工程上、
若干の歪み、シワ・気泡等が
生じる場合があります。
製品の特性としてご理解ください。



Garbage can stainless L

Model 100-106-SSL
H.440 φ330mm 24L
¥8,000+税

材質：18-0ステンレススチール

4 997337 092401

⇒この製品のその他のシリーズは
P176に掲載されています。





Table organizer



H.205 W.280 D.150mm
 Top tray: W.260 D.90mm
 Glass case: 150ml X 3pcs
 ¥6,300+税

材質：本体、ハンドル/スチール
 容器/ソーダガラス



Handle logo

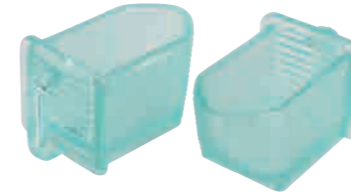

Ivory
 Model 123-384IV

4 997337 093088

◎ガラス容器は食品を入れることができますが、密閉性がない容器のため個包装されたものを推奨します。
 ◎RAWは金属素地にクリアラッカー仕上げを施しております。溶接痕や研磨跡、一部サビや擦れが見られる場合がございます。素地の色味や仕上がりの風合いに個体差があります。RAW仕上げの特性としてご理解ください。



Gray green
 Model 123-384GG

4 997337 093071

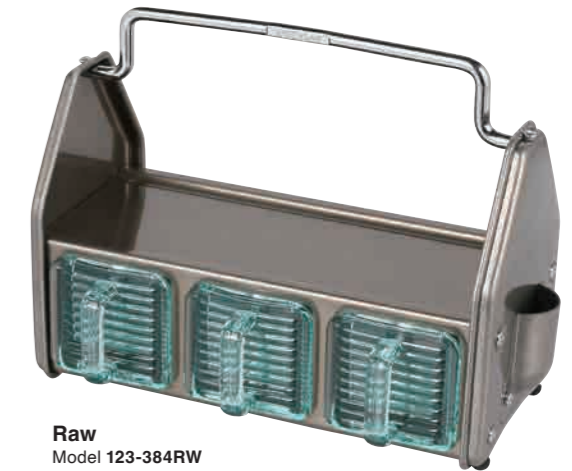

Raw
 Model 123-384RW

4 997337 093095





Kitchen timer with magnet
材質：スチール、ポリカーボネート



Gray green
Model 100-189GG
H.30 φ70mm
¥1,500+税

4 997337 093040

⇒この製品のその他の製品はP274に掲載されています。



Diet scale
材質：スチール、18-8ステンレススチール、ガラス



Gray green
Model 100-126GG
H.160 W.95mm
Tray φ120mm
Capacity 500g
¥3,400+税

4 997337 093057

⇒この製品のその他の製品はP272に掲載されています。

American kitchen scale
材質：スチール、18-8ステンレススチール、ガラス



Gray green
Model 100-061GG
H.225 W.132mm
Tray φ175mm
Capacity 1kg
¥4,500+税

4 997337 093064

⇒この製品のその他の製品はP272に掲載されています。

Little jug/Vase
材質：18-8ステンレススチール

S / 100ml
Model M-0666S
H.65 φ53mm
¥1,350+税

4 997337 092920



M / 160ml
Model M-0666M
H.105 φ53mm
¥1,680+税

4 997337 092937



L / 210ml
Model M-0666L
H.135 φ53mm
¥2,000+税

4 997337 092944



◎製品の特性上、内側に成型時の溶接線や溶接跡があります。





Porcelain jug

材質：ポーセリン



300ml
Model M-0668-300
H.105 W.155 D.96mm
¥800+税
4 997337 093019



500ml
Model M-0668-500
H.125 W.185 D.105mm
¥1,100+税
4 997337 093026



900ml
Model M-0668-900
H.140 W.210 D.130mm
¥1,800+税
4 997337 093033



◎製造工程上、色ムラ・軸ダレ等の個体差があります。斑点や釉薬上のへこみ(ピンホール)がみられる場合があります。
サイズやプリント位置等に多少の個体差があります。製品の特性としてご理解ください。
◎電子レンジ・オープン・食器洗浄機でご使用できます。直火・冷凍庫での使用はできません。



Stainless drip/water pot 1000ml

材質：本体、注ぎ口 / 304ステンレススチール
ハンドル / 201ステンレススチール

◎IH調理器・直火使用不可

⇒この製品のその他の製品は
P314に掲載されています。



Model R815-1006-1L
H.136 W.265 D.107mm
適正容量 800ml
¥3,500+税
4 997337 092814



Double lever sommelier knife "Shark"

材質：2CR13ステンレススチール、バックウッド



Model M-0665
L.137mm
¥1,800+税
4 997337 092807



◎製品の一部に
木材を使用しています。
自然素材のため
木目や色の出方に
個体差があります。



⇒この製品のその他の製品は
P307に掲載されています。



S/2 Coaster round

φ100mm×2pcs/set
 ¥780+税
 材質：ポリエステル100%
 リバーシブル

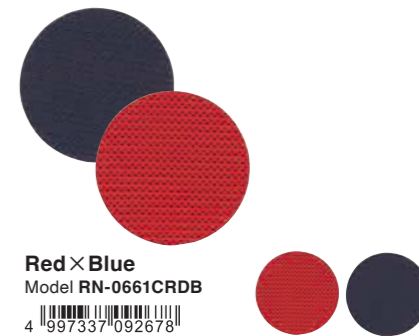
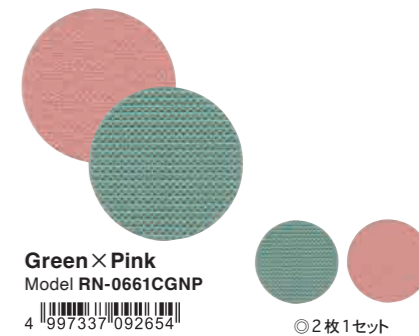

Place mat

材質：ポリエステル100%
 リバーシブル

Round
 φ380mm
 ¥900+税

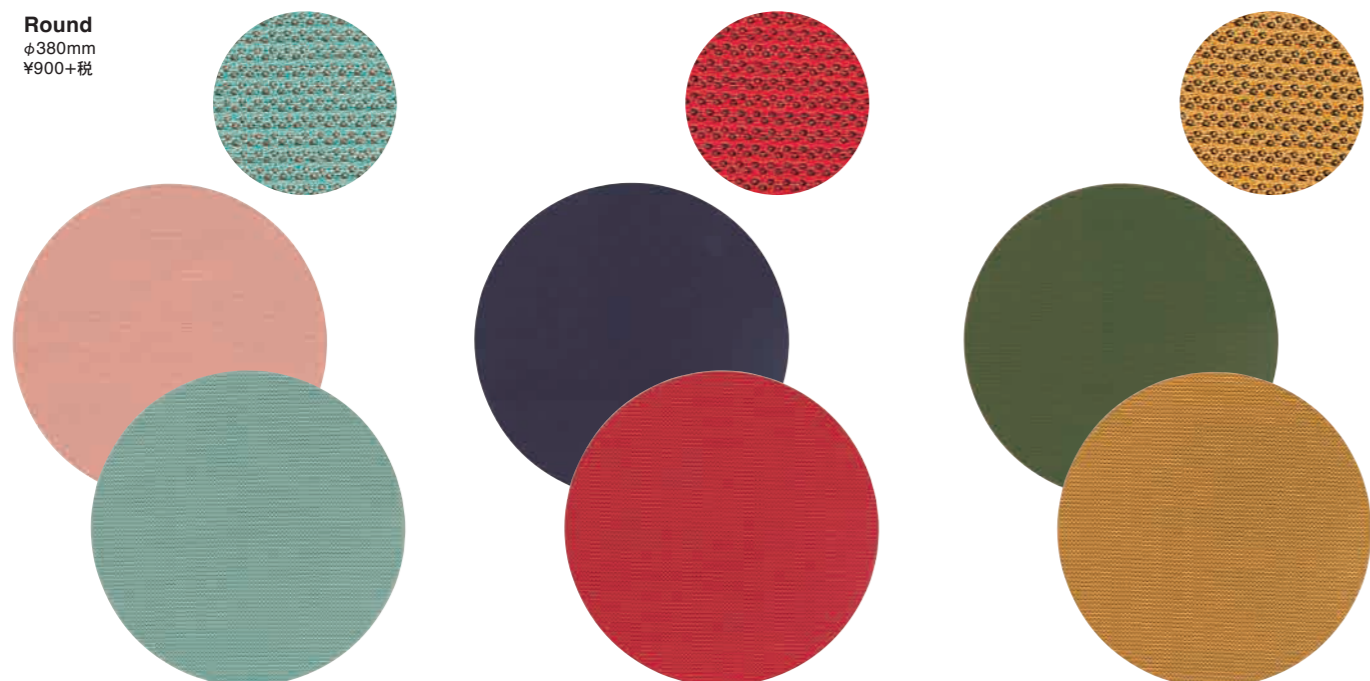

Green × Pink
 Model RN-0662PGNP 4 997337 092692

Red × Blue
 Model RN-0662PRDB 4 997337 092708

Yellow × Dark green
 Model RN-0662PYLG 4 997337 092715

Herringbone square
 480×350mm
 ¥1,000+税



Dark green × Yellow
 Model RN-0663PGNY 4 997337 092722

Gray × Purple
 Model RN-0663PGYP 4 997337 092739

Red × Navy
 Model RN-0663PNBR 4 997337 092746

GLASSES ACCESSORY



Astronaut glasses holder

H.115 W.58 D.48mm
¥2,800+税
材質：ポリレジン

Orange
Model NB-0628OR
4 997337 090599



White
Model NB-0628WT
4 997337 090582



Sage green
Model NB-0628SGN
4 997337 090605



◎眼鏡の形状・サイズによってはご使用できない場合があります。
◎眼鏡は付属しません。

Glasses case

H.175 W.80 mm
¥800+税
材質：表地 / ポリエステル
内布 / ポリエステル

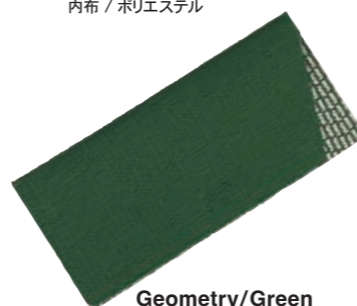

Geometry/Green
Model RN-0664GGN
4 997337 092753



Geometry/Blue
Model RN-0664GBL
4 997337 092760

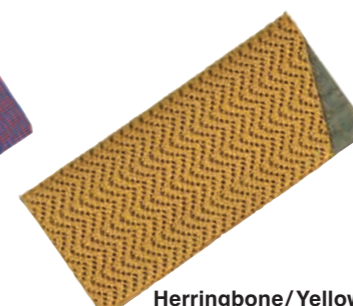

Herringbone/Yellow
Model RN-0664HYL
4 997337 092777



Herringbone/Red
Model RN-0664HRD
4 997337 092784

◎眼鏡の形状・サイズによってはご使用できない場合があります。
◎眼鏡は付属しません。

Rotating rack for Glasses

20 Glasses
Model GD-13
H.840 W.300 D.300mm
¥OPEN PRICE
材質：MDF, ミラー

4 997337 091701



卓上タイプ
10pcs×2面

50 Glasses
Model GD-14
H.875 W.440 D.440mm
¥OPEN PRICE
材質：MDF, ミラー

4 997337 091763



卓上タイプ
10pcs×5面

Display box
Model GD-16
H.512 W.180 D.107mm
¥OPEN PRICE
材質：MDF
取付用ボルト、ワッシャー各1pc付属

4 997337 091787



◎GD-15に取り付けるボックスパーツです。

100 Glasses
Model GD-15
H.1922 W.500 D.50mm
¥OPEN PRICE
材質：MDF, ミラー

4 997337 091770

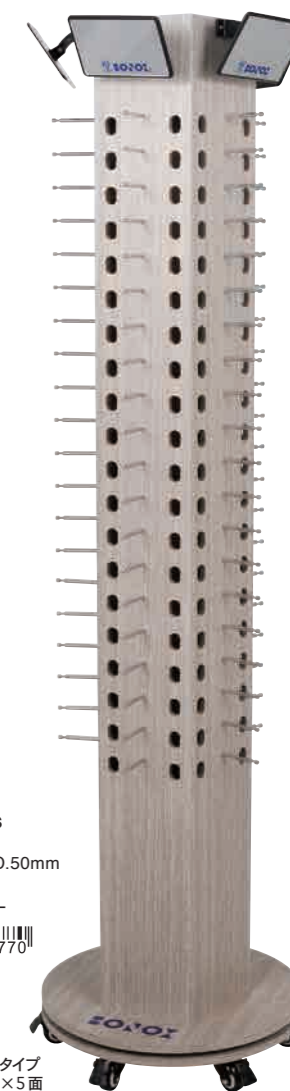

床置きタイプ
20pcs×5面

DULTON GOODS

DULTON T-shirt  ⇒この製品のその他のシリーズはP356に掲載されています。
 ¥3,600+税
 材質：コットン100%

S 着丈 62.5 / 胸囲 51.5 / 肩幅 45cm
 M 着丈 64.5 / 胸囲 55 / 肩幅 47cm
 L 着丈 66.5 / 胸囲 58.5 / 肩幅 49cm
 XL 着丈 68.5 / 胸囲 61.5 / 肩幅 51cm



Color	Size S	Size M	Size L	Size XL
○ White	T23-0645S/WT 4 997337091800	T23-0645M/WT 4 997337091862	T23-0645L/WT 4 997337091879	T23-0645XL/WT 4 997337091886
● Navy	T23-0646S/NB 4 997337091893	T23-0646M/NB 4 997337091909	T23-0646L/NB 4 997337091961	T23-0646XL/NB 4 997337091978
● Terracotta	T23-0647S/TR 4 997337091985	T23-0647M/TR 4 997337091992	T23-0647L/TR 4 997337092005	T23-0647XL/TR 4 997337092012

DULTON T-shirt DIY 
 ¥3,600+税
 材質：コットン100%

S 着丈 62.5 / 胸囲 51.5 / 肩幅 45cm
 M 着丈 64.5 / 胸囲 55 / 肩幅 47cm
 L 着丈 66.5 / 胸囲 58.5 / 肩幅 49cm
 XL 着丈 68.5 / 胸囲 61.5 / 肩幅 51cm



Color	Size S	Size M	Size L	Size XL
○ Off white	T23-0648S/OW 4 997337092036	T23-0648M/OW 4 997337092050	T23-0648L/OW 4 997337092067	T23-0648XL/OW 4 997337092074
● Light blue	T23-0649S/LB 4 997337092081	T23-0649M/LB 4 997337092098	T23-0649L/LB 4 997337092104	T23-0649XL/LB 4 997337092111
● Terracotta	T23-0650S/TR 4 997337092128	T23-0650M/TR 4 997337092135	T23-0650L/TR 4 997337092142	T23-0650XL/TR 4 997337092159



BOTANY T-shirt Saguaro 
 ¥3,600+税
 材質：コットン100%

S 着丈 62.5 / 胸囲 51.5 / 肩幅 45cm
 M 着丈 64.5 / 胸囲 55 / 肩幅 47cm
 L 着丈 66.5 / 胸囲 58.5 / 肩幅 49cm
 XL 着丈 68.5 / 胸囲 61.5 / 肩幅 51cm



Color	Size S	Size M	Size L	Size XL
● Gray	T23-0651S/GY 4 997337092166	T23-0651M/GY 4 997337092173	T23-0651L/GY 4 997337092180	T23-0651XL/GY 4 997337092197
● Charcoal	T23-0652S/CH 4 997337092203	T23-0652M/CH 4 997337092210	T23-0652L/CH 4 997337092227	T23-0652XL/CH 4 997337092234
● Mustard	T23-0653S/MS 4 997337092241	T23-0653M/MS 4 997337092258	T23-0653L/MS 4 997337092265	T23-0653XL/MS 4 997337092272





DISHWASHER, MICROWAVE AND OVEN SAFE



Land series 材質：ストーンウェア

Land round plate
LOT 4pcs



Series bottom



165

Model M-0592-165
H.22 φ170mm
¥700+税
4 997337 088084

200

Model M-0592-200
H.23 φ215mm
¥800+税
4 997337 088091

225

Model M-0592-225
H.24 φ235mm
¥900+税
4 997337 088107

250

Model M-0592-250
H.31 φ260mm
¥1,100+税
4 997337 088114

270

Model M-0592-270
H.32 φ280mm
¥1,300+税
4 997337 088121

Land oval plate
LOT 4pcs



250

Model M-0591-250
H.25 W.262 D.202mm
¥1,000+税
4 997337 088053

300

Model M-0591-300
H.28 W.320 D.235mm
¥1,500+税
4 997337 088060

350

Model M-0591-350
H.30 W.360 D.248mm
¥2,200+税
4 997337 088077



SMALL SUNDRIES



LAND ENHANCE THE COLORS OF YOUR FOOD.

DISHWASHER, MICROWAVE AND OVEN SAFE



Bottom

Land soup bowl

Model M-0589
H.43 φ230mm
320ml
¥900+税
LOT 4pcs 4 997337088039



Land large bowl

Model M-0590
H.60 φ270mm
1600ml
¥1,300+税
LOT 4pcs 4 997337088046



Bottom

Land stacking mug

Model M-0586
H.95 W.112 D.82mm
300ml
¥650+税
LOT 6pcs 4 997337088008



Land stacking cup & saucer

Model M-0587
Saucer H.22 φ155mm
Cup H.70 W.110 D.84mm
230ml
¥900+税
LOT 6pcs 4 997337088015



Land ramekin

Model M-0593
H.52 φ90mm
180ml
¥450+税
LOT 6pcs 4 997337088138



Land stacking small bowl

Model M-0588
H.54 φ115mm
300ml
¥650+税
LOT 6pcs 4 997337088022

LANDシリーズ注意事項
◎オープン・電子レンジ・食器洗浄機の使用可能。
◎素材や製造工程上、色やサイズ、形状に個体差があります。表面に波打ち凹凸や軸ダレがみられる場合があります。
◎材質の性質上、黒点や釉薬上の凹み(ピンホール)等が見られる場合があります。ご使用中に貫入が見られる場合があります。製品の特性としてご理解ください。
◎裏面のロゴは手作業で施すため、仕上がりやロゴ位置等に個体差が生じます。ロゴの「かすれ」「にじみ」等が出る場合がございますが、個体差としてご理解ください。





Doer's bookshelf

Model RVG-0578
H.1800 W.980 D.450mm
¥135,000+税
材質：スチール(粉体塗装)、チーク突板
アジャスタ付き

4 997337 087759



背面ロゴプレート

⇒このシリーズのその他の製品はP108に掲載されています。

Swing convertible table & shelf

Model GM-0608
Shelf H.1390 W.1165 D.590mm
Table H.795 W.1165 D.1500mm
¥127,000+税

材質：スチール(粉体塗装)
パイン材(ウレタン塗装)
アジャスタ付き

4 997337 089890

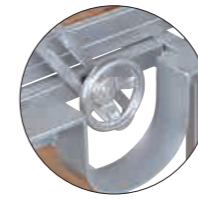

固定ハンドル



Table



Shelf

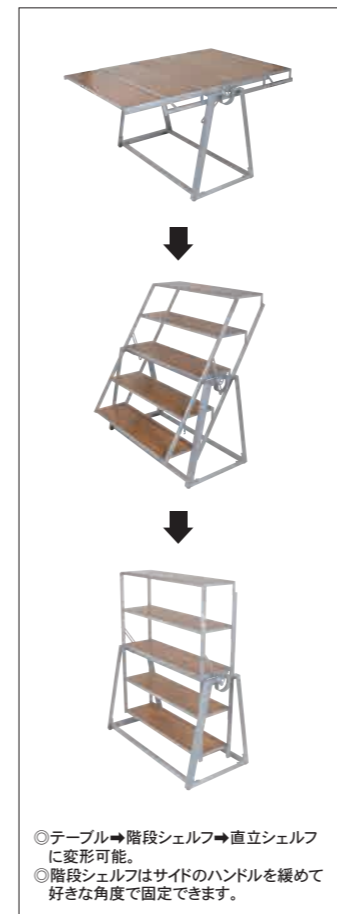

◎テーブル⇒階段シェルフ⇒直立シェルフ
に変形可能。
◎階段シェルフはサイドのハンドルを緩めて
好きな角度で固定できます。



Doer's chair

H.820 W.450 D.540mm
Seat height 440mm
¥19,300+税

材質：スチール(粉体塗装)
Mustard / ポリエステル
Stone gray / ポリウレタン



⇒既存カラーはP115に掲載されています。



脚部ロゴプレート

Stone gray
Model RVG-0490SGY
4 997337 089241



Mustard
Model RVG-0490MS
4 997337 089234





Canvas director chair

H.780 W.650 D.480mm
 Folding H.780 W.170 D.480mm
 Seat height 450mm
 ¥16,800+税

材質：アルミニウム、コットン100%



Folding



Orange

Model GZ-0626OR



4 997337 090537

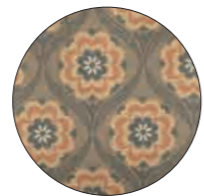

Khaki

Model GZ-0626KH



4 997337 090544



Railroad blanket

Model YZ-0618
 1900×1900mm
 ¥13,800+税

材質：ウール77%、ポリエステル23%



4 997337 090063

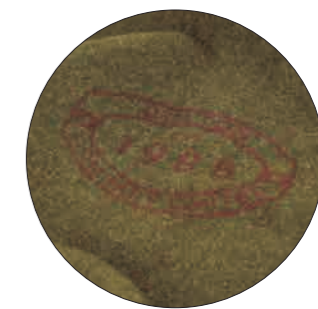

◎生産毎にサイズに多少の個体差があります。◎製品の特性上、ご使用当初は毛羽立ちなどが発生する場合がありますが次第に落ち着きます。





Fiber ladder
 材質：天板 / ポリプロピレン
 支柱 / グラスファイバー



3 steps / Orange
 Model Y-0604-3OR
 H.780 W.435 D.575mm
 Folding H.840 W.435 D.150mm
 ¥14,000+税
 4 997337 089678

5 steps / Orange
 Model Y-0604-5OR
 H.1305 W.510 D.845mm
 Folding H.1390 W.510 D.150mm
 ¥19,800+税
 4 997337 089692



3 steps / Brown
 Model Y-0604-3BR
 H.780 W.435 D.575mm
 Folding H.840 W.435 D.150mm
 ¥14,000+税
 4 997337 089685

5 steps / Brown
 Model Y-0604-5BR
 H.1305 W.510 D.845mm
 Folding H.1390 W.510 D.150mm
 ¥19,800+税
 4 997337 089708



Aluminum lamp shade
 材質：アルミニウム



L / SPACE
 Model DSZ-0596L/SP
 H.110 φ365mm
 ¥6,700+税
 4 997337 088930



CURVE
 Model DSZ-0596CV
 H.140 φ356mm
 ¥5,400+税
 4 997337 090674



©P121掲載 Model DSZ-0504
 Aluminum socket cord
 に取り付け可能です。



KITCHENWARE

SMALL SUNDRIES



Aluminum bracket

材質：アルミニウム
取付用ビス3pcs 付属



- | | | | |
|--|--|--|--|
| <p>Bracket "10"
Model Y-0535-10
H.100 W.30 D.100mm
¥1,000+税
4 997337 086561</p> | <p>Bracket "12"
Model Y-0535-12
H.125 W.30 D.125mm
¥1,200+税
4 997337 086578</p> | <p>Bracket "14"
Model Y-0535-14
H.140 W.30 D.140mm
¥1,400+税
4 997337 086585</p> | <p>Bracket "19"
Model Y-0535-19
H.195 W.35 D.195mm
¥1,800+税
4 997337 086592</p> |
|--|--|--|--|

◎ 棚板用のビスは付属しません。棚板の材質や厚さに合った市販のビスをお買い求めください。

Aluminum hook

材質：アルミニウム
取付用ビス4pcs 付属



- | | |
|---|--|
| <p>Single
Model Y-0533
H.50 W.30 D.45mm
¥680+税
4 997337 086547</p> | <p>Double
Model Y-0534
H.100 W.30 D.45mm
¥880+税
4 997337 086554</p> |
|---|--|



Aluminum door handle

材質：アルミニウム
取付用ビス4pcs 付属



- Pull**
Model Y-0532
H.120 W.90 D.60mm
¥6,000+税
4 997337 086530

⇒アルミニウムシリーズのその他の製品はカタログP210に掲載されています。

Porcelain robe hook

材質：ポーセリン
取付用ビス 2pcs 付属



- | | |
|--|---|
| <p>Model Y-0615
H.75 W.120 D.75mm
¥900+税
4 997337 089975</p> | <p>Model Y-0616
H.82 W.87 D.93mm
¥900+税
4 997337 089982</p> |
|--|---|

Porcelain shelf

材質：ポーセリン
取付用ビス 2pcs 付属



- Model Y-0612
H.70 W.590 D.135mm
¥3,600+税
4 997337 089944

Porcelain towel bar

材質：ポーセリン、201ステンレススチール
取付用ビス 4pcs 付属



- Model Y-0614
H.68 W.650 D.95mm
¥2,000+税
4 997337 089968

Porcelain toilet paper holder

材質：ポーセリン、ポリプロピレン
取付用ビス 2pcs 付属



- | | |
|---|--|
| <p>Model Y-0609
H.77 W.207 D.105mm
¥1,800+税
4 997337 089906</p> | <p>Model Y-0610
H.115 W.177 D.103mm
¥1,800+税
4 997337 089913</p> |
|---|--|

Porcelain soap dish

材質：ポーセリン
取付用ビス 2pcs 付属



- Model Y-0611S
H.65 W.200 D.115mm
¥1,500+税
4 997337 089920

Porcelain big soap dish

材質：ポーセリン
取付用ビス 2pcs 付属



- Model Y-0611L
H.80 W.242 D.135mm
¥1,800+税
4 997337 089937

Porcelain towel ring

材質：ポーセリン、201ステンレススチール
取付用ビス 2pcs 付属



- Model Y-0613
H.225 W.205 D.76mm
¥1,600+税
4 997337 089951

Porcelain hook

材質：ポーセリン
取付用ビス 2pcs 付属



- | | | |
|--|--|--|
| <p>Single hook
Model Y-0617/1
H.61 W.86 D.52mm
¥800+税
4 997337 089999</p> | <p>2 prong hook
Model Y-0617/2
H.61 W.159 D.52mm
¥1,200+税
4 997337 090001</p> | <p>3 prong hook
Model Y-0617/3
H.61 W.231 D.52mm
¥1,600+税
4 997337 090018</p> |
|--|--|--|



- | | |
|--|--|
| <p>4 prong hook
Model Y-0617/4
H.61 W.305 D.52mm
¥2,000+税
4 997337 090032</p> | <p>5 prong hook
Model Y-0617/5
H.61 W.379 D.52mm
¥2,400+税
4 997337 090056</p> |
|--|--|





On the rocks diffuser

Package H.95 W.230 D.145mm
 Coaster W.200 D.96mm
 Glass H.87 W.82 D.82mm
 ¥3,000+税

材質：天然石、ガラス



Wolf moon

Model RS23-0577WM
 Bottle H.92 W.43 D.43mm
 Fragrance : Black cardamom
 オイル容量 50ml



Fragrance tester

各香りの店頭展示サンプルをご用意しています。
 ご希望の方は営業担当までお問い合わせください。

◎お酒ではありません。天然石に氷にオイルをお酒に見立てたフレグランスです。香りをお楽しみください。
 ◎誤って飲み込まないよう十分ご注意ください。



Package "Wolf moon"

天然石

Package "Wild west"

Package "Snowy forest"



Wild west

Model RS23-0577WW
 Bottle H.116 W.35 D.35mm
 Fragrance : Red sandalwood
 オイル容量 50ml



Snowy forest

Model RS23-0577SF
 Bottle H.102 φ42mm
 Fragrance : Pure silk
 オイル容量 45ml



The gulls

材質：ポリレジン、アイアン



A
 Model NB-0605A
 H.325 W.225 D.90mm
 ¥5,600+税



B
 Model NB-0605B
 H.400 W.185 D.140mm
 ¥5,800+税



C
 Model NB-0605C
 H.370 W.235 D.90mm
 ¥5,800+税



The blue whale

材質：ポリレジン、アイアン



D
 Model NB-0605D
 H.255 W.135 D.100mm
 ¥3,800+税



Model NB-0606
 H.395 W.625 D.190mm
 ¥13,400+税



Refill bottle

材質：オイル/香料、溶剤
容器/ガラス

NEW



Wolf moon

Model RS23-0658WM
 ¥1,100+税



Wild west

Model RS23-0658WW
 ¥1,100+税



Snowy forest

Model RS23-0658SF
 ¥1,100+税



◎ On the rocks diffuserの専用のリフィルです。





The DULPEDIA 2024

CAR & OUTDOOR

FOR CAR LIFE 062

OUTDOOR 078



OR





Auto sunshade

材質：ポリプロピレン、ポリエチレン、PET、アルミ、PVCレザー



S
Model V21-0355S
H.560 W.1300 D.4mm
Folding H.560 W.130 D.50mm
¥3,200+税

- Color
- White 4 997337 085632
 - Olive 4 997337 085625
 - Gray 4 997337 085618
 - Coyote 4 997337 085601



M
Model V21-0355M
H.680 W.1300 D.4mm
Folding H.680 W.130 D.50mm
¥3,400+税

- Color
- White 4 997337 077835
 - Olive 4 997337 077866
 - Gray 4 997337 077859
 - Coyote 4 997337 085649



L
Model V21-0355L
H.780 W.1400 D.4mm
Folding H.780 W.140 D.60mm
¥3,600+税

- Color
- White 4 997337 077897
 - Olive 4 997337 077927
 - Gray 4 997337 077910
 - Coyote 4 997337 085656



◎運転手席側・助手席側のサンバイザーでサンシェードの上部を押さえてください。

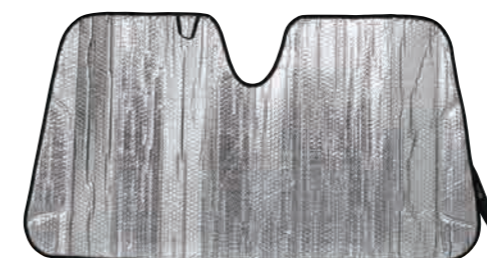

Back

Auto sunshade display box
Model V21-0409
H.685 W.150 D.390mm
4 997337 080699



◎ご希望のお客様には無償でご提供いたします。詳しくは営業担当までお問合せください。



Folding shopping basket 30L

材質：ポリプロピレン

Model V22-0505
H.310 W.480 D.280mm
Inside H.300 W.450 D.255mm
Folding H.95 W.480 D.280mm
¥3,400+税

Color
● Olive 4 997337 085557
● Gray 4 997337 085533



Olive

Gray

◎付属品
カード1枚



Card
85×54mm
材質：PP

◎製造工程上、スレや小キズが生じる場合があります。製品の特性としてご理解ください。

Folding mesh storage

材質：ポリプロピレン

11L

Model V21-0346
H.140 W.400 D.300mm
Inside H.120 W.360 D.265mm
Folding H.53 W.400 D.300mm
¥2,000+税

Color
○ White 4 997337 077200
● Red 4 997337 077217
● Navy 4 997337 077194
● Olive 4 997337 077231
● Gray 4 997337 077224



Navy



Folding

Stacking

◎V21-0346とV21-0347は
スタッキング可能です。

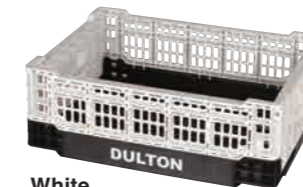

White



Red



Olive



Gray

◎付属品 カード1枚



Card 11L

85×54mm

材質：PP

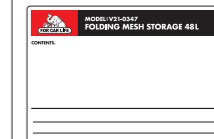

Card 48L

150×100mm

材質：PP

48L

Model V21-0347
H.260 W.600 D.400mm
Inside H.245 W.560 D.360mm
Folding H.53 W.600 D.400mm
¥4,500+税

Color
○ White 4 997337 077255
● Red 4 997337 077262
● Navy 4 997337 077248
● Olive 4 997337 077286
● Gray 4 997337 077279

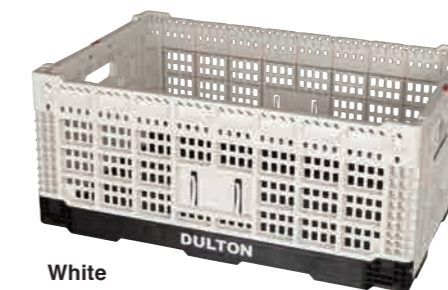

White



Red

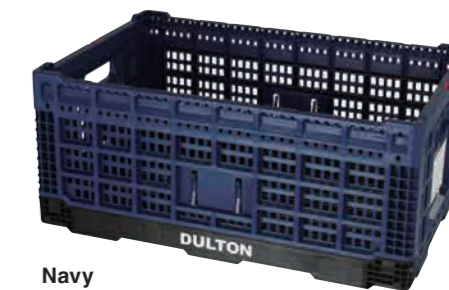

Navy



Olive

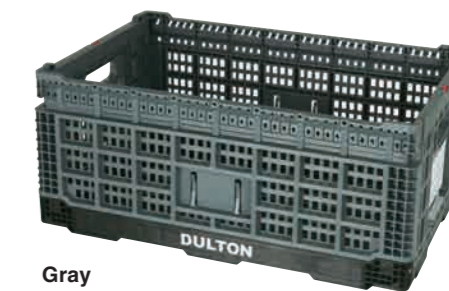

Gray





Pyramid runner mat

材質：PVC

◎車種に合わせてカットしてお使いください。

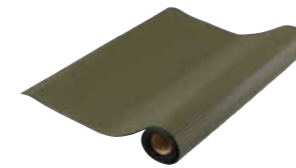

S
Model V23-0538S
H.450 W.1500 D.2mm
¥2,500+税

Color	
● Navy	4 997337 086707
● Olive	4 997337 086714
● Gray	4 997337 086691
● Coyote	4 997337 086684



L
Model V23-0538L
H.900 W.1500 D.2mm
¥5,200+税

Color	
● Navy	4 997337 086745
● Olive	4 997337 086752
● Gray	4 997337 086738
● Coyote	4 997337 086721

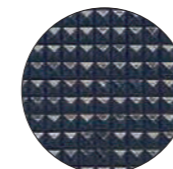

Navy

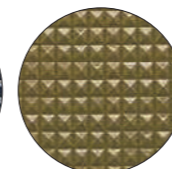

Olive

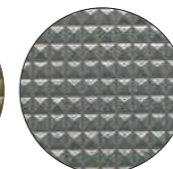

Gray

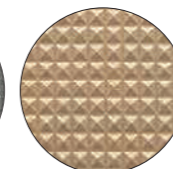

Coyote

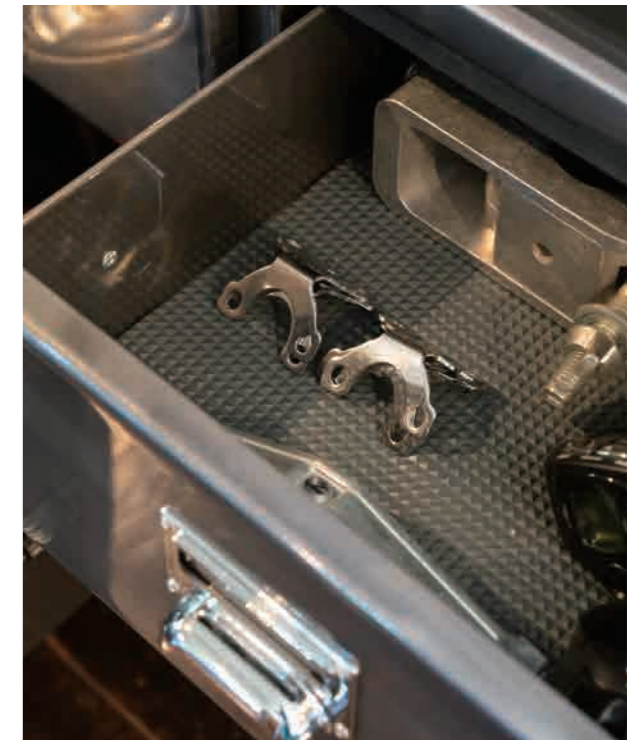

Deep tray front mat

材質：PVC



◎車種に合わせてカットしてお使いください。



Model V23-0536
H.20 W.455 D.610mm
¥2,000+税

Color	
● Navy	4 997337 086622
● Olive	4 997337 086639
● Gray	4 997337 086615
● Coyote	4 997337 086608

Deep tray rear mat

材質：PVC



Model V23-0537
H.20 W.455 D.450mm
¥1,800+税

Color	
● Navy	4 997337 086660
● Olive	4 997337 086677
● Gray	4 997337 086653
● Coyote	4 997337 086646



Folding hanger

Model 121-374
H.200 W.450 D.47mm
Folding 240×55×47mm
¥800+税

材質：スチール（粉体塗装）

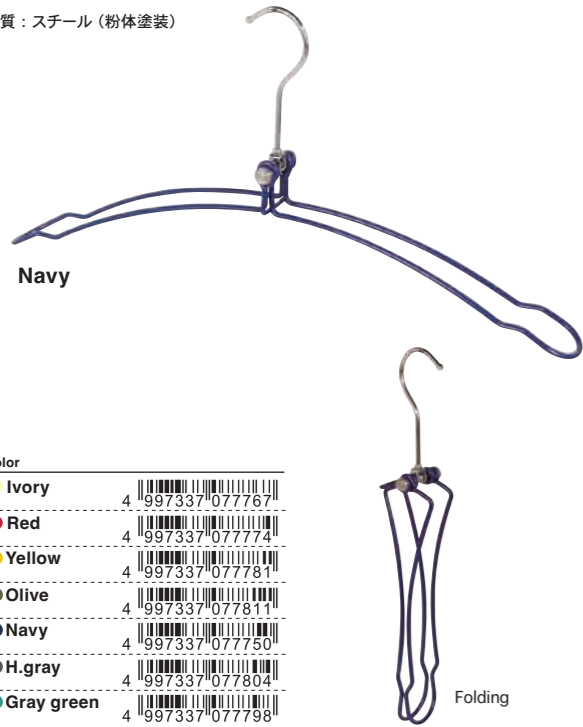

Navy

Color	Barcode
Ivory	4 997337 077767
Red	4 997337 077774
Yellow	4 997337 077781
Olive	4 997337 077811
Navy	4 997337 077750
H.gray	4 997337 077804
Gray green	4 997337 077798

Folding



One step

H.175 W.460 D.310mm
Folding H.40 W.382
D.260mm
¥4,000+税

材質：スチール（粉体塗装）
ポリプロピレン、ポリエチレン



Folding



Gray
Model V22-0435GY
4 997337 082952



Red
Model V22-0435RD
4 997337 082976



Microfiber blanket

材質：ポリエステル85%、ポリアミド15%

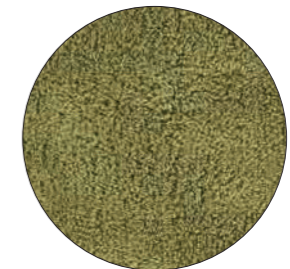

Olive



Gray

Color	Model	Size	Price
S/Olive	V21-0368S/OV	1340×800mm	¥2,500+税
S/Gray	V21-0368S/GY		
L/Olive	V21-0368L/OV	1800×1000mm	¥3,800+税
L/Gray	V21-0368L/GY		



Bottle tissue

Model V21-0350
H.145 φ66mm
Sheet size 125×180mm
120sheets (60sets)
¥280+税
材質：ハルブ、紙、ポリプロピレン
LOT 6pcs

Color	
○ White	4 997337 077477
● Red	4 997337 077484
● Olive	4 997337 077507
● Gray	4 997337 077491



Microfiber cloth

Model V21-0367
H.65 W.280 D.115mm
Cloth size 230×280mm
20 sheets
¥900+税
材質：ポリエステル85%、ポリアミド15%

Color	
○ White	4 997337 078771
● Red	4 997337 078788
● Navy	4 997337 078764
● Olive	4 997337 078801
● Gray	4 997337 078795

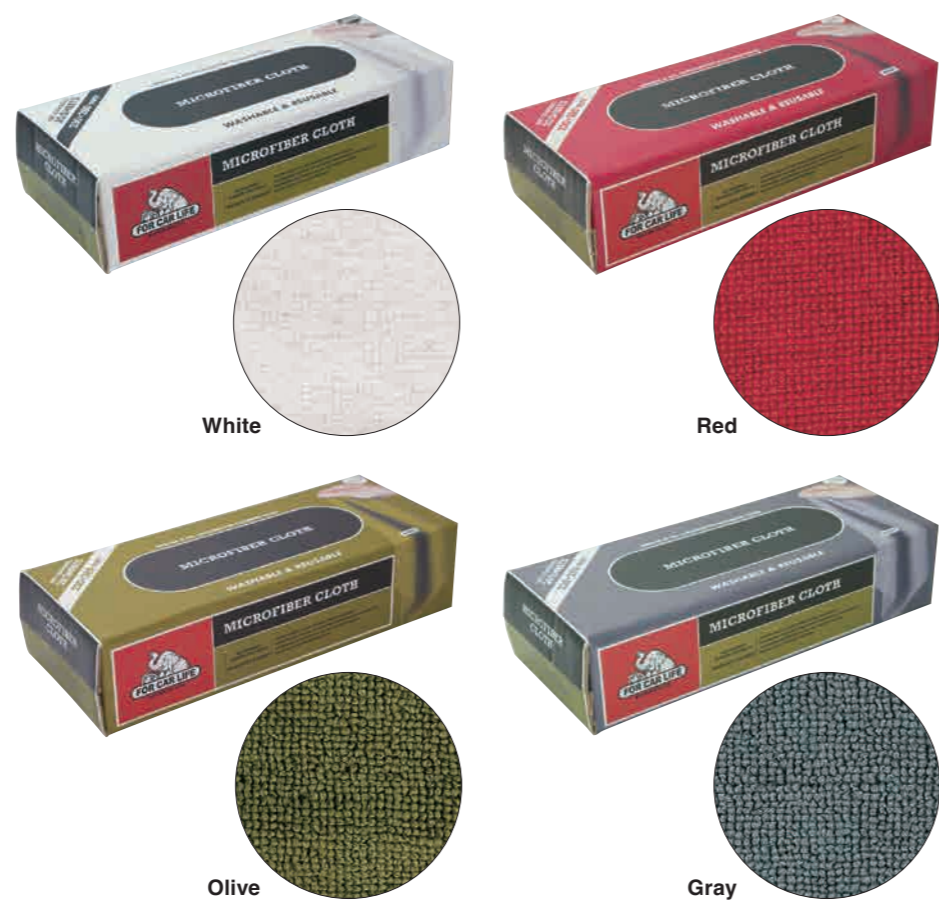

Charcoal deodorant bag

材質：竹炭、ポリエステル、ポリエステル不織布、スチール



75g set of 2

H.185 W.75 D.20mm × 2pcs set
¥200+税

200g

H.145 W.170 D.40mm
¥250+税



Gray

Model V21-0364S/GY

4 997337 078665

Natural

Model V21-0364S/NT

4 997337 078672

Gray

Model V21-0364M/GY

4 997337 078689

Natural

Model V21-0364M/NT

4 997337 078696



500g

H.200 W.200 D.50mm
¥300+税



Gray

Model V21-0364L/GY

4 997337 078702

Natural

Model V21-0364L/NT

4 997337 078719



Air freshener 
 Round type φ73mm
 Rectangle type 70×85mm
 ¥350+税
 材質：紙、香料、ゴム
 ポリエステル(紐)
LOT 12pcs



Strawberry
 Model V21-0349ST
 4 997337 077347

Back



Green apple
 Model V21-0349GA
 4 997337 077354



Pineapple
 Model V21-0349PA
 4 997337 077361



Lemon
 Model V21-0349LM
 4 997337 077378



Coconut
 Model V21-0349CO
 4 997337 077385



Sandalwood
 Model V21-0349SW
 4 997337 077392



Lavender
 Model V21-0349LV
 4 997337 077408



◎香りのテスターを貼付しております。指でこすってご確認ください。

Gel air freshener
 H.48 φ68mm 90g
 ¥400+税
 材質：香料、ポリプロピレン(容器)
 付属品 固定用両面テープ
LOT 6pcs



New car
 Model V22-0398NC
 4 997337 080453



open



close



Black ice
 Model V22-0398BI
 4 997337 080439



Silence forest
 Model V22-0398SF
 4 997337 080460



Ocean breeze
 Model V22-0398OB
 4 997337 080422



Strawberry
 Model V22-0398ST
 4 997337 080446



Ocean breeze
 Model V21-0349OB
 4 997337 077415



Silence forest
 Model V21-0349SF
 4 997337 077422



Back



Cologne
 Model V21-0349CG
 4 997337 077446



New car
 Model V21-0349NC
 4 997337 077453



Black ice
 Model V21-0349BI
 4 997337 077439

Air freshener display sheet
 Model V21-0349DB
 H.600 W.385mm
 4 997337 079426



◎ご希望のお客様には無償でご提供いたします。詳しくは営業担当までお問合せください。



Car fragrance

φ40 D.48mm
 ¥1,700+税
 材質：本体/亜鉛合金、PVC、マンガン銅
 ポリプロピレン、マグネット
 リフィル/不織布、香料、アルコール、水、溶剤
 付属品 リフィル1pc

◎使用条件により異なりますが、約1ヶ月程香りが持続します。
 ◎エアコンの送風口の仕様・形状によってはご使用できない場合があります。



Package



M.black
Black forest
 Model G975-1270MBK
 4 997337 927093



A
Magnolia orchid
 Model G975-1271A
 4 997337 927116



B
Ocean breeze
 Model G975-1271B
 4 997337 927123



C
Woody spice
 Model G975-1271C
 4 997337 927130



D
Lemon mint
 Model G975-1271D
 4 997337 927147



E
Thorns and rose
 Model G975-1271E
 4 997337 927161



F
Violet amber
 Model G975-1271F
 4 997337 927178



G
Floral chic
 Model G975-1271G
 4 997337 927185



H
Pure silk
 Model G975-1271H
 4 997337 927192

Car fragrance display stand

Model V21-0410
 H.1615 W.370 D.325mm
 材質：紙

4 997337 080705



◎ご希望のお客様には無償でご提供いたします。
 詳しくは営業担当までお問合せください。

Car fragrance refill

Model G975-1271
 φ30 D.8mm
 ¥550+税
 LOT 6pcs



Black forest	4 997337 827119
Magnolia orchid	4 997337 827133
Ocean breeze	4 997337 827140
Woody spice	4 997337 827164
Lemon mint	4 997337 827171
Thorns and rose	4 997337 827126
Violet amber	4 997337 827188
Floral chic	4 997337 827195
Pure silk	4 997337 827003

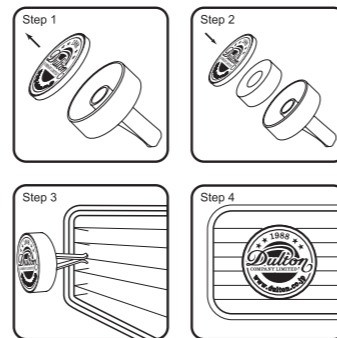

1. 製品の前面カバーを外します。
 2. 付属のレフィルを開封し、中に入れます。
 3. 車内のエアコン送風口にクリップを差し込みます。
 4. エアコンを使用すると、香りがします。

Fragrance tester 各香りの店頭展示サンプルをご用意しています。ご希望の方は営業担当までお問い合わせください。







Aluminum folding chair



Model Y-0444
 H.774 W.555 D.606mm
 Folding H.840 W.555 D.130mm
 Seat height 395mm
 ¥26,000+税
 材質：アルミニウム、WPC
 4 997337 083218



Folding

Ice chest 20L Dark green

Model YZ-0432DGN
 H.295 W.480 D.280mm
 Inner H.240 W.405 D.205mm 20L
 ¥15,800+税
 材質：スチール(粉体塗装)、内側/アルミニウム
 4 997337 081344



Inside

Lock



Unlock



Bottle opener



◎保冷時間 24h (JIS規格簡便法を基に比例計算)
 保冷性能は、投入する保冷剤や内容物の量や温度、周囲の環境やフタの開閉回数等に影響されます。



Tin basket
 H.160 W.335 D.245mm
 容量 約10L
 ¥3,800+税
 材質：ブリキ



Blue
 Model XRZ-0441BL
 4 997337 083119

Mustard
 Model XRZ-0441MS
 4 997337 083072

Red
 Model XRZ-0441RD
 4 997337 083065

Tin basket round
 H.300 W.250 D.230mm
 容量 約12L
 ¥4,000+税
 材質：ブリキ



Blue
 Model XRZ-0603BL
 4 997337 089661

Mustard
 Model XRZ-0603MS
 4 997337 089654

Red
 Model XRZ-0603RD
 4 997337 089647

Plaid print tablecloth 

1400×1100mm
¥1,500+税
材質：ポリエステル85%、コットン15%



Red
Model MZ-0456RD 4 



Mustard
Model MZ-0456MS 4 

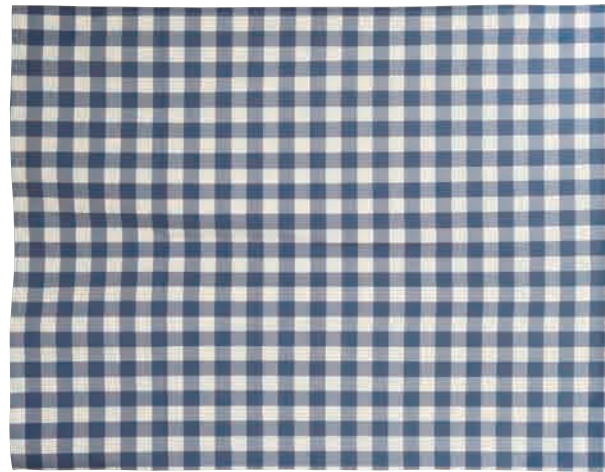

Blue
Model MZ-0456BL 4 



Back



◎裏面の四隅のポケットは小石等の「重し」を入れてご使用いただけます。

◎製造工程上、色や柄およびサイズや縫い目に個体差が生じます。
◎生地表面に白い斑点があります。生地の特性としてご理解ください。



SS rim enameled mug 

H.82 W.120 D.93mm
360ml
¥900+税
材質：エナメル、スチール
304ステンレススチール

LOT 4pcs



Bottom



Red / Black
Model Y-0443RBK
4 



Black / Green / Black
Model Y-0443BGB
4 



Green / Red
Model Y-0443GRD
4 



Green / Red / Green
Model Y-0443GRG
4 

◎電子レンジ・食器洗浄機の使用はできません。
◎製造工程上プリントの発色や位置等に個体差が生じます。
製品特性としてご理解ください。

S/3 SS Bag clip 

材質：本体/430ステンレススチール、
スプリング/201ステンレススチール



Model RN-0426S/3
H.62 W.76 D.30mm / pc
3pcs / set
¥800+税
4 



Package



Long
Model RN-0426L/3
H.72 W.120 D.37mm / pc
3pcs / set
¥1,000+税
4 



Package





天板裏レーザーロゴ



Beer table

130 / Dark green
 Model F21-0396S/DGN
 H.750 W.1290 D.495mm
 Folding H.66 W.1290 D.495mm
 ¥21,000+税

材質：天然木(モミ材)、スチール(粉体塗装)
 ポリプロピレン

4 997337 080323



Beer table

180 / Dark green
 Model F21-0396L/DGN
 H.750 W.1790 D.495mm
 Folding H.55 W.1790 D.495mm
 ¥24,000+税

材質：天然木(モミ材)、スチール(粉体塗装)
 ポリプロピレン

4 997337 080354



Beer bench

130 / Dark green
 Model F21-0397S/DGN
 H.450 W.1290 D.245mm
 Folding H.57 W.1290 D.245mm
 ¥13,000+税

材質：天然木(モミ材)、スチール(粉体塗装)
 ポリプロピレン

4 997337 080347



Beer bench

180 / Dark green
 Model F21-0397L/DGN
 H.450 W.1790 D.245mm
 Folding H.57 W.1790 D.245mm
 ¥17,500+税

材質：天然木(モミ材)、スチール(粉体塗装)
 ポリプロピレン

4 997337 080378

Felt banner

材質：ポリエステル100%、天然木
 付属品：ロープ



Right here
 Model RNZ-0539/RH
 H.450 W.300mm
 ¥4,400+税

4 997337 086769



Take it by stride
 Model RNZ-0539/TIBS
 H.450 W.300mm
 ¥4,400+税

4 997337 086776



Ignite the mind
 Model RNZ-0539/ITM
 H.450 W.300mm
 ¥4,400+税

4 997337 086783



Never the same
 Model RNZ-0539/NTS
 H.650 W.495mm
 ¥6,800+税

4 997337 086790



◎ハンドメイドのため、サイズやデザインの位置に多少のバラつきがあります。
 ◎糸のほつれや糸飛び等も生じる場合がありますが、製品の特性としてご理解ください。
 ◎直射日光の当たる場所で長期間使用すると、紫外線により退色することがあります。



Towel blanket

1000×1000mm
¥6,800+税
材質：コットン100%



A
Model XR23-0544A
4 997337 087025



B
Model XR23-0544B
4 997337 087032



C
Model XR23-0544C
4 997337 087049



◎ジャガード織。
◎タンブラー乾燥機のご使用はお避けください。
◎素材の特性上、使用や洗濯により収縮することがあります。
◎パイルが引き抜けた場合、すぐにその部分のパイル糸を引っ張らず、根元からハサミで切ってください。

Wax canvas field cloth

材質：コットン100% (ワックス加工)、真鍮

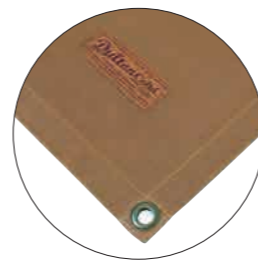

S / Camel G20-0274S/CAM 680×1000mm ¥2,300+税 4 997337 072908
L / Camel G20-0274L/CAM 1000×1400mm ¥3,600+税 4 997337 072922

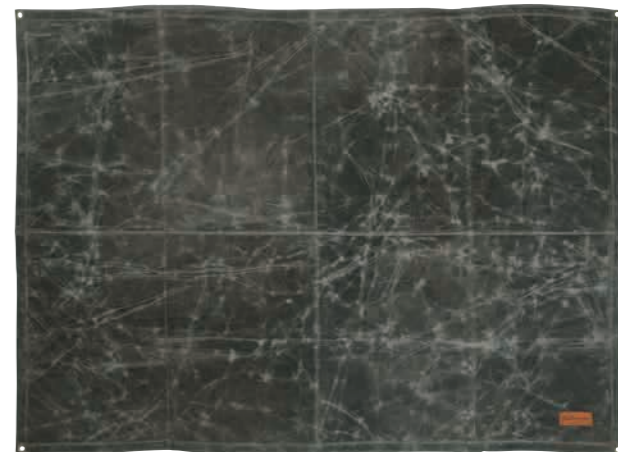
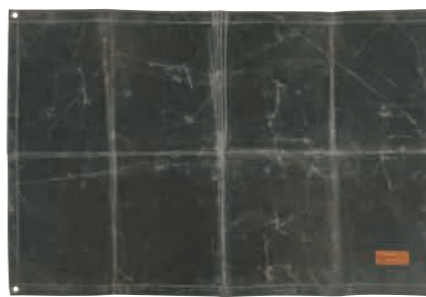

S / Olive G20-0274S/OV 680×1000mm ¥2,300+税 4 997337 072892
L / Olive G20-0274L/OV 1000×1400mm ¥3,600+税 4 997337 072915

◎両面にパラフィン加工が施されています。パラフィン加工の特性として、表面にヒビや割れシワ(チョークマーク)があります。
◎ハンドメイドのため、生産毎にサイズや風合い、色の濃淡やチョークマークのつき方に大きく個体差があります。製品の特性としてご理解ください。
◎チョークマークはパラフィン加工独特の味わいの一つですが、アイロンを当てることで目立たなくさせることができます。アイロンをかける場合は必ず当て布をしてください。



Stainless drum

材質：202ステンレススチール(サテン仕上げ)



Model YZ-0408
H.370 φ330mm
Inner H.330 φ286mm
耐荷重 100kg
¥9,800+税



4 997337 080682



Mosquito coil holder

Model H21-0307
H.110 W.175 D.165mm
¥1,800+税

材質：ガルバニイズドスチール
ステンレススチール、マグネット



Color	Barcode
Galvanized	4 997337 075190
Ivory	4 997337 079594
Red	4 997337 079624
Yellow	4 997337 079617
Dark green	4 997337 079600



Galvanized



Ivory



Folding



Red



Yellow



Dark green



Portable ashtray



Indian

Model K655-757ND
H.20 W.70 D.70mm
¥1,200+税

4 997337 575713



Package



Emergencia

Model K655-757EM
H.16 W.50 D.50mm
¥800+税

4 997337 575737



Package



Wapiti

Model K655-757WP
H.21 W.60 D.44mm
¥1,000+税

4 997337 575720



Package



Aluminum container "CONVOY 2" RL



材質：アルミニウム、スチール

◎同サイズ3つまでスタッキングが可能です。

◎H21-0352 Aluminum container "CONVOY 2"の後継品です。
H21-0352とは製品サイズ(XL以外)が異なります。
H21-0352とはスタッキング(XL以外)できかねますのでご了承ください。



プレートデザイン

S

Model H23-0667S
H.235 W.550 D.295mm
¥16,000+税



M

Model H23-0667M
H.285 W.640 D.360mm
¥20,000+税



L

Model H23-0667L
H.345 W.780 D.425mm
¥27,000+税



XL

Model H23-0667XL
H.395 W.900 D.495mm
¥38,000+税



The DULPEDIA 2024

FURNITURE

Home Furniture 096

Garden Furniture 124

Store fixtures 130





NEVER
THE SAME



Cup board

Model 122-379
 H.985 W.780 D.420mm
 Door inside H.340 W.710 D.360mm
 Drawer inside (上段) H.100 W.310 D.345mm
 Drawer inside (下段) H.210 W.310 D.345mm
 Glass board 700×320mm



◎棚板：強化ガラス×1枚



Color	Price	Barcode
● Raw	¥95,000+税	4 997337 086271
● Ivory	¥88,000+税	4 997337 086288

5 layer cabinet with drawer

Model 122-380
 H.950 W.400 D.295mm
 Door inside H.710 W.340 D.260mm
 Drawer inside H.60 W.310 D.245mm
 Glass board 330×230mm



Color	Price	Barcode
● Raw	¥48,000+税	4 997337 086295
● Ivory	¥44,000+税	4 997337 086301

◎棚板：強化ガラス×5枚

Trash can "Doubledecker"

Model 100-133
H.890 W.400 D.290mm
Inner bucket 15.8L/each



Color	Price	Barcode
● Raw	¥36,000+税	4 997337 073127
● Galvanized		4 997337 913393
● Ivory		4 997337 130103
● Yellow	¥32,000+税	4 997337 130301
● H.gray		4 997337 130806

2 layer cabinet

Model 119-349
H.895 W.760 D.430mm
Drawer H.60 W.300 D.305mm
Door inside H.315 W.690 D.345mm
Board H.15 W.685 D.325mm



Color	Price	Barcode
● Raw	¥77,000+税	4 997337 934916
● Ivory	¥70,000+税	4 997337 934923

5 drawers chest

Model 100-135
H.890 W.400 D.300mm
Drawer H.100 W.310 D.245mm



Color	Price	Barcode
● Raw	¥40,000+税	4 997337 113595
● Ivory	¥35,000+税	4 997337 113519

2 columns by 5 drawers

Model 100-164
H.950 W.770 D.420mm
Drawer H.100 W.310 D.345mm



Color	Price	Barcode
● Raw	¥98,000+税	4 997337 164009
● Ivory	¥88,000+税	4 997337 164115

3 columns by 5 drawers

Model 100-165
H.950 W.1150 D.420mm
Drawer H.100 W.310 D.345mm



Color	Price	Barcode
● Raw	¥135,000+税	4 997337 165006
● Ivory	¥120,000+税	4 997337 165112





Locker 65

Model 119-346-65
H.1600 W.560 D.545mm
Board W.510 D.475mm / 3pcs
◎棚板：スチール棚×4段 ◎施錠可能



Color	Price	Barcode
● Raw	¥93,000+税	4 997337 346610
● Ivory	¥88,000+税	4 997337 346627
● Olive drab	¥88,000+税	4 997337 346634

Low table 90

Model 100-192-9
H.405 W.955 D.525mm
Drawer H.45 W.780 D.435mm
Glass top 710×380mm
◎天板：強化ガラス



Color	Price	Barcode
● Raw	¥39,000+税	4 997337 073219
● Ivory	¥37,000+税	4 997337 073196
● Olive drab	¥37,000+税	4 997337 073226



Low table 120

Model 100-192-12
H.405 W.1255 D.525mm
Drawer H.45 W.1080 D.435mm
Glass top 1010×380mm
◎天板：強化ガラス



Color	Price	Barcode
● Raw	¥42,000+税	4 997337 073172
● Ivory	¥40,000+税	4 997337 073165
● Olive drab	¥40,000+税	4 997337 073189

Mini triangle cabinet

Model 120-357
H.460 W.450 D.278mm
Shelf board 350×190mm



Color	Price	Barcode
● Raw	¥33,000+税	4 997337 068826
● Ivory	¥30,000+税	4 997337 068833

Mini triangle cabinet H660

Model 120-356
H.660 W.450 D.278mm
Shelf board 350×190mm



Color	Price	Barcode
● Raw	¥35,000+税	4 997337 064606
● Ivory	¥32,000+税	4 997337 068802



Low cabinet

Model 115-322
H.520 W.1800 D.400mm
Glass board 570×340mm
Drawer (上段) H.95 W.520 D.340mm
Drawer (下段) H.180 H.120* W.520 D.340mm
*仕切り壁の高さ

◎棚板：強化ガラス×2枚
◎背面コードホール有り



Color	Price	Barcode
● Raw	¥120,000+税	4 997337 322508
● Ivory	¥100,000+税	4 997337 322515

Low cabinet 120

Model 120-355
H.520 W.1200 D.400mm
◎棚板：強化ガラス×2枚



Color	Price	Barcode
● Raw	¥77,000+税	4 997337 068895
● Ivory	¥72,000+税	4 997337 068888



Master sofa brown

材質：張地/本革 脚部/スチール
クッション材/ウレタンフォーム
フェザー、ポリエステル



2 seater

Model GM-0405
H.670 W.1680 D.1000mm
Seat height 450mm
¥300,000+税

4 997337 080637



Back



ロゴプレート



3 seater

Model F20-0272
H.670 W.2040 D.1000mm
Seat height 450mm
¥350,000+税

4 997337 072878



"WRIGHT" Coffee table

H.397 W.1000 D.520mm
 材質：アッシュウッド、強化ガラス
 2cartons for one set



Clear
 Model YR-0522CL
 ¥64,000+税 4 997337 086158



ロゴプレート

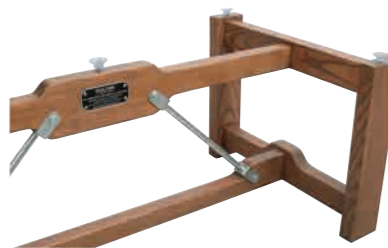

◎天然木を使用しているため木目や色の出方に個体差があります。
 製品の特性としてご理解ください。



Amber
 Model YR-0522AM
 ¥67,000+税 4 997337 086165

"WRIGHT" Dining table

材質：ホワイトオーク材、スチール
 2cartons for one set

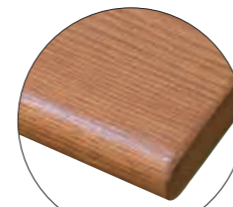

White oak

1600
 Model YR-0423-16
 H.720 W.1600 D.850mm
 ¥160,000+税
 4 997337 081092

1800
 Model YR-0423-18
 H.720 W.1800 D.900mm
 ¥170,000+税
 4 997337 081115

◎画像はModel YR-0423-16です。
 ◎天然木を使用しているため木目や色の出方に個体差があります。
 製品の特性としてご理解ください。

Doer's dining table

Model RVG-0491
 H.720 W.1500 D.800mm
 ¥89,500+税
 材質：スチール(粉体塗装)
 チーク突板
 アジャスタ付き



天板底面ロゴプレート



Doer's desk

Model RVG-0523
 H.720 W.1200 D.600mm
 Drawer H.60 W.355 D.445mm
 Hole 5mm Pitch 30mm
 ¥98,000+税
 材質：スチール(粉体塗装)
 チーク突板
 アジャスタ付き



側面ロゴプレート



◎引き出しはデスクの設置方向に合わせて反転して取り付けることができます。



◎サイドはベグボード仕様です。



Working desk

H.740 W.1200 D.600mm

材質：Raw/スチール(ラッカー塗装)
Blue/スチール(粉体塗装)
メラミン化粧板、アルミニウム
アジャスタ付き



Raw

Model F21-0391RW
¥35,000+税



4 997337 086189



Blue

Model F21-0391
¥32,000+税



4 997337 079792

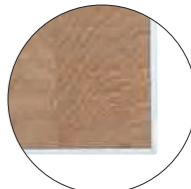

Raw

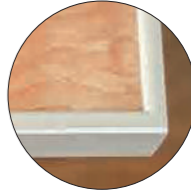

Blue

© RawとBlueの
天板色は異なります。





Standard chair

Model 100-214
H.810 W.435 D.470mm
Seat height 465mm



Color	Seat color	Price
● H.D Galvanized	Black	¥32,000+税
● Raw	Black	¥29,000+税
● Ivory	Brown	
● H.gray	Black	¥25,000+税
● Gray green	Black	

Standard bar chair

Model 100-213
H.1040 W.420 D.495mm
Seat height 750mm



Color	Seat color	Price
● H.D Galvanized	Black	¥34,000+税
● Raw	Black	¥31,000+税
● Ivory	Brown	
● H.gray	Black	¥26,000+税
● Gray green	Black	

Light-45 stool

Model 113-300
H.450 W.375 D.375mm
Seat size 290×290mm
Seat height 450mm



Color	Seat color	Price
● H.D Galvanized	Black	¥14,800+税
● Raw	Black	¥13,400+税
● Ivory	Brown	
● H.gray	Black	¥12,000+税
● Gray green	Black	

Kitchen stool

Model 112-281
H.460 W.415 D.270mm
Seat height 435mm



Color	Price
● H.D Galvanized	¥18,000+税
● Raw	¥17,000+税
● Ivory	
● Red	
● H.gray	¥15,000+税
● Gray green	

Stool "Clipper II"

Model 100-253
H.440~480 W.385 D.350mm
Seat height 435~475mm



Color	Price
● Chrome	¥16,000+税
● Raw	¥13,000+税
● Ivory	
● H.gray	¥11,000+税

Aluminum chair

Aluminum chair

Model AG-0424
H.840 W.390 D.540mm
Seat height 470mm
¥27,000+税
材質：アルミニウム、PVC



Aluminum arm chair

Model AG-0424ARM
H.840 W.555 D.540mm
Seat height 470mm
¥33,000+税
材質：アルミニウム、PVC



Aluminum standard chair

Model ALC0255-3
H.840 W.390 D.520m
Seat height H.465mm
¥23,000+税



Aluminum bar stool

Model ALC802C
H.1120 W.440 D.540mm
Seat height H.760mm
¥28,000+税



Doer's chair

H.820 W.450 D.540mm
Seat height 440mm
¥19,300+税



脚部ロゴプレート

Iron stool

Model S245-86ABK
H.600~800 W.350 D.350mm
Seat φ340mm
¥18,000+税



◎アンティークの雰囲気を出す為の仕上げ(色ムラ・塗装はがれ等)が施されており、塗装の風合いに多少の個体差があります。設置面に「サビ」が色移りする場合があります。設置箇所にはご注意ください。
◎座面には天然木が使用されている為、色や風合い等に個体差があります。製品の特性としてご理解ください。



Brown

Model RVG-0490BR

材質：スチール(粉体塗装)
ポリウレタン



Gray

Model RVG-0490GY

材質：スチール(粉体塗装)
ポリエステル



Utility rack

H.1450 W.605 D.500mm
¥14,000+税



材質：スチール(粉体塗装)、アルミニウム



脚部エンボスロゴ



Side



Ivory
Model AS-0411IV
4 997337 080712



Gray
Model AS-0411GY
4 997337 080729



Olive drab
Model AS-0411OV
4 997337 081078



Z rack

H.1800 W.1000 D.505mm
¥15,000+税
材質：スチール

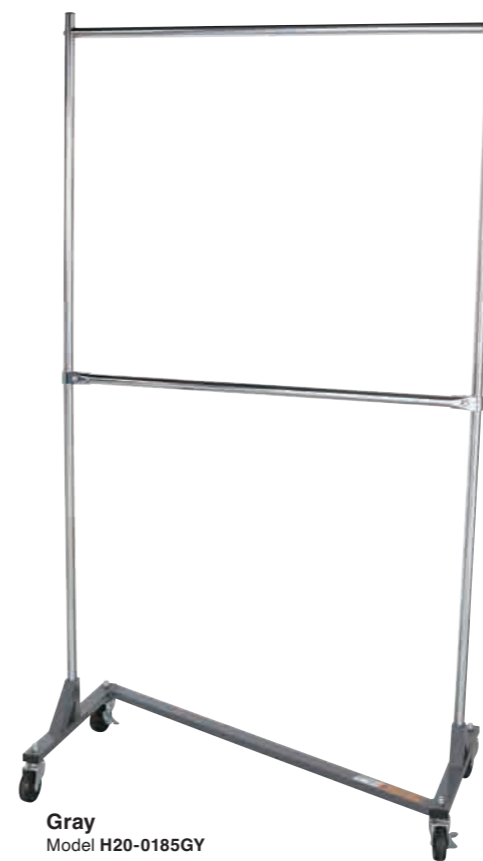

Gray
Model H20-0185GY
4 997337 067607

Mini Z rack

H.1600 W.600 D.505mm
¥11,000+税
材質：スチール

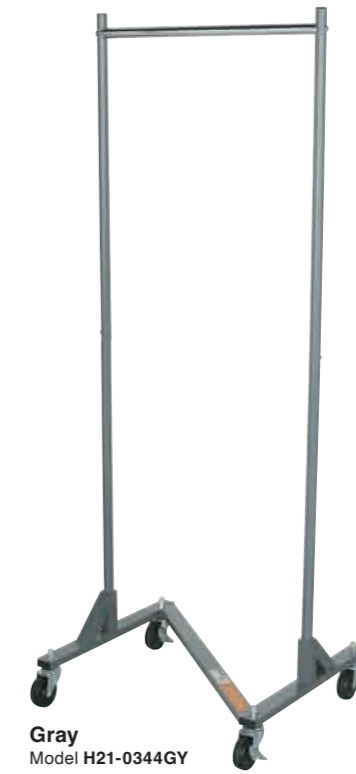

Gray
Model H21-0344GY
4 997337 077163



Ivory
Model H21-0344IV
4 997337 077156



Laundry cart with pole rack

H.1660 W.600 D.450mm
Basket: H.290 W.600 D.450mm



Chrome
Model H20-0139CR
¥35,000+税
材質：スチール(クロムメッキ)
4 997337 065788



Ivory
Model H20-0139IV
¥33,000+税
材質：スチール(粉体塗装)
4 997337 065795

Laundry cart

H.700 W.600 D.450mm
Basket: H.290 W.600 D.450mm



Chrome
Model H20-0140CR
¥32,000+税
材質：スチール(クロムメッキ)
4 997337 065801



Ivory
Model H20-0140IV
¥30,000+税
材質：スチール(粉体塗装)
4 997337 065818

Laundry trolley

H.990 W.535 D.375mm
Basket A: H.275 W.390 D.270mm
Basket B: H.405 W.390 D.270mm



Gray
Model H20-0143GY
¥18,800+税
材質：スチール(粉体塗装)
4 997337 065986



Ivory
Model H20-0143IV
¥18,800+税
材質：スチール(粉体塗装)
4 997337 065962



Raw
Model H20-0143RW
¥19,800+税
材質：スチール(無塗装クリア仕上げ)
4 997337 065993



SS Frame mirror with bracket S
 Model RN-0413
 H.500 W.370 D.130mm
 Weight 2.48kg
 ¥9,000+税
 材質：304ステンレススチール、ガラス
 4 997337 080781

Stainless steel frame mirror with bracket 
 Model D19-0057
 H.600 W.800 D.130mm
 Weight 8.8kg
 ¥17,000+税
 材質：304ステンレススチール、ガラス
 4 997337 059510



Stainless steel cabinet 
 Model D19-0058
 H.500 W.355 D.130mm
 Weight 3.88kg
 ¥14,000+税
 材質：304ステンレススチール、ガラス
 4 997337 059527



Mirror with steel frame Satin finish 
 Model D19-0059ST
 H.450 W.450 D.100mm
 Weight 4.38kg
 ¥18,000+税
 材質：304ステンレススチール、ガラス
 4 997337 059541



Aluminum pendant lamp with glass cover
 Model 100-093
 H.170 φ162mm
 Cord 1100mm
 Weight 0.5kg
 ¥5,400+税
 定格電圧：100V
 使用電球：白熱電球 MAX 40W / E26
 LED電球 MAX 4W / E26

◎電球は付属しません。



Color
 ● Aluminum 4 997337 009300
 ● Ivory 4 997337 009317
 ● Red 4 997337 009324



Aluminum socket cord 
 Model DSZ-0504
 L.1170mm
 Socket cover φ55 H.84mm
 Ceiling cup φ80 H.75mm
 Cord 970mm
 Weight 0.4kg
 定格電圧：100V
 使用電球：LED電球 MAX 15W / E26
 ¥7,800+税
 材質：アルミニウム

Color
 ● Brown 4 997337 085472
 ● Black 4 997337 085489
 ● Gray 4 997337 085496
 ● Red 4 997337 085502

◎LED電球専用です。
 ◎電球は付属しません。
 ◎製造工程上、仕上がりに個体差があります。



Cord Color

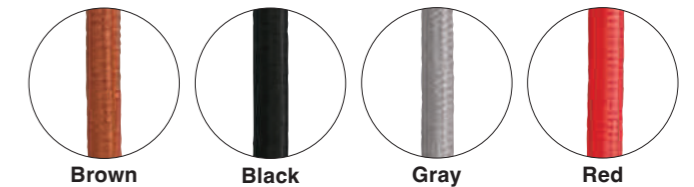



Wall lamp "Glass stick"



S
Model 100-207S
H.350 W.100 D.140mm
Weight 2.5kg
定格電圧: 100V
使用電球:
白熱電球 MAX 40W / E26×2pcs
LED電球 MAX 4W / E26×2pcs
¥15,500+税
4 997337 120715

L
Model 100-207L
H.415 W.100 D.140mm
Weight 3.5kg
定格電圧: 100V
使用電球:
白熱電球 MAX 40W / E26×2pcs
LED電球 MAX 4W / E26×2pcs
¥16,000+税
4 997337 120739

Galvanized lamp
Model 113-288
H.1030 φ260mm
¥21,000+税
定格電圧: 100V
使用電球:
白熱電球 MAX 20W / E26
LED電球 MAX 4.4W / E26
4 997337 132886



Wall lamp "Glass stick" white



S
Model 100-207WTS
H.350 W.100 D.140mm
Weight 2.5kg
定格電圧: 100V
使用電球:
白熱電球 MAX 40W / E26×2pcs
LED電球 MAX 4W / E26×2pcs
¥15,500+税
4 997337 068925

L
Model 100-207WTL
H.415 W.100 D.140mm
Weight 3.5kg
定格電圧: 100V
使用電球:
白熱電球 MAX 40W / E26×2pcs
LED電球 MAX 4W / E26×2pcs
¥16,000+税
4 997337 068918



◎室内用です。◎電球は付属しません。

Single spin canvas blades



Off white
Model DT18-CF08OW
Weight 10kg
¥63,000+税
定格電圧: 100V
4 997337 180818

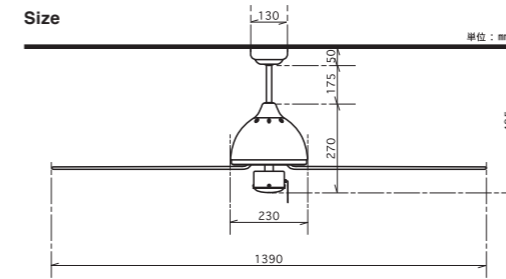

- ◎ライティングキット・コントローラーキットは別売りです。
- ◎速度調節スイッチは本体に付いています。(チェーン部分)
- ◎プラグと電気コードは付属しません。

SPEED	RPM		Watt		Amp	
	50Hz	60Hz	50Hz	60Hz	50Hz	60Hz
HIGH	87	75	34	41	0.36	0.42
MEDIUM	62	63	24	27	0.3	0.36
LOW	34	31	7	9	0.17	0.18

【取り付け箇所に関する注意】天井取り付け専用です。壁面には取り付けられません。

- ◎調光器が取り付けられている回路でご使用になりますとファンやランプの寿命を縮めたり、異常回転による振動が発生したりする原因となります。
- ◎障害物がある場所への設置はリモコンの誤作動等の原因となります。
- ◎電球交換・羽の回転方向切替えが容易にできる高さ(脚立を使用して届く高さ)に設置してください。
- ◎傾斜天井への設置はできません。
- ◎取付けは必ず電気工事業者へご依頼ください。



オプションパーツ Model E20-0279 Lighting kit 装着イメージ

Option for DT18-CF08 Model DT18-CF08 Single spin canvas bladesの専用オプションです。



Lighting kit
Model E20-0279
H.130 W.270 D.270mm
¥18,000+税
使用電球: 白熱電球 MAX 40W / E26×2pcs
LED電球 MAX 8.5W / E26×2pcs
(調光器 / 密閉器具対応電球のみ)
4 997337 073134
◎電球は付属しません。



Canvas blades
交換用キャンバス羽4枚セット
Model DT18-CF/B/OW
¥4,800+税
4 997337 092616



Remote controle & Receiver set
Model E20-0280
H.100 W.50 D.15mm
¥12,000+税
4 997337 073141
◎コントローラーキット単体での販売は行っていません。
◎本体(DT18-CF08)のご注文の際にオプションパーツとして併せてご注文ください。
◎製品の仕様は予告なく変更になる場合があります。あらかじめご了承ください。



90cm down rod for DT18-CF08
Model DT03-CF/D90GY
L.900mm
¥2,600+税
4 997337 369022



60cm down rod for DT18-CF08
Model DT03-CF/D60GY
L.600mm
¥2,300+税
4 997337 366021

◎Wall lampには電球・プラグ・電気コードは付属しません。
◎取付けは必ず電気工事業者にご依頼ください。

◎室内用です。◎電球は付属しません。



Stainless table & bench

材質：201ステンレススチール、ポリエチレン



Single

Model H945-1254S

テーブル時
H.743mm W.750mm
D.1400mm

ベンチ時
H.870mm W.750mm
D.600mm

Seat height : 450mm

Weight : 約22kg

¥61,000+税

4 997337 925419



Double

Model H945-1254D

テーブル時
H.743mm W.1250mm
D.1400mm

ベンチ時
H.870mm W.1250mm
D.600mm

Seat height : 450mm

Weight : 約26kg

¥83,000+税

4 997337 925426



Aluminum cafe table square



Model H845-1024
H.720~730 W.600 D.600mm
¥23,000+税

材質：本体/アルミニウム
天板/ポリスチレン樹脂



L. Brown
Model H845-1024LBR

4 997337 802475



Black
Model H845-1024BK

4 997337 802499

Aluminum round table 60



Model F19-0002
H.720~730 φ600mm
¥20,000+税

材質：アルミニウム、アイアン



4 997337 006309

◎脚部はsatin finishになります。

Aluminum cafe chair



Model H845-1022
H.740 W.550 D.570mm
Seat height 425mm
¥11,000+税
材質：本体 / アルミニウム
座面 / フッ素樹脂加工



Black

Model H845-1023BK
H.740 W.550 D.550mm
Seat height 415mm
¥12,000+税
材質：本体 / アルミニウム
座面 / ポリスチレン樹脂



Aluminum roundish chair

H.770 W.560 D.550
Seat height 425mm
¥18,000+税

材質：本体 / アルミニウム
座面 / ポリエチレン樹脂



Green / Blue
Model F19-0001GN/BL



Red / Green
Model F19-0001RD/GN



Blue / Yellow
Model F19-0001BL/YL



Beer table

130 / Dark green
Model F21-0396S/DGN
H.750 W.1290 D.495mm
Folding H.66 W.1290 D.495mm
¥21,000+税
材質：天然木(モミ材)、スチール(粉体塗装)
ポリプロピレン



Beer bench

130 / Dark green
Model F21-0397S/DGN
H.450 W.1290 D.245mm
Folding H.57 W.1290 D.245mm
¥13,000+税
材質：天然木(モミ材)、スチール(粉体塗装)
ポリプロピレン



Beer table

180 / Dark green
Model F21-0396L/DGN
H.750 W.1790 D.495mm
Folding H.55 W.1790 D.495mm
¥24,000+税
材質：天然木(モミ材)、スチール(粉体塗装)
ポリプロピレン



Beer bench

180 / Dark green
Model F21-0397L/DGN
H.450 W.1790 D.245mm
Folding H.57 W.1790 D.245mm
¥17,500+税
材質：天然木(モミ材)、スチール(粉体塗装)
ポリプロピレン



Aluminum folding chair

材質：アルミニウム、WPC



Model Y-0444
H.774 W.555 D.606mm
Folding H.840 W.555 D.130mm
Seat height 395mm
¥26,000+税



Folding



Galvanized fence

材質：スチール



600×600
Model D19-0040/6060
D.32mm
¥6,800+税
4 997337 058964



900×900
Model D19-0040/9090
D.32mm
¥9,800+税
4 997337 058957

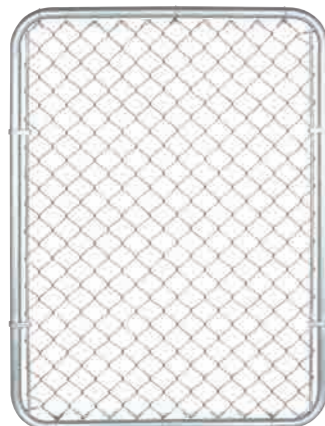

1200×900
Model D19-0040/1290
D.32mm
¥12,800+税
4 997337 085465

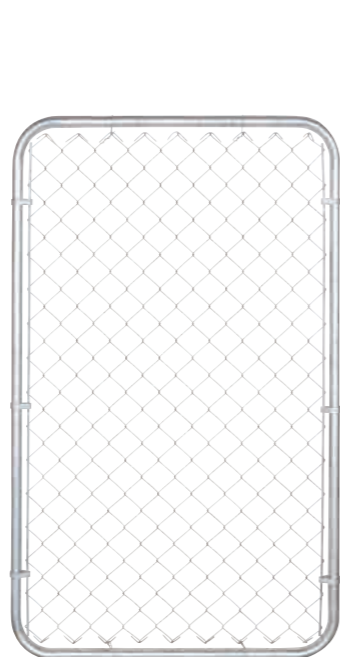

1500×900
Model D19-0040/1590
D.32mm
¥13,800+税
4 997337 058940



1800×900
Model D19-0040/1890
D.32mm
¥14,800+税
4 997337 058933



Option for D19-0040

Model D19-0040
Galvanized fenceの専用オプションです。

Galvanized base 900

Model D19-0042
H.900 W.60 D.400mm
¥3,500+税
4 997337 058988



◎フェンスを自立させる専用ベースです。

Galvanized parts 32×32

Model D19-0041
H.38 W.100 D.33mm
¥450+税
4 997337 058971



◎フェンスとベースの取り付け、フェンス同士の連結に使用する接続パーツです。
◎フェンスとベースの取り付けには4pcs必要です。
◎フェンス同士の連結には2pcs必要です。



Mini fence

材質：スチール



◎P340に掲載の Model 120-363にも連結可能です。



Model D19-0043
Fence H.309 W.200 D.9mm×2pcs
付属品 ジョイント×2set
¥4,300+税
4 997337 058995



Mini fence joint set
Model D19-0043J
Fence H.305 W.200 D.9mm×1pc
付属品 ジョイント×2set
¥2,800+税
4 997337 059008



Rubber parking curb



Model MT-0407
H.100 W.560 D.155mm
Weight 約 5.5kg
固定用穴径 φ20mm
¥7,000+税
材質：スチレン・ブタジエンゴム
4 997337 080668



TOP

◎設置用の取付け用具は付属していません。別途ご用意ください。

◎設置前に付属ステッカーを本体に貼り付けてご使用ください。



ステッカー



商品本体



Folding 2-steps ladder



Model 100-271
H.485 W.490 D.440mm
Folding 575×490×45mm



Color	Price
Galvanized	¥11,800+税
Ivory	¥10,800+税
Red	¥10,800+税
Yellow	¥10,800+税
Gray green	¥10,800+税

Folding 3-steps ladder



Model 100-252
H.685 W.490 D.680mm
Folding 830×490×45mm



Color	Price
Galvanized	¥14,800+税
Ivory	¥13,800+税
Red	¥13,800+税
Gray green	¥13,800+税



STORE FIXTURES



Doctor cabinet



S
 Model 100-150
 H.1320 W.690 D.450mm
 Glass board W.627 D.338mm

Color	Price
● H.D galvanized	¥88,000+税
● Raw	¥80,000+税
● Ivory	¥73,000+税

◎棚板：強化ガラス×3枚 ◎施錠可能



L
 Model 100-158
 H.1620 W.690 D.450mm
 Glass board W.627 D.338mm

Color	Price
● H.D galvanized	¥103,000+税
● Raw	¥94,000+税
● Ivory	¥89,000+税

◎棚板：強化ガラス×3枚 ◎施錠可能



Triangle cabinet

Model 120-358
 H.1620 W.710 D.540mm

Color	Price
● Raw	¥93,000+税
● Ivory	¥83,000+税

◎棚板：強化ガラス×3枚



4 tier tapered metal shelf

Model 116-323
 H.1180 W.850 D.400mm
 a)H.293 b)H.293 c)H.293
 d)D.250 e)D.400



Ivory
 ¥36,000+税 4 997337 632317



Raw
 ¥42,000+税 4 997337 632393



◎棚の高さ調節はできません。



①以外の棚板は可動式です。
 ②は上下のシェルフを固定する棚のため可動できません。

Steel shelf 5 layer

Model F20-0181
 H.1830 W.900 D.460mm
 ¥25,000+税
 材質：スチール（粉体塗装）



Color
 ● Dark green 4 997337 067478
 ● Ivory 4 997337 067485
 ● Moss gray 4 997337 067492
 ● Sax blue 4 997337 067508



◎棚板は可動式です。

Steel shelf 3 layer

Model F20-0180
 H.920 W.900 D.460mm
 ¥18,000+税
 材質：スチール（粉体塗装）



Color
 ● Dark green 4 997337 067430
 ● Ivory 4 997337 067447
 ● Moss gray 4 997337 067454
 ● Sax blue 4 997337 067461



◎棚板は固定式です。

Metal tool cart

Model F20-0179
 H.830 W.790 D.370mm
 Tray H.50 W.675 D.340mm
 ¥20,000+税
 材質：スチール（粉体塗装）



Color
 ● Dark green 4 997337 067393
 ● Ivory 4 997337 067409
 ● Moss gray 4 997337 067416
 ● Sax blue 4 997337 067423

Swing convertible table & shelf

Model GM-0608
 Shelf H.1390 W.1165 D.590mm
 Table H.795 W.1165 D.1500mm
 ¥127,000+税

材質：スチール（粉体塗装）
 パイン材（ウレタン塗装）

アジャスタ付き

4 997337 089890

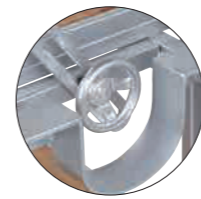

固定ハンドル



Table



Shelf

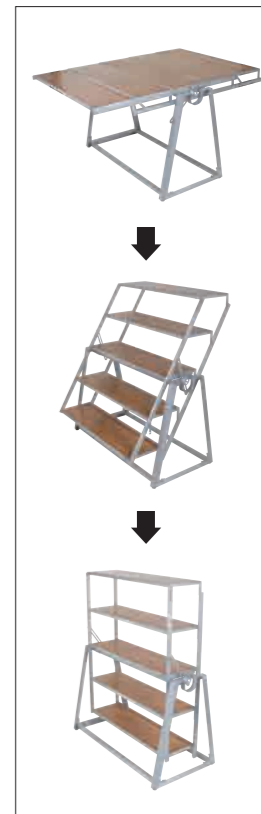

◎テーブル→階段シェルフ→直立シェルフに変形可能。
 ◎階段シェルフはサイドのハンドルを緩めて好きな角度で固定できます。



Book shelf

Model XP-055XS
H.1950 W.1300 D.490mm
¥158,000+税

材質：リサイクルウッド、アイアン

4 997337 465526



◎古材を使用しているため
木目や色味に個体差があります。



Galvanized shelf



Double 900
Model SLF01-900D
H.900 W.1710 D.425mm
¥82,000+税

4 997337 075459



Double 1430
Model SLF01-1430D
H.1430 W.1710 D.425mm
¥95,000+税

4 997337 075466



Single
Model SLF01-S
H.1930 W.1200 D.425mm
¥110,000+税

4 997337 987011

4cartons for one set



Double
Model SLF01-D
H.1930 W.1710 D.425mm
¥130,000+税

4 997337 987028

5cartons for one set





Organic
Crushed
Tomatoes
No Salt Added
Dulton
Temporary Price Reduction
\$60.02

STORE HOURS
MON. 8:00 to 5:00
TUE. 8:00 to 5:00
WED. 8:00 to 5:00
THU. 8:00 to 5:00
FRI. 8:00 to 5:00
SAT. 8:00 to 9:00
SUN. closed to 12:00

DULTON
Our products are designed
based on our ideas for
personal pleasure.
**THANK YOU FOR
YOUR PATRONAGE!**

Wire shelf
Model MT-0526
H.1500 W.700 D.300mm



Galvanized
¥23,000+税 4 997337 086240



Sand beige
¥20,000+税 4 997337 086233

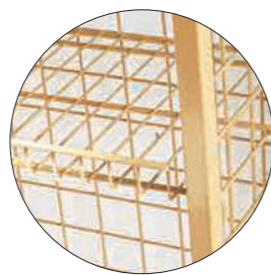

©MT-525はカゴが取り外し可能です。

Wire round rack Model MT-0525
H.1320 W.440 D.425mm



Galvanized
¥28,000+税 4 997337 086226



Sand beige
¥25,000+税 4 997337 086219

Wire rack Model MT-0524
H.1275 W.455 D.395mm



Galvanized
¥19,000+税 4 997337 086202



Sand beige
¥17,000+税 4 997337 086196

KITCHENWARE

SMALL SUNDRIES

Pegboard display rack

Model F21-0333
H.1575 W.946 D.405mm
¥80,000+税

材質：合板、アルミニウム

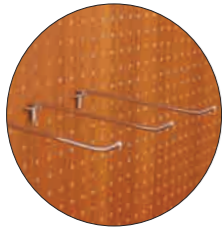

〔Hook 18pcs 付属〕
・10cm hook...6pcs
・15cm hook...6pcs
・20cm hook...6pcs

Stainless work bench

Model Y-0447
H.955 W.1250 D.455mm
Table top H.870mm
Drawer H.80 W.820 D.360mm
Hole 5mm Pitch 25mm
¥115,000+税

材質：201ステンレススチール
2cartons for one set



エンボスロゴ



Stainless sink

水栓穴：φ35mm (1箇所)
排水穴：φ43.8mm

材質：ステンレススチール(SUS304)
パイブレーション仕上げ

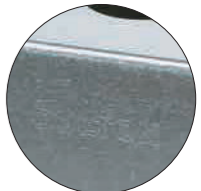

刻印ロゴ



Square

Model H22-0402SQ
H.135 W.490 D.470mm
¥75,000+税



Rectangle

Model H22-0402RC
H.135 W.900 D.450mm
¥83,000+税



◎上水・排水管を接続する工事は、専門業者に依頼ください。
◎水栓(蛇口)や取り付け金具は付属していません。
◎水栓(φ35mm)/排水穴(φ43.8mm)は一般的なサイズのため、市販の蛇口や取り付け金具をご使用いただけます。海外製の蛇口や金具は合わない場合もありますので必ず事前にサイズをご確認ください。
◎パイブレーション仕上げ加工はハンドメイドのため、研磨跡に個体差があります。素地が見えている場合もありますが、使用上問題ありません。

HOUSEWARE

GARDEN & GREEN

KITCHENWARE

SMALL SUNDRIES



Store wagon

Model MT-0531
 H.1673 W.740 D.1645mm
 Top board W.740 D.1265mm
 Weight 52kg
 ¥115,000+税
 材質：スチール、ポリプロピレン

4 997337 086523



ロゴプレート

◎TOPスライド式収納。耐荷重3kg



H.130 φ210mm

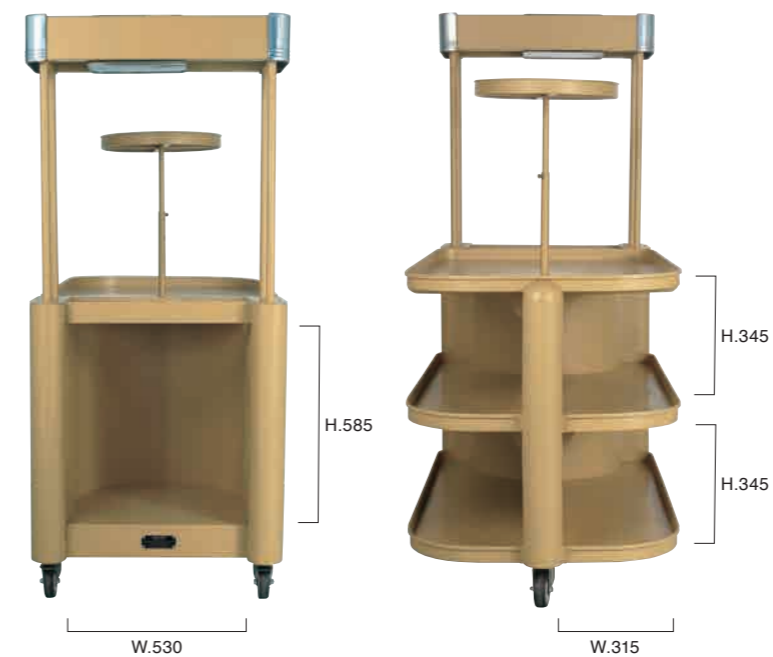
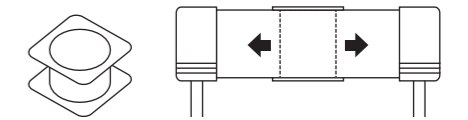

◎バーとトレイの2種類を用途に合わせて入れ替え可能。耐荷重5kg

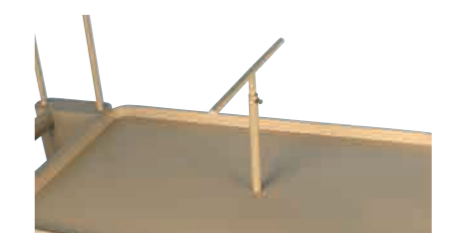

H.330~830 W.498mm



H.330~650 φ430mm



Dining table   
材質：リサイクルウッド

Dining table S
Model XP-001S
H.740 W.1380 D.780mm
¥95,000+税

4  997337246118

Dining table M
Model XP-001M
H.740 W.1800 D.900mm
¥158,000+税

2  000000055435

Dining table
Model XP-001
H.800 W.2400 D.1000mm
¥180,000+税

4  997337246019



©画像はModel XP-001



◎古材を使用しているため
木目や色味に個体差があります。

Round table   
材質：リサイクルウッド



Model XP-020
H.800 φ1500mm
¥230,000+税
4  997337246200



Round coffee table **CT**

材質：本体/リサイクルウッド
底面/ファブリック



S
Model **GM-0473S**
H.457 φ920mm
¥143,000+税



©古材を使用しているため木目や色味に個体差があります。



L
Model **GM-0473L**
H.457 φ1225mm
¥165,000+税



Steel frame mirror with pegboard

Model **GM-0660**
H.1800 W.1300 D.270mm
¥60,000+税

材質：スチール、ガラス、MDF、メラミン化粧板

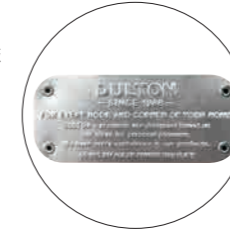

ロゴプレート



©P128 掲載の Model D19-0040/1890 Galvanized fence 1800×900を
D19-0041 Galvanized parts 32×32を使用して連結することも可能です。



©製造工程上、パイプ部やフレーム部の表面にスレや汚れのような跡がみられます。
製品の特性としてご理解ください。



Galvanized frame stand

⇒このシリーズのその他の製品は P219に掲載されています。

材質：スチール、MDF、アクリル



A1
Model RN-0400-A1
H.905 W.655 D.20mm
¥19,000+税

4 997337 080514



A0
Model RN-0400-A0
H.1245 W.905 D.20mm
¥36,000+税

4 997337 080507



DULTON Sign stand

材質：Silver / スチール (粉体塗装)
Raw / スチール (ラッカー塗装)



A5
H.750 W.200 D.200mm
¥9,000+税



Silver
Model RNZ-0457-A5SV

4 997337 083478

Raw
Model RNZ-0457-A5RW

4 997337 083482

A4
H.940 W.250 D.250mm
¥11,000+税



Silver
Model RNZ-0457-A4SV

4 997337 083485

Raw
Model RNZ-0457-A4RW

4 997337 083508



Stainless collection case

Model AS-0551
H.75 φ400mm
¥17,500+税

材質：ステンレススチール(SUS202)
ガラス、シリコンゴム

4 997337 087247



ベース背面 レーザーロゴ



◎ハンドメイドのため、大きさ・重量などに個体差があります。
◎ガラスカバーは製品工程上、若干の歪み、シワ・気泡等が生じる場合があります。
製品の特性としてご理解ください。



DULTON Tray stand

High) H.840 φ220mm
Low) H.540 φ220mm
¥11,000+税
材質：スチール(粉体塗装)、セメント

Silver
Model RNZ-0624SV
4 997337 090469

Raw
Model RNZ-0624RW
4 997337 090476



◎2サイズのボールが付属しております。用途に合わせて付け替えてご使用ください。
◎安全のため、トレイに載せるものは1kg以下にしてください。

Open-closed sign stand

Model 123-385
H.1100 W.569 D.290mm
¥16,800+税
材質：スチール(クロムメッキ)、アルミニウム

4 997337 092951

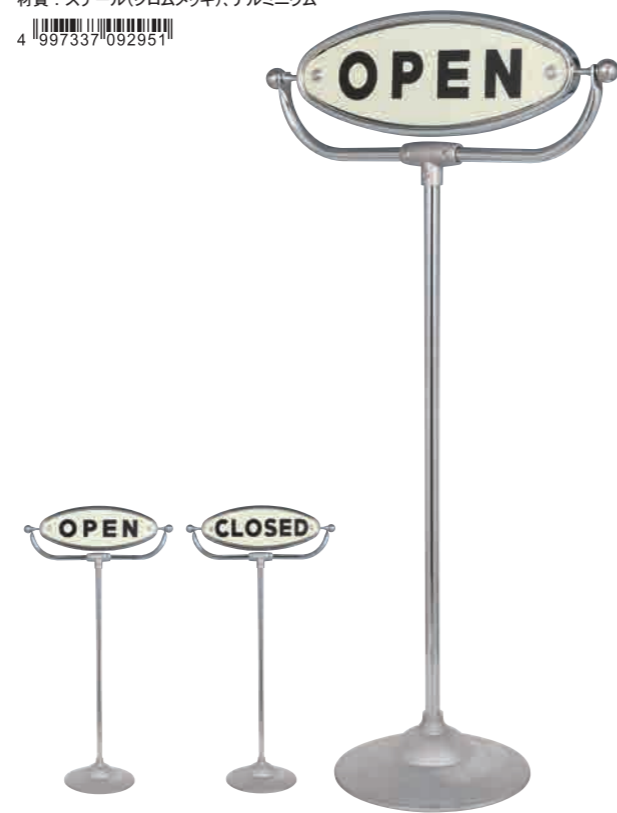

◎看板部分を回転させる事でOPEN⇄CLOSEDが切り替わります。
◎強風時は転倒等の恐れがありますのでご使用をお控えいただくか、「重し」等でしっかりと固定してご使用ください。◎雨天時の屋外でのご使用はお止めください。

Spinner sign stand open-closed
H.985 W.1240 D.235mm
¥8,500+税

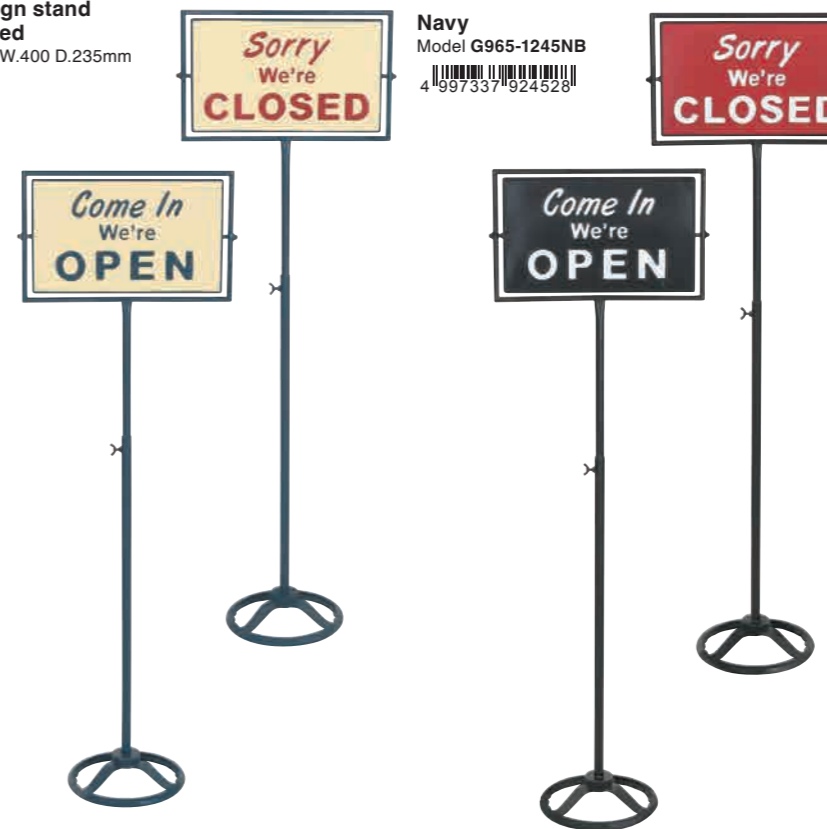

◎看板部分を回転させる事でOPEN⇄CLOSEDが切り替わります。
◎強風時は転倒等の恐れがありますのでご使用をお控えいただくか、「重し」等でしっかりと固定してご使用ください。
◎雨天時の屋外でのご使用はお止めください。

Navy
Model G965-1245NB
4 997337 924528

Black
Model G965-1245BK
4 997337 924511

Wall mount spinner sign open-closed

H.610 W.200 D.105mm
¥6,500+税
取付ネジ付属 4pcs



◎看板部分を回転させる事でOPEN⇄CLOSEDが切り替わります。

Black
Model G965-1246BK
4 997337 924610

Navy
Model G965-1246NB
4 997337 924627



Open-closed sign stand

Model S355-83
H.1060 W.570 D.235mm
¥13,500+税

4 997337 355834



◎強風時は転倒等の恐れがありますのでご使用をお控えいただくか、「重し」等でしっかりと固定してご使用ください。
◎雨天時の屋外でのご使用はお止めください。



Folding sign board stand

Model S355-39
H.1035 W.500 D.395mm
Board H.820 W.415mm
Folding H.1150 W.500mm
¥13,000+税

4 997337 447126



◎チョークやマグネットが使用できます。
◎片面のみ書き込み可能。
◎強風時は転倒等の恐れがありますのでご使用をお控えいただくか、「重し」等でしっかりと固定してご使用ください。
◎雨天時の屋外でのご使用はお止めください。



◎こちらのページに掲載されている製品は、アンティークの雰囲気を出すための仕上げ(色ムラ・塗装はがれ等)が施されています。
◎塗装の風合いに多少の個体差があります。
◎設置面に「サビ」が色移りする場合があります。製品の特性としてご理解ください。

The DULPEDIA 2024

HOUSEWARE

Storage 156

Cleaning 174

Sanitary 192

Houseware 200

Hardware 208

Decoration 218

Fabric 232

PROPRIÉTÉ PRIVÉE
DÉFENSE D'ENTRER





Mini parts box
Model CH15-H529
H.75 W.100 D.160mm



Color	Price
Galvanized	4 997337 505291
Raw	4 997337 535298
Ivory	4 997337 515290
Red	¥1,200+税 4 997337 525299
Yellow	4 997337 063234
Olive Drab	4 997337 565295
Navy	4 997337 063241

Parts stocker
Model CH07-H298
H.130 W.170 D.280mm

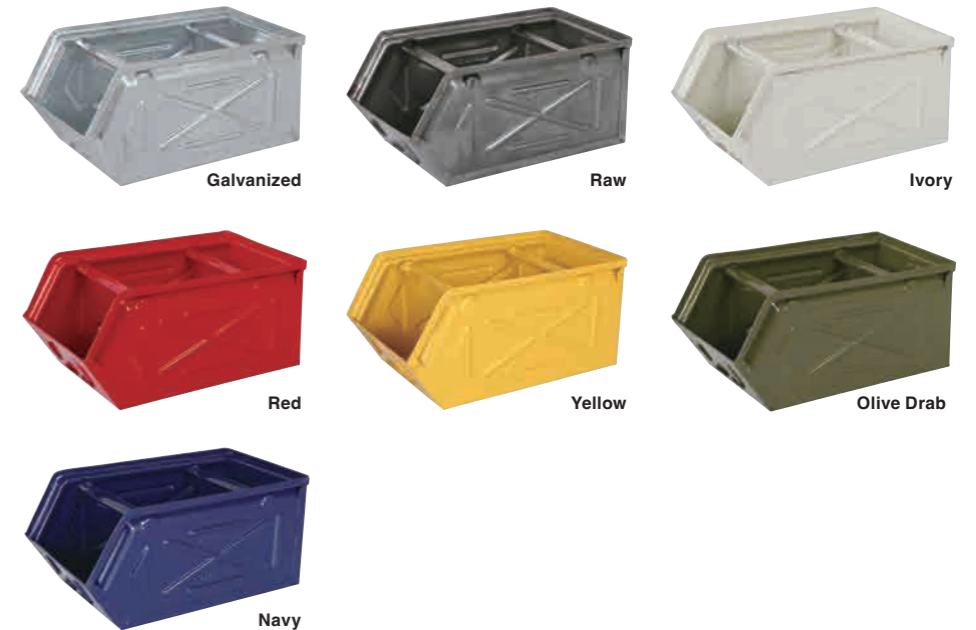

Color	Price
Galvanized	4 997337 729802
Raw	¥3,200+税 4 997337 729857
Ivory	4 997337 729819
Red	4 997337 729826
Yellow	¥2,600+税 4 997337 063258
Olive Drab	4 997337 729871
Navy	4 997337 063265

D.M.S "Garage" 6L

Model 117-327
H.120 W.200 D.315mm
Inside H.105 W.175 D.285mm



Color	Price	Barcode
Galvanized	¥4,500+税	4 997337 732796
Raw		4 997337 732789
Ivory	¥3,600+税	4 997337 732710
Red		4 997337 732727
Yellow		4 997337 732734
Olive Drab		4 997337 732741



D.M.S "Garage" 16L

Model 113-298
H.185 W.300 D.400mm
Inside H.175 W.280 D.390mm



Color	Price	Barcode
Galvanized	¥8,000+税	4 997337 329804
Ivory		4 997337 329811
Red	¥6,800+税	4 997337 329828
Olive Drab		4 997337 329866



© Model 113-298と
Model 117-327は
スタッキングが可能です。



Aluminum container "CONVOY 2" RL

材質：アルミニウム、スチール



◎同サイズ3つまでスタッキングが可能です。

◎H21-0352 Aluminum container "CONVOY 2"の後継品です。
H21-0352とは製品サイズが異なります。
H21-0352とはスタッキングできかねますのでご了承ください。



S

Model H23-0667S
H.235 W.550 D.295mm
¥16,000+税



M

Model H23-0667M
H.285 W.640 D.360mm
¥20,000+税



L

Model H23-0667L
H.345 W.780 D.425mm
¥27,000+税



XL

Model H23-0667XL
H.395 W.900 D.495mm
¥38,000+税



Galley delivery box



Model H21-0351
H.550 W.290 D.410mm
Inside H.430 W.255 D.365mm
¥47,600+税

材質：アルミニウム、304ステンレススチール



◎付属品
盗難防止用ワイヤー φ5mm / 2m
南京錠 2pcs (ワイヤー施設用 / 扉施設用)
宅配業者向けステッカー 1pc



いつも配達ありがとうございます
① ボックス内の印籠で受取伝票に押印してください。
② 印籠と受取伝票をボックス内に入れてください。
③ 扉を閉め場合に南京錠をかけてください。
※ボックスに入らない場合、お手数ですが再配達をお願いいたします





DULTON Folding container

材質：ポリプロピレン
蓋ロック機能付

◎40Lの上に20Lを2つ並べてスタッキング可能。

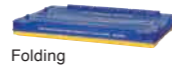

Folding

20L

Model H21-0343-20
H.283 W.366 D.264mm
Inside H.258 W.335 D.231mm
Folding H.81 W.366 D.264mm
¥4,800+税

4 997337 077132



40L

Model H21-0343-40
H.283 W.530 D.366mm
Inside H.258 W.493 D.335mm
Folding H.67 W.530 D.366mm
¥6,000+税

4 997337 077149



Basket trolley

Model S359-49
H.450~920 W.470 D.365mm
¥3,600+税

材質：ポリプロピレン、アルミニウム



Red 4 997337 594929



Blue 4 997337 594950

Wooden box

Model 100-226

材質：本体/バーチ材(外側)
コットンウッド材(内側)
フレーム/スチール



◎同サイズでスタッキングが可能です。

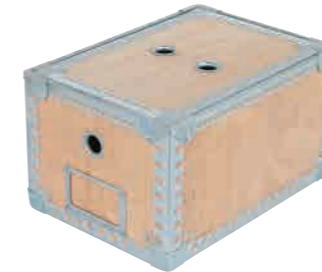

S

H.210 W.345 D.255mm
Inside H.190 W.330 D.235mm
¥5,500+税

4 997337 122610



M

H.240 W.400 D.315mm
Inside H.220 W.380 D.290mm
¥6,500+税

4 997337 122627

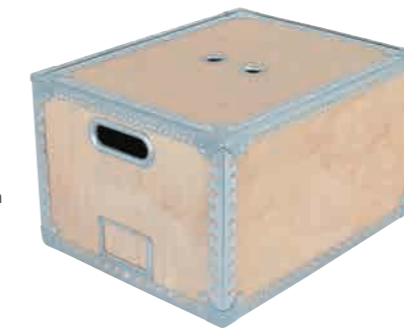

L

H.275 W.450 D.360mm
Inside H.255 W.430 D.345mm
¥8,000+税

4 997337 122634



Wooden cabinet with layer

Model 121-372
H.350 W.305 D.395mm
Inside H.160 W.295 D.380mm (x2)
¥9,000+税



4 997337 076470

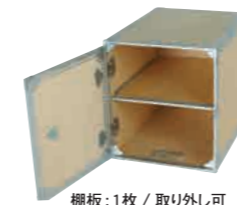

棚板：1枚 / 取り外し可
(高さ調節はできません)



棚板：4枚
棚板間隔：135mm
(高さ調節はできません)

◎工具は付属しません。
ドライバーをご用意ください。

◎こちらのページに掲載されているウッド製品は、天然の素材を使用しておりますので木目や色に個体差が生じます。製品の特性としてご理解ください。
◎製造工程上、バリなどの鋭利な箇所があります。
指や手を切ったり衣類を引っ掛けたりしないよう取り扱いにはご注意ください。
◎防水、防錆加工は施してありません。材質の性質上、経年劣化でサビが発生する場合があります。

Wooden cabinet w/casters 4 layers

Model 113-296-4L
H.805 W.330 D.460mm
Board(x4) 305x415mm
¥27,000+税



材質：本体/バーチ材(外側)
コットンウッド材(内側)
フレーム/スチール

4 997337 329644





Wire rack w/ castors PK 70
材質：スチール

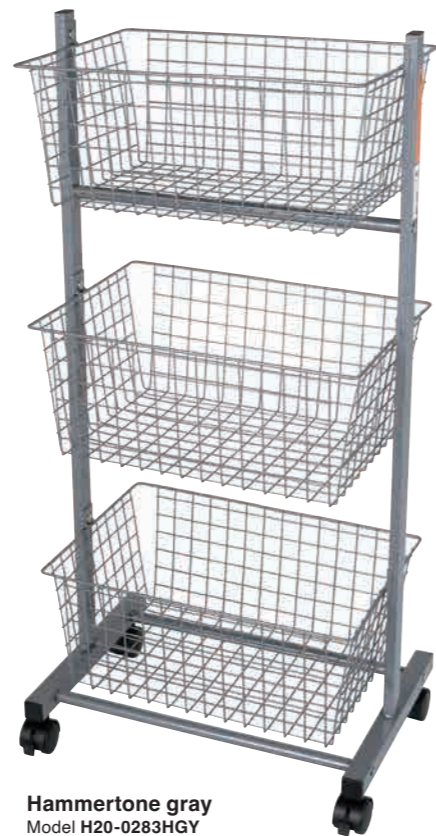

Hammertone gray
Model H20-0283HGY
H.900 W.445 D.310mm
バスケット内寸 H.160 W.335 D.225mm
¥12,000+税
4 997337 073363

Slanting wire rack PK 70
材質：スチール

S
H.740 W.260 D.315mm
バスケット内寸 H.110 W.180 D.120mm
¥8,000+税



Hammertone gray
Model H20-0282S/HGY
4 997337 073325

M
H.745 W.315 D.360mm
バスケット内寸 H.105 W.235 D.175mm
¥9,000+税

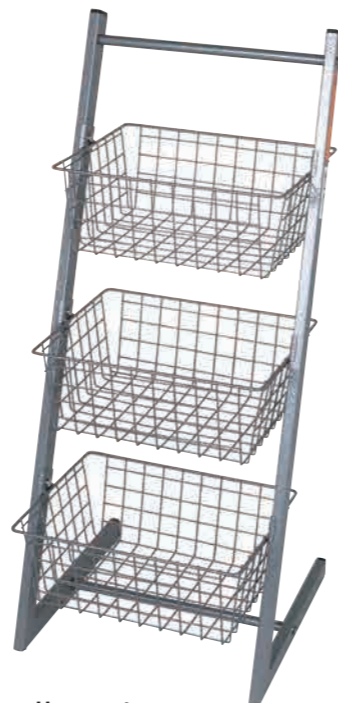

Hammertone gray
Model H20-0282M/HGY
4 997337 073349

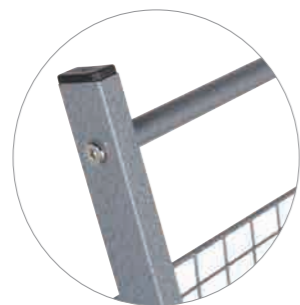

Hammertone gray



Magazine rack iron YEN
Model K955-1211
H.392 W.375 D.175mm
¥6,200+税
4 997337 912112



Magazine rack fir wood YEN
Model K955-1212
H.270 W.400 D.280mm
Folding H.380 D.90mm
Basket H.190 W.310 D.206mm
¥7,500+税
4 997337 912129



Wire magazine rack PK 70 YEN
Model S255-58
H.1235 W.345 D.280mm
Rack H.330 D.130mm / each
¥22,000+税
4 997337 255585

◎アンティークの雰囲気を出す為の仕上げ(色ムラ・塗装はがれ等)が施されています。
◎塗装や仕上げの風合いに多少の個体差があります。製品の特性としてご理解ください。
◎設置面に「サビ」が色移りする場合があります。設置箇所にはご注意ください。

Market basket S
Model CH99-W04S
H.160 W.350 D.245mm
¥2,300+税

材質：本体/スチール
ハンドル/ポリプロピレン

Wire color	Parts color
● Chrome	● Red
● Chrome	● Yellow
● Chrome	● Blue

Market basket L
Model CH99-W04
H.200 W.450 D.315mm
¥2,500+税

材質：本体/スチール
ハンドル/ポリプロピレン

Wire color	Parts color
● Chrome	● Red
● Chrome	● Yellow
● Chrome	● Blue



Wooden stacking box A
Model CH14-H518NT
H.110 W.260 D.360mm
Inside H.90 W.240 D.320mm
¥3,400+税



Wooden stacking box B
Model CH14-H519NT
H.140 W.220 D.330mm
Inside H.120 W.200 D.290mm
¥3,300+税



Wooden box
Model CH10-H410NT
H.74 W.120 D.250mm
Inside H.59 W.100 D.230mm
¥1,400+税



3 partition wooden box
Model CH11-H415NT
H.100 W.100 D.250mm
Inside H.90 W.80 D.70mm /each
¥1,900+税



6 partition wooden box
Model CH11-H417NT
H.40 W.170 D.250mm
Inside H.30 W.70 D.70mm /each
¥1,600+税



8 partition wooden box
Model CH11-H418NT
H.40 W.170 D.325mm
Inside H.30 W.70 D.70mm /each
¥1,900+税



Wooden stocker box
Model CH14-H500NT
H.85 W.170 D.250mm
Inside H.80 W.150 D.230mm
¥2,000+税



Wooden organizer box
Model CH14-H501NT
H.47 W.180 D.240mm
Inside A) H.40 W.95 D.50mm /each
Inside B) H.40 W.60 D.50mm
Inside C) H.40 W.60 D.165mm



Wooden box for postcards
Model CH14-H502NT
H.53 W.170 D.200mm
Inside H.50 W.155 D.40mm /each
¥2,000+税



Wooden box for business cards
Model CH14-H503NT
H.43 W.110 D.200mm
Inside H.35 W.95 D.35mm /each
¥1,400+税



12 partition wooden box "H65"
Model CH14-H520NT
H.65 W.275 D.365mm
Inside H.55 W.80 D.80mm /each
¥2,900+税



6 partition wooden box "H65"
Model CH14-H521NT
H.65 W.170 D.245mm
Inside H.55 W.70 D.70mm /each
¥1,900+税



Wooden organizer box
Model CH14-H522NT
H.70 W.175 D.320mm
Inside A) H.60 W.72 D.72mm /each
Inside B) H.60 W.155 D.72mm /each
¥2,400+税



材質：天然木
◎アンティークの風合いを出す為の加工（本体表面のキズ、塗装や印刷の擦れ）等を施しております。
◎天然の素材を使用しておりますので木目や色に個体差が生じます。製品の特性としてご理解ください。



WAX CANVAS LOG BAG

Wax canvas log bag

H.320 W.600 D.250mm
Handle L.470mm
¥3,800+税

材質：コットン100% (ワックス加工)、真鍮



Camel
Model Y959-1267CAM
4 997337 926737



Olive
Model Y959-1267OV
4 997337 926744

Wax canvas multipurpose tool bag

H.260 W.360mm
Strap L.950mm
¥3,400+税

材質：コットン100% (ワックス加工)、真鍮



Camel
Model Y959-1266CAM
4 997337 926614



Olive
Model Y959-1266OV
4 997337 926621



Wax canvas lunch bag

H.380 W.240 D.140mm
¥2,600+税

材質：コットン100% (ワックス加工)
アルミ蒸着フィルム、牛革、真鍮



Camel
Model Y959-1265CAM
4 997337 926515



Olive
Model Y959-1265OV
4 997337 926522



◎こちらのページに掲載されている製品はハンドメイドのため、生産毎に色の濃淡や、材質の風合いに多少の個体差があります。
◎染色の際に生地が縮み、多少サイズに個体差があります。多少のムラ・糸のほつれ・糸飛び等があります。製品の特性としてご理解ください。
◎インド綿特有のニオイが気になる場合は、風通しの良い場所で陰干しすることにより解消されます。洗濯の際は、他の物とお分けください。
◎ワックス加工を施している製品は表面にヒビ割れ、シワ(チョークマーク)が生じる場合があります。製品の特性としてご理解ください。

1 Mile tote bag

H.180 W.290 D.125mm
¥2,000+税

材質：コットン100%、真鍮



Natural
Model H20-0284NT
4 997337 073400



Charcoal gray
Model H20-0284CGY
4 997337 073417



Camel
Model H20-0284CAM
4 997337 073424



Wax canvas tool bag

H.240 W.350 D.200mm
¥4,000+税

材質：コットン100% (ワックス加工)、真鍮



Olive
Model T21-0337OV
4 997337 077019



Camel
Model T21-0337CAM
4 997337 077002

◎こちらのページに掲載されている製品はハンドメイドのため、生産毎に色の濃淡や、材質の風合いに多少の個体差があります。
◎染色の際に生地が縮み、多少サイズに個体差があります。多少のムラ・糸のほつれ・糸飛び等があります。製品の特性としてご理解ください。
◎インド綿特有のニオイが気になる場合は、風通しの良い場所で陰干しすることにより解消されます。
◎ワックス加工を施している製品は表面にヒビ割れ、シワ(チョークマーク)が生じる場合があります。製品の特性としてご理解ください。



Worker bag
H.280 W.350 D.200mm
¥3,700+税
材質：コットン100% (ワックス加工)、真鍮



Natural
Model H20-0285NT
4 997337 073592



Olive
Model H20-0285OV
4 997337 073608



Camel
Model H20-0285CAM
4 997337 073615

Wax canvas field cloth

材質：コットン100% (ワックス加工)、真鍮

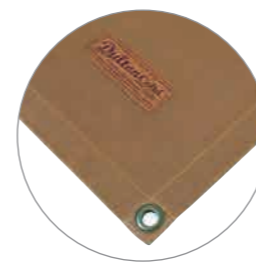

S / Camel G20-0274S/CAM 680×1000mm ¥2,300+税 4 997337 072908

L / Camel G20-0274L/CAM 1000×1400mm ¥3,600+税 4 997337 072922

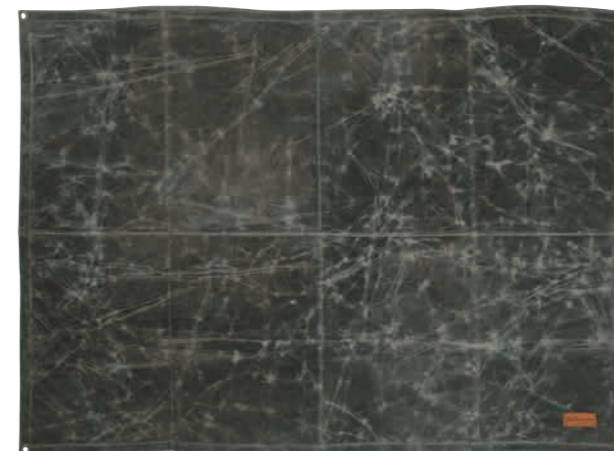
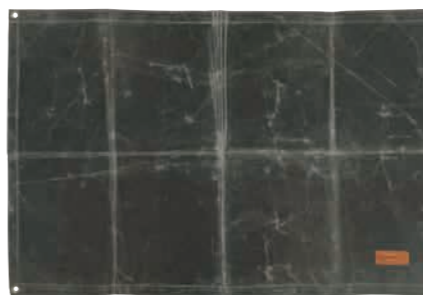

S / Olive G20-0274S/OV 680×1000mm ¥2,300+税 4 997337 072892

L / Olive G20-0274L/OV 1000×1400mm ¥3,600+税 4 997337 072915

◎両面にパラフィン加工が施されており、パラフィン加工の特性として、表面にヒビや割れシワ(チョークマーク)があります。ハンドメイドのため、生産毎にサイズや風合い、色の濃淡やチョークマークのつき方に大きく個体差があります。製品の特性としてご理解ください。
◎チョークマークはパラフィン加工独特の味わいの一つですが、アイロンを当てて目立たなくさせることができます。アイロンをかける場合は必ず当て布をしてください。





Flower bag

H.500 W.290 D.30mm
¥2,300+税

材質：コットン100% (ワックス加工)、PVC、ジンクアロイ



Natural
Model H20-0299NT
4 997337 074315



Camel
Model H20-0299CAM
4 997337 074322



二つ折りにし、ショルダーストラップで2つのDカンを留めれば短いブーケや植木鉢も持ち運びやすいサイズになります。



Wax canvas tool pouch

材質：コットン100% (ワックス加工)、真鍮

S
H.155 W.250mm
¥1,000+税



Olive
Model T21-0338S/OV
4 997337 077033



Camel
Model T21-0338S/CAM
4 997337 077026



L
H.235 W.340mm
¥1,400+税



Olive
Model T21-0338L/OV
4 997337 077057



Camel
Model T21-0338L/CAM
4 997337 077040



◎こちらのページに掲載されている製品はハンドメイドのため、生産毎に色の濃淡や、材質の風合いに多少の個体差があります。
◎染色の際に生地が縮み、多少サイズに個体差があります。◎多少のムラ・糸のほつれ・糸飛び等があります。製品の特性としてご理解ください。
◎インド綿特有のニオイが気になる場合は、風通しの良い場所で陰干しすることにより解消されます。
◎ワックス加工を施している製品は表面にヒビ割れ、シワ(チョークマーク)が生じる場合があります。製品の特性としてご理解ください。



Emergency bag

H.450 W.300 D.160mm
¥6,200+税

材質：600デニールナイロン (内側PVC加工)
スチール、ポリプロピレン



Black
Model H21-0381BK
4 997337 079488



Dark green
Model H21-0381DGN
4 997337 079471

Emergency pouch

H.135 W.202 D.80mm
¥2,000+税

材質：600デニールナイロン (内側PVC加工)
スチール、ポリプロピレン
付属品 ショルダーベルト



Black
Model H21-0382BK
4 997337 079501



Dark green
Model H21-0382DGN
4 997337 079495

◎背面にベルクロ付属。EMERGENCY BAG (別売)の内部に2つまでセットできます。

GARDEN & GREEN

KITCHENWARE

SMALL SUNDRIES



PLASTIC TRASH CAN



Red Yellow Blue Green Gray



カラースワッチをご用意しております。
詳しくは担当者までお問い合わせください。

18L 45L 65L 120L 240L

Model 100-195 H.400 W.290 D.320mm ¥4,500+税 水抜き穴あり
 Model 100-146 H.575 W.380 D.430mm ¥8,600+税 水抜き穴あり
 Model 100-198 H.680 W.415 D.460mm ¥10,800+税 水抜き穴あり
 Model PT120 H.940 W.465 D.560mm ¥15,000+税
 Model PT240 H.1010 W.600 D.750mm ¥23,000+税

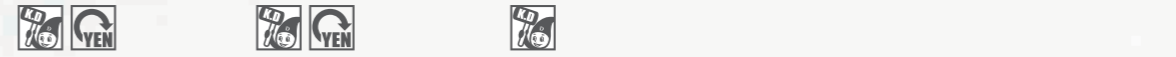

Color	18L	45L	65L	120L	240L
● Red	4 997337 119528	4 997337 014625	4 997337 119825	4 997337 612029	
● Yellow	4 997337 119535	4 997337 014632	4 997337 119832		
● Blue	4 997337 119559	4 997337 014656	4 997337 119849		
● Green	4 997337 119566	4 997337 014663	4 997337 119863	4 997337 612067	4 997337 024068
● Gray	4 997337 119504	4 997337 114608	4 997337 119801	4 997337 612098	4 997337 024099

◎製造の工程上、黒点・シワ等が生じる場合があります。製品の特性としてご理解ください。
 フタ留めピン、ホイール等のパーツの仕様が生産毎で異なる場合があります。本製品のフタにはロックは付いておりません。
 ◎屋外でも使用可能ですが風の強い日は屋内に移動させる等の措置をしてください。直射日光が当たる場所で長期間使用しますと変色、劣化等の原因となります。

材質：ポリエチレン 耐熱温度60度 耐冷温度-20度



Baby smilly
Model 100-173
L.210 W.140mm
¥1,700+税

Son of smilly
Model 100-168
L.310 W.220mm
¥2,200+税



Color	
Ivory	4 997337 117319
Red	4 997337 117326
Yellow	4 997337 117333
Sax	4 997337 117340

Color	
Ivory	4 997337 111683
Red	4 997337 221689
Yellow	4 997337 331685
Sax	4 997337 441681

Reference
Desktop, Pet Toilet, Kids Room

Reference
Floor, Toilet, Car

Smilly set long handle
Model 100-156
L.990 W.325mm
¥5,200+税



Body color	Handle color	Barcode
Ivory	Red	4 997337 156127
Red	Red	4 997337 156226
D.green	Red	4 997337 156622
Brown	Ivory	4 997337 156516
Sax	Ivory	4 997337 156417

Reference
Porch, Garden, Garage



Micro garbage can
Model 100-244
H.110 φ90mm
Inside φ80mm
¥800+税



Color	
Ivory	4 997337 124416
Red	4 997337 124423
Yellow	4 997337 124430
Galvanized	4 997337 244091

Baby garbage can
Model 100-196
H.155 φ120mm
Inside φ110mm
¥1,500+税



Color	
Ivory	4 997337 119610
Red	4 997337 119627
Yellow	4 997337 119634
Sax	4 997337 119641

Garbage can S
Model 100-106S
H.355 φ270mm 12L
¥4,700+税



Color	
Ivory	4 997337 106115
Red	4 997337 106214
Yellow	4 997337 106313
Blue	4 997337 106511

Garbage can L
Model 100-106L
H.440 φ330mm 24L
¥7,000+税



Color	
Ivory	4 997337 106139
Red	4 997337 106238
Yellow	4 997337 106337
Blue	4 997337 106535

Mini garbage can S
Model 100-105S
H.240 φ185mm 3.5L
¥2,500+税



Color	
Ivory	4 997337 516112
Red	4 997337 516211
Yellow	4 997337 516310
Blue	4 997337 516518

Mini garbage can M
Model 100-105M
H.290 φ215mm 6L
¥3,000+税



Color	
Ivory	4 997337 516129
Red	4 997337 516228
Yellow	4 997337 516327
Blue	4 997337 516525



Dust bin 



© Inner bucket
全てのサイズに付属します。

25L
Model K555-425-25
H.615 φ255mm
¥10,000+税

30L
Model K555-425-30
H.670 φ300mm
¥12,800+税

40L
Model K555-425-40
H.755 φ350mm
¥16,800+税

P100掲載



**Trash can
"Doubledecker"**
Model 100-133
H.890 W.400 D.290mm
Inner bucket 15.8L / each

Compartment bin 



2-compartment bin 18_20
Model K855-1202
H.875 W.310 D.310mm
上段 18L 下段 20L
¥20,000+税

2-compartment bin 30
Model K855-1203-2
H.480 W.410 D.360mm
15L / each
¥18,000+税



3-compartment bin 54
Model K855-1203-3
H.560 W.610 D.355mm
18L / each
¥26,000+税





2-compartment bin 60
Model K855-1204
H.655 W.585 D.360mm
30L / each
¥27,000+税



Sliding dust box 

H.273 φ195mm 6L
¥1,300+税
材質：ポリプロピレン



Olive
Model K955-1273OV

Slate
Model K955-1273SL

Italian open waste basket   

材質：ポリプロピレン
耐熱温度 120℃
耐冷温度 -20℃

Made in Italy

14L
H.320 φ300mm
¥800+税



Black
Model RN-0420-BKW

Beige
Model RN-0420-BEW



Brown
Model RN-0420-BRW



Light gray
Model RN-0420-GYW





Windproof clip ashtray
 Model 100-110
 H.150 W.75mm
 ¥1,500+税



Color
 ● Ivory 4 997337 411011
 ● Red 4 997337 411028
 ● Yellow 4 997337 411035
 ● Blue 4 997337 411059
 ● Black 4 997337 411066

Art ashtray
 H.25 W.103 D.130mm
 ¥700+税
 材質：ポーセリン



Type-E
 Model G555-539ES
 4 997337 539111



Type-K
 Model G555-539KS
 4 997337 539180



Type-L
 Model G555-539LS
 4 997337 086004



Type-M
 Model G555-539MS
 4 997337 086011



Type-N
 Model G555-539NS
 4 997337 086028



Type-P
 Model G555-539PS
 4 997337 086035



Type-Q
 Model G555-539QS
 4 997337 086042



Type-R
 Model G555-539RS
 4 997337 086059



Type-S
 Model G555-539SS
 4 997337 086066

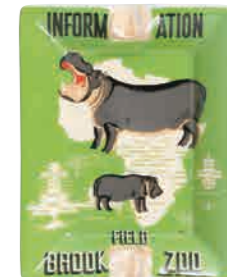

Type-T
 Model G555-539TS
 4 997337 086073

Portable ashtray



Emergencia
 Model K655-757EM
 H.16 W.50 D.50mm
 ¥800+税
 4 997337 575737



Package



Wapiti
 Model K655-757WP
 H.21 W.60 D.44mm
 ¥1,000+税
 4 997337 575720



Package



Indian
 Model K655-757ND
 H.20 W.70 D.70mm
 ¥1,200+税
 4 997337 575713



Package

Iron ashtray
 Model R855-993
 H.35 85×85mm
 ¥900+税



Antique black
 4 997337 899314

Antique Silver
 4 997337 899321

Cement organizer ashtray
 H.30 φ100mm
 ¥500+税
 LOT 6pcs

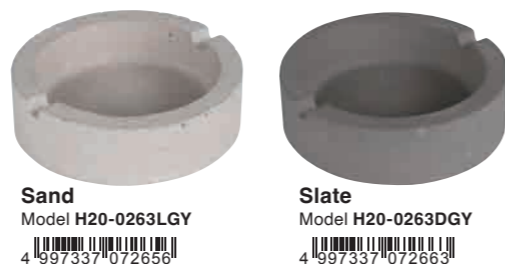

Sand
 Model H20-0263LGY
 4 997337 072656

Slate
 Model H20-0263DGY
 4 997337 072663

◎ハンドメイドのため、形・サイズ・風合いや色等に個体差があります。
 歪みや表面のキズ、ピンホール、ヒビ等が見られる場合もあります。製品の特性としてご理解ください。
 ◎セメントに水がしみ込み、設置箇所が濡れる恐れがあります。設置場所にはご注意ください。

Dustpan & brush
 Model H21-0365
 H.39 W.146 D.149mm
 ¥2,500+税
 材質：PET、アカシアウッド、マグネット
 Vibration / ステンレススチール
 Color / スチール(粉体塗装)



Vibration
 Model H21-0365VB 4 997337 078726



Ivory
 Model H21-0365IV 4 997337 078733



Red
 Model H21-0365RD 4 997337 078740

◎天然素材を使用しておりますので生産毎により色の濃淡や、材質の風合いに個体差が生じます。

Dust brush set
 Model R655-794
 H.30 W.160 D.110mm
 ¥2,400+税
 材質：天然木、PP50%、
 豚毛 50%、スチール



◎天然素材を使用しておりますので生産毎により色の濃淡や、材質の風合いに個体差が生じます。



Dustpan & broom

H.970 W.260 D.232mm
 Dust pan H.790 W.260 D.232mm
 Broom H.930 W.220 D.45mm
 ¥3,600+税

材質：馬毛、PBT
 フナ材(クリアマットラッカー仕上げ)
 スチール



Silver
 Model H20-0183SV
 4 997337 067522

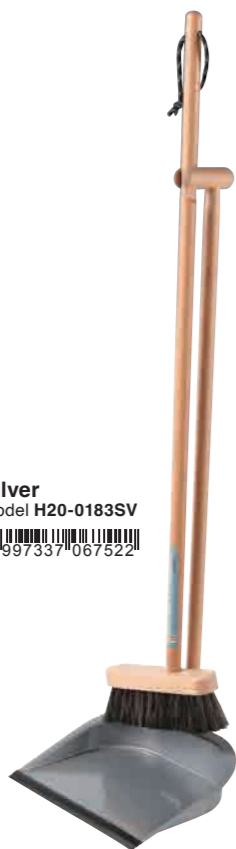

Olive drab
 Model H20-0183OV
 4 997337 067546



Gray
 Model H20-0183GY
 4 997337 067553



Galvanized bucket

材質：ガルバニズドスチール



1L
 Model H19-0047-1
 H.130 W.155 D.140mm
 ¥1,400+税
 4 997337 059183



4L
 Model H19-0047-4
 H.190 W.235 D.215mm
 ¥2,100+税
 4 997337 059176



6L
 Model H19-0047-6
 H.235 W.265 D.250mm
 ¥2,300+税
 4 997337 059169



12L
 Model H19-0047-12
 H.310 W.310 D.305mm
 ¥3,000+税
 4 997337 059145

Galvanized bucket

材質：ガルバニズドスチール (粉体塗装)



1L Olive drab
 Model H19-0047-10V
 H.130 W.155 D.140mm
 ¥1,400+税
 4 997337 067249



6L Olive drab
 Model H19-0047-60V
 H.235 W.265 D.250mm
 ¥2,300+税
 4 997337 067225



6L Gray
 Model H19-0047-6GY
 H.235 W.265 D.250mm
 ¥2,300+税
 4 997337 067263



12L Olive drab
 Model H19-0047-120V
 H.310 W.310 D.305mm
 ¥3,000+税
 4 997337 067218



12L Gray
 Model H19-0047-12GY
 H.310 W.310 D.305mm
 ¥3,000+税
 4 997337 067256

Deck brush

H.1165 W.153 D.43mm
 ¥1,300+税

材質：PET、フナ材(マットラッカー仕上げ)



Yellow
 Model H20-0184YL
 4 997337 067560



Olive drab
 Model H20-0184OV
 4 997337 067577



Gray
 Model H20-0184GY
 4 997337 067584



KITCHENWARE

SMALL SUNDRIES



ORGANIZING &
CLEANING SUPPLIES
COLLECTION



S/2 Cellulose cloth

H.195 W.170mm
¥620+税
材質：セルロース、綿



◎2枚1セット

Back



Gray

Model RN-0503GY 4 997337 085380



Purple

Model RN-0503PL 4 997337 085373

Orange

Model RN-0503OR 4 997337 085397



Cellulose cloth L

H.250 W.300mm
¥700+税
材質：セルロース、綿

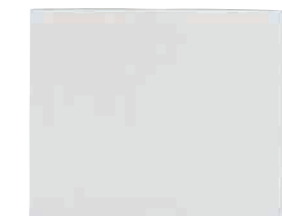
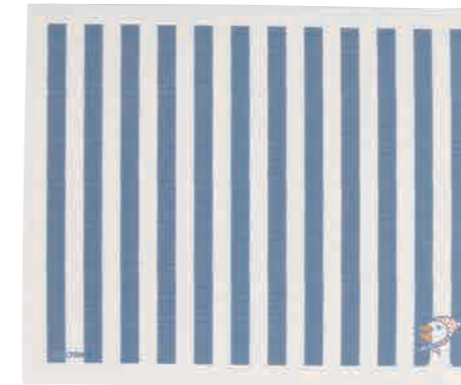

Back

White

Model RN-0540L/WT 4 997337 086806



Orange

Model RN-0540L/OR 4 997337 086820



Yellow

Model RN-0540L/YL 4 997337 086813

NEW ARRIVAL

CAR & OUTDOOR

FURNITURE

HOUSEWARE

GARDEN & GREEN

KITCHENWARE

SMALL SUNDRIES



Pinch hanger

材質：本体 / アルミニウム
ピンチ、フック / 201ステンレススチール
ワイヤー / 304ステンレススチール
リング / ジンクアロイ



S / 12clips
Model RN-0429S/12
H.17 W.268 D.119mm
¥980+税

4 997337 081283

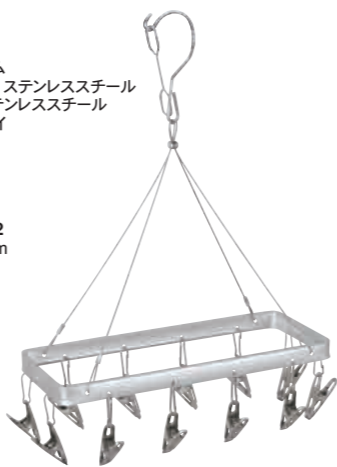

Package

L / 26clips
Model RN-0429L/26
H.17 W.357 D.270mm
¥2,100+税

4 997337 081313

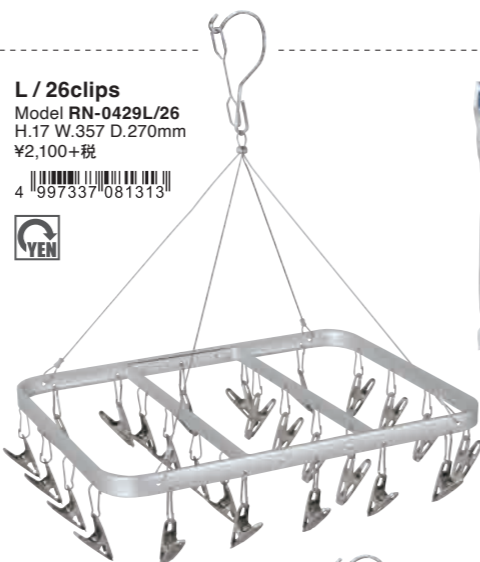

Package

Long / 12clips
Model RN-0429LG/12
H.17 W.375 D.80mm
¥980+税

4 997337 081290

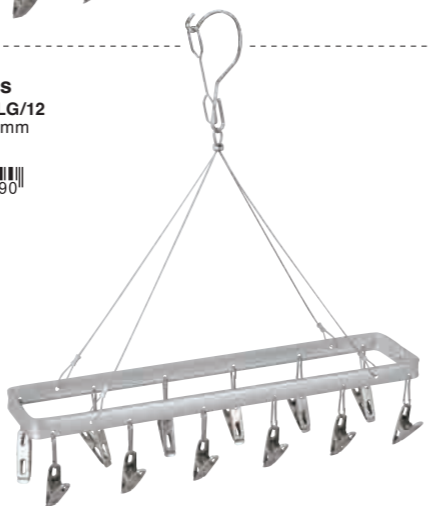

Package

Stainless steel clothespins

材質：201ステンレススチール、アルミニウム、スチール



S/5
Model RN-0425-5
H.83 W.25 D.46mm
5pcs / set
¥450+税

4 997337 081184

Package



S/10
Model RN-0425-10
H.83 W.25 D.46mm
10pcs / set
¥850+税

4 997337 081191

Package



35pcs PP Clothespins in bottle

材質：ポリプロピレン、アイアン(亜鉛メッキ)



Model RN-0427-35
Bottle H.165 W.93 D.93mm
Clothespin H.75 W.23 D.12mm / pc
35pcs / set
¥900+税

LOT 6Bottles 4 997337 081245

Urethane kitchen sponge S/6

材質：ポリウレタン



Model RN-0431
H.29 W.112 D.72mm / pc
6pcs / set
¥580+税

4 997337 081337



Package

◎ロットによりスポンジの濃淡に個体差があります。

3 Layers sponge S/6

材質：ポリウレタン、ポリエステル、ナイロン

Model RN-0430
H.35 W.127 D.67mm / pc
6pcs / set
¥780+税

4 997337 081320

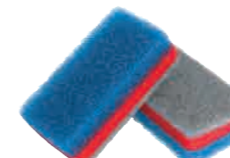

Package

◎ロットによりスポンジの濃淡に個体差があります。



Squeegee

H.265 W.210mm D.35mm
¥1,200+税
材質：ワイパー、ストラップ/TPR
ハンドル/ポリプロピレン



Red
Model RN-0542RD
4 997337 086882



Blue
Model RN-0542BL
4 997337 086875



Gray
Model RN-0542GY
4 997337 086868



Spray bottle pro 1000

H.325 W.105 D.87mm 1000ml
¥600+税
材質：本体/HDPE
スプレー/ポリプロピレン、ステンレススチール



LOT 2pcs

◎ノズルを回すことにより
ストレートorミストの調整可能。



Blue
Model RNR-0470BL
4 997337 083980



Red
Model RNR-0470RD
4 997337 083973



Back



Lambswool duster

材質：羊毛、ピーチ材、ポリプロピレン



Mini
Model RN-0428S
L.300mm
¥1,200+税
4 997337 081269



Long
Model RN-0428L
L.700mm
¥1,900+税
4 997337 081276



Package



Feather duster

材質：オーストリッチフェザー
竹、合成皮革



Mini White
Model H20-0138WT
L.205mm
Handle L.95mm
¥900+税
4 997337 065764



Mini Gray
Model H20-0138GY
L.205mm
Handle L.95mm
¥900+税
4 997337 065771



40cm
Model S455-190-4
L.400mm
Handle L.220mm
¥1,700+税
4 997337 4519045



60cm
Model S455-190-6
L.600mm
Handle L.420mm
¥2,000+税
4 997337 4519069



オーストリッチフェザー製品について

◎羽根部分は天然の材質を使用している為、
水洗いや洗剤等のご使用はお止めください。
◎羽根にクセをつけにくくする為、長期間ご使用に
ならない時は、吊るす等して羽根に負荷を
掛けない様に保管してください。
◎使用後はホコリをふるい落とし、
風通しの良い場所に保管してください。



Italian basin

材質：ポリプロピレン
耐熱温度 120℃ 耐冷温度 -20℃



9L
H.160 φ365mm
¥600+税



9L / Coral red
Model RN-0417-RD9 4 997337 080873



9L / Silver
Model RN-0417-SV9 4 997337 080897



9L / White
Model RN-0417-WT9 4 997337 080903

15L
H.180 φ400mm
¥800+税



15L / Coral red
Model RN-0418-RD15 4 997337 080910



15L / Silver
Model RN-0418-SV15 4 997337 080934



15L / White
Model RN-0418-WT15 4 997337 080941

Italian bucket kiko

材質：ポリプロピレン、スチール
耐熱温度 120℃ 耐冷温度 -20℃



10L
H.250 φ290mm
¥1,000+税



Coral red
Model RN-0419-RDB 4 997337 080958



Silver
Model RN-0419-SVB 4 997337 080972



White
Model RN-0419-WTB 4 997337 080989



Microfiber table wipes

H.60 W.200mm D.80mm
Cloth size 200×200mm
12 sheets

¥500+税
材質：ポリエステル85%
ポリアミド15%

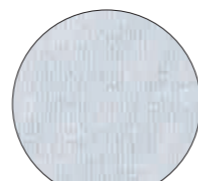

White
Model XR23-0530WT
4 997337 086516

White

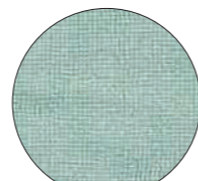

Mint green
Model XR23-0530MGN
4 997337 086509

Mint green



S/3 Waffle indie hand towel

320×320mm
¥1,650+税
材質：コットン100%

◎3枚1セット

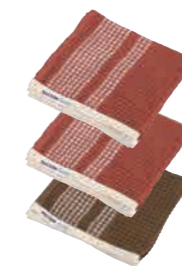

Red & Brown
Model RNZ-0471RD/BR
4 997337 083997



Red×2pcs



Brown×1pc

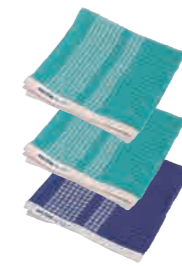

Gray green & Blue
Model RNZ-0471GG/BL
4 997337 084000



Gray green×2pcs



Blue×1pc



Waffle indie towel

1200×500mm
¥2,000+税
材質：コットン100%

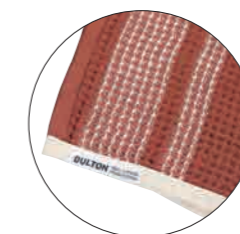

Red
Model RNZ-0472RD
4 997337 084017

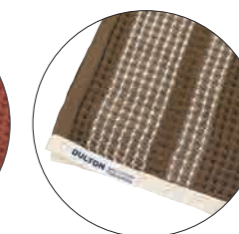

Brown
Model RNZ-0472BR
4 997337 084024

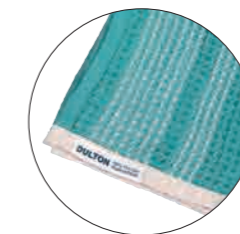

Gray green
Model RNZ-0472GG
4 997337 084031

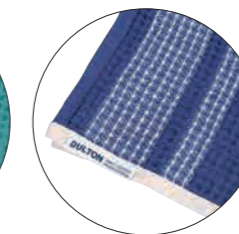

Blue
Model RNZ-0472BL
4 997337 084048



◎こちらのページの製品はハンドメイドのため、サイズや色の濃淡・材質の風合いに多少の個体差があります。製品の特性としてご理解ください。



Towel holder square

55×55 D.23mm
材質：18-0ステンレススチール、TPR
強力両面テープ付属



Ivory
Model CH04-H116IV
¥800+税
4 997337 078535

Satin finish
Model CH04-H116
¥800+税
4 997337 411608

Towel holder round

φ55 D.23mm
材質：18-0ステンレススチール、TPR
強力両面テープ付属



Ivory
Model CH04-H117IV
¥800+税
4 997337 078542

Mirror finished
Model CH04-H117
¥800+税
4 997337 411707

◎ざらつき及び凸凹がある場所には取り付けできません。

4-holes toothbrush holder

H.120 φ70mm



Ivory
Model CH03-H92IV
¥1,500+税
材質：Top / 18-0ステンレススチール
Bottom / 439ステンレススチール
4 997337 078658

Satin finish
Model CH03-H92ST
¥1,400+税
材質：304ステンレススチール
4 997337 723008

Mirror finished
Model CH03-H92MF
¥1,500+税
材質：304ステンレススチール
4 997337 723015

Tube squeezer with stand

Model H21-0366
H.40 W.86 D.30mm
¥1,500+税

材質：304ステンレススチール
4 997337 078757



Dental floss
Model S175-34
Case H.38 W.26 D.15mm
(チェーン除く)
15m /roll
¥250+税
材質：ナイロン(フロス)
LOT 15pcs
4 997337 175340

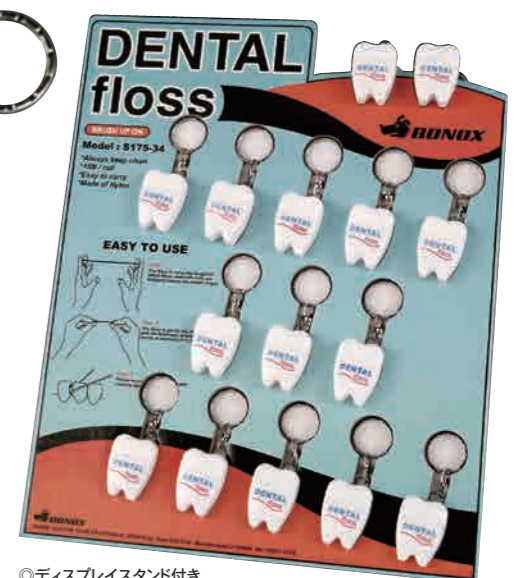

◎ディスプレイスタンド付き



Magnetic soap holder
Model CH12-H463
W.50 D.65mm
¥900+税



◎ホルダー部分に固形石けんをセットして使用します。
◎ざらつき及び、凹凸のある設置面には取り付けできません。
◎石けんは付属しません。



Stainless steel soap dispenser
Model K755-921
H.110 φ115mm 450ml
¥2,400+税
液体タイプ専用
材質：本体/18-8ステンレススチール
ポンプ/ポリエチレン



Stainless steel soap dispenser
Model K755-917
H.120 W.105 D.100mm 500ml
¥2,400+税
液体タイプ専用
材質：本体/18-8ステンレススチール
ポンプ/ポリエチレン



Rectangle mirror with tray
Model K755-920 H.245 W.120 D.120mm
¥2,200+税 Mirror 150×105mm



Rectangle mirror with tray W18
Model K855-1098 H.238 W.200 D.133mm
¥2,600+税 Mirror 135×180mm



Rectangle stand mirror
Model G755-906 H.310 W.165 D.135mm
¥3,500+税 Mirror 230×165mm



Stainless steel tumbler
Model K555-348
H.95 φ75mm 400ml
¥1,000+税



**Dust bin "Tambor" 1L
Satin finished**
Model K555-527ST
H.140 φ120mm
¥3,200+税

Tissue dispenser
Model TD08-313
H.55 W.265 D.140mm
Inside H.50 W.260 D.122mm
Weight 0.6kg
¥6,200+税
◎壁取り付け可能。
◎ティッシュペーパーは付属しません。



Round stand mirror
Model G755-903 H.280 W.165 D.120mm
¥2,400+税 Mirror φ150mm
両面鏡：片面3倍鏡



Round stand mirror
Model G755-905 H.225 W.185 D.150mm
¥2,400+税 Mirror φ170mm
両面鏡：片面3倍鏡



Swing stand mirror
Model G755-904 Base size 100×160mm
¥2,800+税 Base arm L.140mm
Mirror φ170mm
両面鏡：片面3倍鏡



Tissue dispenser
Model 100-160N
H.145 W.260 D.125mm
Inside H.100 W.240 D.110mm
Weight 1.2kg



Color	Price	Barcode
Vibration	¥6,900+税	4 997337 068666
Stainless	¥6,800+税	4 997337 860994
Ivory		4 997337 860918
Red		4 997337 860925
Yellow		4 997337 860932
Sax	¥3,600+税	4 997337 860949
H.gray		4 997337 860970
Olive		4 997337 068673



付属のラバースタンドを使用する事で、置き型のディスペンサーとしても使用できます。

for your convenience

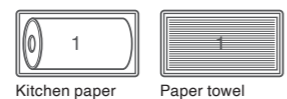

Tissue paper box L (~H.100mm) Tissue paper box S (~H.53mm)



Extending mirror
Model G755-907
¥3,000+税
H.375
Arm L.90~490mm
Mirror φ173mm
両面鏡：片面3倍鏡
取付ネジ付属



Enameled tumbler
Model H19-0093
H.95 φ90mm 290ml
¥800+税
材質：エナメル、スチール
LOT 4pcs



Enameled utensil pot
Model H19-0097
H.123 φ123mm
¥1,000+税
材質：エナメル、スチール



Enameled soap dish
Model CH13-H490
H.25 W.155 D.105mm
¥1,200+税
材質：エナメル、スチール



Enameled washbowl 
材質：エナメル、スチール

S
Model H19-0096S
H.113 φ229mm
¥1,300+税



M
Model H19-0096M
H.130 φ276mm
¥1,700+税



Cement organizer soap dish 
H.13 W.120 D.80mm
¥300+税
LOT 6pcs



Sand
Model H20-0261LGY
4 997337 072601



Slate
Model H20-0261DGY
4 997337 072618

◎ハンドメイドのため、形やサイズ、風合いや色等に個体差があります。歪みや表面のキズ・ピンホール・ヒビ等が見られる場合があります。製品の特性としてご理解ください。
◎セメントに水が沁み込み、設置箇所が濡れる恐れがあります。設置場所にはご注意ください。

Fake trigger bottle

材質：本体/ガラス
スプレー/ポリプロピレン

30ml
H.128 W.55 D.26mm
¥200+税
LOT 6pcs



Clear
Model H20-0255S/CL
4 997337 072373



Smoke
Model H20-0255S/SM
4 997337 072380



Blue
Model H20-0255S/BL
4 997337 072397



Yellow
Model H20-0255S/YL
4 997337 072403



Pink
Model H20-0255S/PK
4 997337 072410



Green
Model H20-0255S/GN
4 997337 072427

80ml
H.160 W.61 D.31mm
¥300+税
LOT 6pcs



Clear
Model H20-0255M/CL
4 997337 072434



Smoke
Model H20-0255M/SM
4 997337 072441



Blue
Model H20-0255M/BL
4 997337 072458



Yellow
Model H20-0255M/YL
4 997337 072465



Pink
Model H20-0255M/PK
4 997337 072472



Green
Model H20-0255M/GN
4 997337 072489

◎詰替専用ボトルです。液体を補充する際は“じょうご”をご使用ください。◎トリガーノズルは装飾品としてのキャップです。押し込んで破損しないようご注意ください。

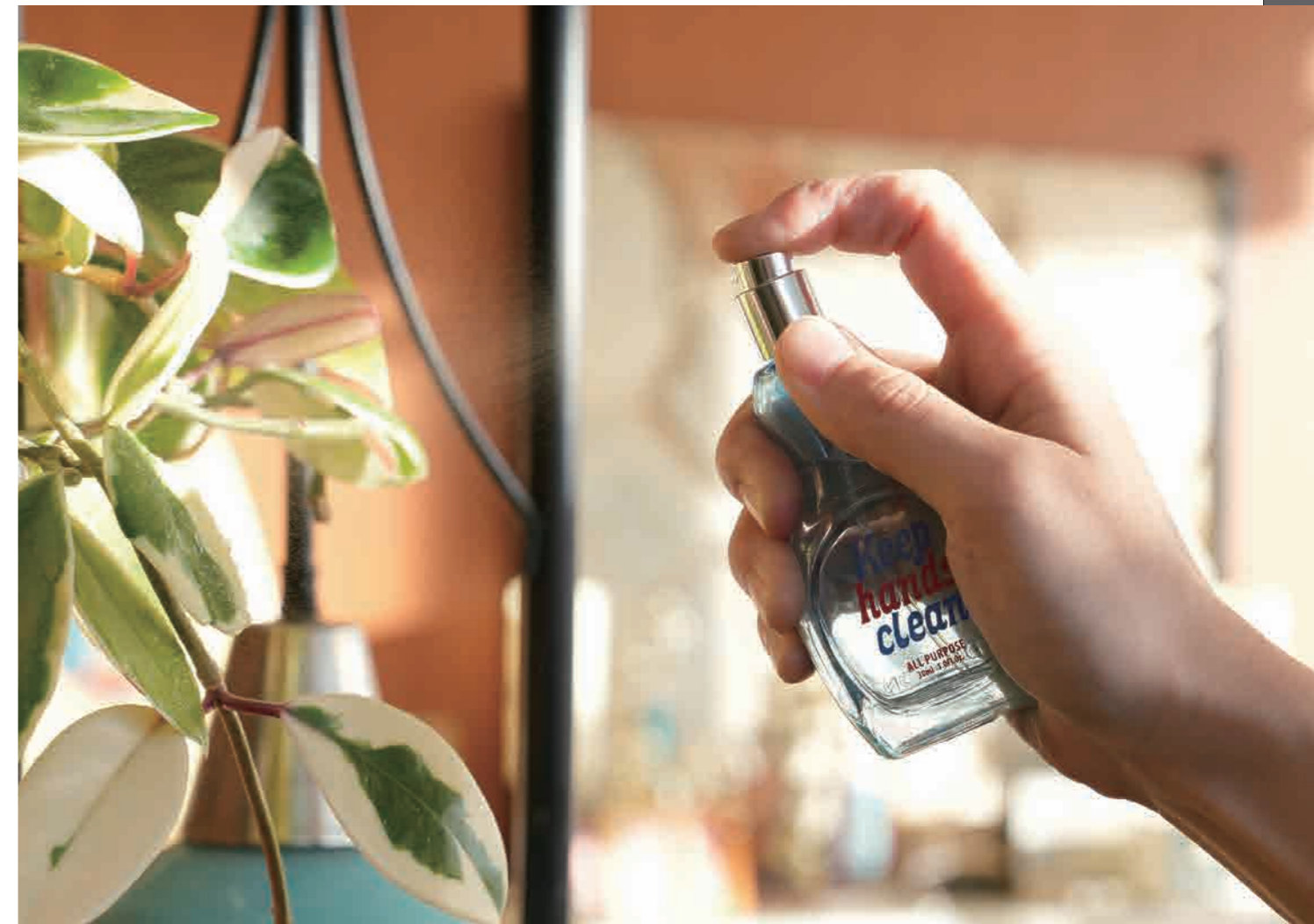



Paper holder
材質：アイアン

Single
H.40 W.140 D.115mm



Antique brass
Model H20-0206ABS
¥1,600+税

Black
Model H20-0206BK
¥1,400+税



Single cover
H.65 W.125 D.110mm



Antique brass
Model H20-0207ABS
¥2,000+税

Black
Model H20-0207BK
¥1,800+税

◎トイレットペーパーは付属しません。

Paper holder
Model 7651N
W.150mm
¥2,800+税



◎トイレットペーパーは付属しません。

Towel ring
Model 7660
W.165 D.90mm
¥2,400+税



Single hook
Model XT-708
L.50 φ25mm
¥800+税



Shoehorn
材質：アルミニウム

L
Model H20-0248L
L.520 W.40mm
¥2,200+税
LOT 2pcs



S
Model H20-0248S
L.250 W.40mm
¥1,800+税
LOT 4pcs



Aluminum clothes hanger

Model CH10-H411
H.240 W.440 D.50mm
¥2,400+税
材質：アルミニウム

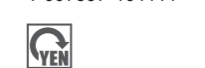

Aluminum clothes hanger

Model CH10-H411N
H.230 W.440 D.50mm
¥2,200+税
材質：アルミニウム



◎仕上げの際の細かな磨き跡が生じてしまう場合があります。製品の特性としてご理解ください。

Clothes brush

Model R655-796
L.225 35×35mm
¥1,000+税
材質：天然木・牛革
馬毛100%



Folding hanger

Model 121-374
H.200 W.450 D.47mm
Folding 240×55×47mm
¥800+税
材質：スチール（粉体塗装）

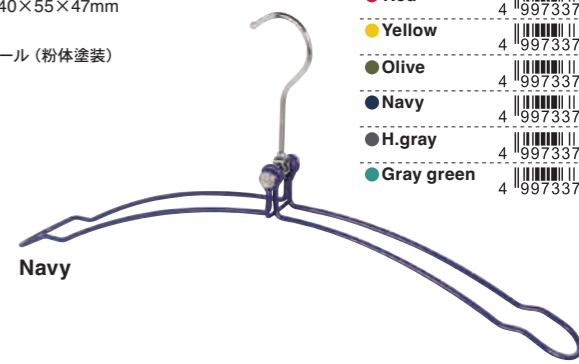

Color	Barcode
Ivory	4 997337 077767
Red	4 997337 077774
Yellow	4 997337 077781
Olive	4 997337 077811
Navy	4 997337 077750
H.gray	4 997337 077804
Gray green	4 997337 077798

Foldable tissue box

H.77 W.260 D.140mm
Inside H.65 W.250 D.125mm
¥2,800+税
◎形状によっては収納できません。

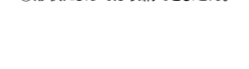

Beige

Model H20-0155BE
材質：ポリウレタン
マイクロファイバー

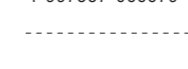

Dark cork

Model H20-0155DCK
材質：コルクシート、ポリウレタン
マイクロファイバー

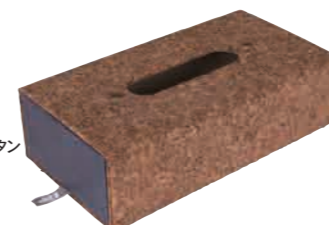
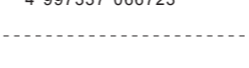

Dark brown

Model H20-0155DBR
材質：ポリウレタン
マイクロファイバー

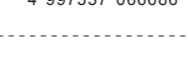

Light denim

Model H20-0155LDM
材質：コットン、ポリウレタン
マイクロファイバー

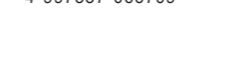

Navy

Model H20-0155NB
材質：ポリウレタン
マイクロファイバー

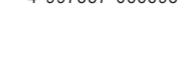



WALL CLOCK "BRISTOL"

DOUBLE FACE CLOCK RECTANGLE

Wall clock "Bristol"



S-30 BD
Model K725-925BD
φ305 D.65mm
¥7,000+税
使用電池 単3×1pc
Sweep movement
4 997337 792578



S-40 BD
Model K725-924BD
φ405 D.80mm
¥10,000+税
使用電池 単3×1pc
Sweep movement
4 997337 792493



Double face clock rectangle



Model H21-0362
H.187 W.442 D.98mm
Weight 約2kg
¥19,000+税
材質：ABS樹脂、PP、ガラス、アルミニウム
使用電池 単3×2pcs
Sweep movement



Black
Model H21-0362BK 4 997337 078559



Dark green
Model H21-0362DGN 4 997337 078573



Gray
Model H21-0362GY 4 997337 078566



S-30 WD
Model K725-925WD
φ305 D.65mm
¥7,000+税
使用電池 単3×1pc
Sweep movement
4 997337 792516



S-40 WD
Model K725-924WD
φ405 D.80mm
¥10,000+税
使用電池 単3×1pc
Sweep movement
4 997337 792417



Double face clock 170D

Model S624-659
H.205 W.285 D.90mm
Weight 1.5kg
¥11,000+税
使用電池 単3×2pcs
Sweep movement



Silver
4 997337 665988



Ivory
4 997337 665919



Black
4 997337 665995

Double face wall clock

Model S82429
H.380 W.445 D.130mm
Weight 3kg
¥19,000+税
使用電池 単3×2pcs
Sweep movement



Ivory
4 997337 242912



Silver
4 997337 242998



Black
4 997337 242981

Wall clock "Northrop"



S-51 WD
Model K725-923WD
φ520 D.90mm
¥13,000+税
使用電池 単3×1pc
Sweep movement
4 997337 792318



G-30 WD
Model K725-927WD
φ305 D.55mm
¥5,000+税
使用電池 単3×1pc
Sweep movement
4 997337 792714





Bohumil clock

H.220 W.215 D.80mm
 材質：スチール
 使用電池 単3×1pc
 Sweep movement



Chrome
 Model K925-1256CR
 ¥6,000+税
 4 997337 925617



Black
 Model K925-1256BK
 ¥4,700+税
 4 997337 925624



Khaki
 Model K925-1256KH
 ¥4,700+税
 4 997337 925631

Rainard clock

H.185 W.225 D.65mm
 材質：スチール
 使用電池 単3×1pc
 Sweep movement



Chrome
 Model K925-1257CR
 ¥5,700+税
 4 997337 925716



Ivory
 Model K925-1257IV
 ¥4,500+税
 4 997337 925730



Gray
 Model K925-1257GY
 ¥4,500+税
 4 997337 925747

Wall clock

Model H20-0246
 φ240 D.78mm
 ¥4,200+税
 材質：スチール、ガラス
 使用電池 単3×1pc
 Sweep movement



Classic gray
 4 997337 070621

Wall clock

Model S426-207
 φ210mm D.65mm
 ¥4,200+税
 使用電池 単3×1pc
 Sweep movement



Red
 4 997337 620727



Ivory
 4 997337 620710



Sage Green
 4 997337 620765



Black
 4 997337 620796



Classic Gray
 4 997337 620789





Alarm clock (quartz)

Model 100-053Q
H.110 W.90 D.70mm
使用電池 単3×1pc



Chrome



Ivory



Red



Yellow



Sax



Blue



Black



Olive

Color	Price	Barcode
● Chrome	¥2,900+税	4 997337 105309
● Ivory		4 997337 105316
● Red		4 997337 105323
● Yellow		4 997337 105347
● Sax	¥2,700+税	4 997337 105354
● Blue		4 997337 105330
● Black		4 997337 105361
● Olive		4 997337 067379

Square alarm clock

ワイヤースタンドなし H.71 W.71 D.40mm
ワイヤースタンドあり H.78 W.71 D.75mm
¥1,200+税

材質：スチール、ガラス
使用電池 単3×1pc
Sweep movement



Red
Model H20-0178RD
4 997337 067300



Sax
Model H20-0178SB
4 997337 067324

Magnetic clock

¥1,700+税



材質：スチール、ガラス、マグネット付き
使用電池 LR44×1pc
Step movement

Round / Ivory

Model H20-0244ROIV
H.73 W.65 D.23mm



Rectangle / Ivory

Model H20-0244RCIV
H.51 W.71 D.22mm



Round / Black

Model H20-0244ROBK
H.73 W.65 D.23mm



Rectangle / Black

Model H20-0244RCBK
H.51 W.71 D.22mm



Thermo-hygrometer

¥1,400+税



材質：スチール、ガラス
マグネット付き



Round

Model K925-1283RD
H.73 W.65 D.23mm



Package



Mexico

Model K925-1283MX
H.73 W.65 D.23mm



Package



Rectangle

Model K925-1284RC
H.51 W.71 D.22mm



Package



Beer

Model K925-1284BE
H.51 W.71 D.22mm



Package





Aluminum wall rack

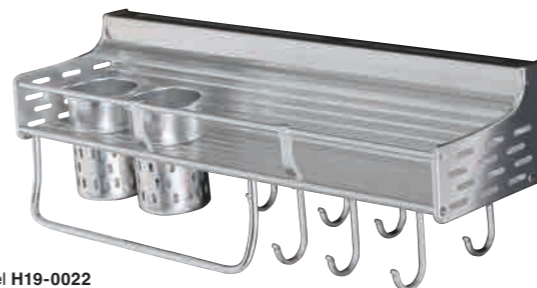

Model H19-0022
H.190 W.500 D.155mm
¥6,000+税
4 997337 007670



Model H19-0023
H.220 W.600 D.250mm
¥8,500+税
4 997337 007894

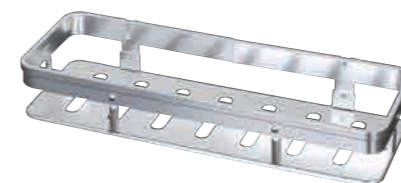

Aluminum wall shelf
Model H19-0026
H.67 W.400 D.140mm
¥2,800+税
4 997337 007962



Aluminum wall shelf 2tier
Model H19-0025
H.355 W.400 D.140mm
¥5,800+税
4 997337 007955



Stainless magnetic tool holder 材質：18-8ステンレススチール
マグネット
取付け用ネジ 2pcs 付属



25
Model G655-750-25
H.47 W.250 D.15mm
¥2,600+税
4 997337 675017



45
Model G655-750-45
H.47 W.450 D.15mm
¥3,600+税
4 997337 675024

Bamboo magnetic tool holder 材質：バンブー、マグネット
取付け用ネジ 2pcs 付属



25
Model G655-752-25
H.65 W.250 D.20mm
¥2,700+税
4 997337 675215



45
Model G655-752-45
H.65 W.450 D.20mm
¥4,200+税
4 997337 675222

HOUSEWARE

GARDEN & GREEN

KITCHENWARE

SMALL SUNDRIES



Aluminum bar handle
 材質：アルミニウム
 取付ビス付属



S
 Model D21-0330S
 H.300 W.35 D.65mm
 ¥3,500+税
 4 997337 076838



L
 Model D21-0330L
 H.600 W.40 D.65mm
 ¥5,000+税
 4 997337 076821



Aluminum door handle
 材質：アルミニウム
 取付ビス付属



Model D21-0328
 H.60 W.136 D.50mm
 ¥1,800+税
 4 997337 076807



Model D21-0329
 H.120 W.90 D.60mm
 ¥6,000+税
 4 997337 076814



Model D21-0331
 H.60 W.110 D.42mm
 ¥2,000+税
 4 997337 076845



Handle
 Model K555-499
 材質：アイアン



L
 H.350 W.35 D.75mm
 ¥1,750+税
 4 997337 549936

Door Handle
 Model K555-502
 材質：アイアン



S
 H.240 W.42 D.55mm
 ¥950+税
 4 997337 550215

L
 H.310 W.45 D.60mm
 ¥1,350+税
 4 997337 550239



Triangle hook
 H.160 W.160 D.50mm
 ¥950+税
 材質：アイアン
 取付ビス付属



Black
 Model D20-0121BK
 4 997337 063548

Side

◎アイアン製品は、アンティークの雰囲気を出す為の仕上げ(色ムラ・塗装はがれ等)が施されており、
 ◎塗装の風合いに多少の個体差があります。◎設置面に「サビ」が色移りする場合があります。製品の特性としてご理解ください。

Bar
材質：アイアン
取付ビス付属

Bar 25
H.70 W.250 D.60mm
¥900+税

Black
Model D20-0122-2BK
4 997337 064378



Gold
Model D20-0122-2GD
4 997337 064385



Bar 50
H.70 W.500 D.60mm
¥1,000+税

Black
Model D20-0122-5BK
4 997337 063555



Gold
Model D20-0122-5GD
4 997337 063562



Bar 60
H.70 W.600 D.60mm
¥1,100+税

Black
Model D20-0122-6BK
4 997337 063579



Gold
Model D20-0122-6GD
4 997337 063586



Bar 70
H.70 W.700 D.60mm
¥1,150+税

Black
Model D20-0122-7BK
4 997337 063593



Gold
Model D20-0122-7GD
4 997337 063609



Belt bracket



Belt bracket

Model Y955-1249
H.168 W.40 D.230mm
¥1,650+税

木板サイズ：H.25 D.200mm 以内
1×8材 (19×184mm) が収まります。

4 997337 924917

Belt bracket with ring

Model Y955-1249R
H.168 W.40 D.230mm
¥1,850+税

木板サイズ：H.25 D.200mm 以内
1×8材 (19×184mm) が収まります。
リングに入る丸棒サイズ：φ25mm 以内

4 997337 924924

Adjustable bracket



S
Model K655-699S
H.90 W.120 D.35mm
¥850+税

4 997337 669917



L
Model K655-699L
H.140 W.180 D.55mm
¥1,650+税

4 997337 669931



Hanging bracket
Model R855-1009
H.175 W.32 D.160mm
¥1,250+税

4 997337 810098



Bracket 12
Model S555-376-12
H.120 W.120 D.26mm
¥650+税

4 997337 376129



Bracket
Model S555-376
H.185 W.185 D.30mm
¥900+税

4 997337 553766



Bracket
Model S555-375
H.210 W.210 D.25mm
¥1,250+税

4 997337 553759

Bracket



Bracket 10
Model S355-85-10ABK
H.100 W.100mm
¥650+税

4 997337 859103



Bracket 14
Model S355-85-14ABK
H.140 W.140mm
¥850+税

4 997337 859141



Bracket 18
Model S355-85-18ABK
H.180 W.180mm
¥1,050+税

4 997337 859189



Bracket 23
Model S355-85-23ABK
H.230 W.230mm
¥1,450+税

4 997337 859233



Bracket 27
Model S355-85-27ABK
H.270 W.270mm
¥1,850+税

4 997337 859271

Bow bracket



Bow bracket "10"
Model S555-353-10
H.100 W.100mm
¥500+税

4 997337 353106



Bow bracket "14"
Model S555-353-14
H.140 W.140mm
¥750+税

4 997337 353144



Bow bracket "19"
Model S555-353-19
H.195 W.195mm
¥1,050+税

4 997337 353199



Bow bracket "25"
Model S555-353-25
H.250 W.250mm
¥2,250+税

4 997337 353250

◎こちらのページに掲載されている製品は、アンティークの雰囲気を出す為の仕上げ(色ムラ・塗装はがれ等)が施されており、塗装の風合いに多少の個体差があります。◎設置面に「サビ」が色移りする場合があります。製品の特性としてご理解ください。材質：アイアン 取付ビス付属



Small double hook
Model S255-101ABK
H.80 W.32 D.48mm
¥400+税
4 997337 510196



Small single hook
Model S255-100ABK
H.33 W.24 D.33mm
¥350+税
4 997337 510097



Wall hook
Model S255-92ABK
H.75 W.35 D.85mm
¥450+税
4 997337 559218



Iron hook S
Model S255-91S/ABK
H.120 W.35 D.45mm
¥650+税
4 997337 959117



Ceiling s-hook
Model K655-702
H.78 W.48 D.98mm
¥650+税
4 997337 657020



Ceiling hook 60
Model S355-89ABK
H.75 W.80 D.48mm
¥450+税
4 997337 955898



Ceiling hook
Model S255-99ABK
H.100 W.105 D.70mm
¥750+税
4 997337 559911



Ceiling Ring S
Model R855-1008S
H.80 W.80 D.33mm
リング内径φ10mm
¥750+税
4 997337 7810814



2 swing wall hook
Model S255-89ABK
H.57 W.42 D.125mm
¥750+税
4 997337 558914



Double swing wall hook
Model S255-88ABK
H.83 W.40 D.70mm
¥550+税
4 997337 558815



Wave hook
Model S355-107ABK
H.190 W.40 D.175mm
¥700+税
4 997337 107990



Cloth rack hook
Model S355-108ABK
H.160 W.40 D.175mm
¥550+税
4 997337 108997



Bull skull hook
Model S555-379
H.145 W.140 D.65mm
¥950+税

Color
● Classic ivory
● Antique black



Lizard hook
Model S255-90ABK
H.180 W.86 D.50mm
¥900+税
4 997337 559010



Cats hook
Model HL4360-6ABK
H.90 W.200mm
¥1,300+税
4 997337 943604



2 branch hook S
Model S355-91S/ABR
H.200 W.100 D.60mm
¥900+税
4 997337 591812



2 branch hook
Model S355-92ABR
H.90 W.135 D.58mm
¥650+税
4 997337 559287



Left direction
Model S355-93ABK
H.56 W.128 D.15mm
¥450+税
4 997337 593090



Right direction
Model S355-94ABK
H.56 W.128 D.15mm
¥450+税
4 997337 594097

◎こちらのページに掲載されている製品は、アンティークの雰囲気を出す為の仕上げ(色ムラ・塗装はがれ等)が施されています。
◎塗装の風合いに多少の個体差があります。
◎設置面に「サビ」が色移りする場合があります。製品の特性としてご理解ください。
材質: アイアン 取付ビス付属

Hanging sign
材質: アイアン
取付ビス付属



28
Model R655-747-28
H.190 W.280 D.30mm
Board H.110 W.240mm
¥2,100+税
4 997337 747288



35
Model R655-747-35
H.225 W.345 D.40mm
Board H.140 W.300mm
¥2,900+税
4 997337 747356



Metal chalkboard
材質: スチール



13
Model K955-1264-13
H.135 W.210 D.75mm
¥1,600+税
4 997337 212649



27
Model K955-1264-27
H.270 W.210 D.140mm
¥2,700+税
4 997337 112642

◎こちらのページに掲載されている製品は、アンティークの雰囲気を出す為の仕上げ(色ムラ・塗装はがれ等)が施されています。
◎塗装の風合いに多少の個体差があります。◎設置面に「サビ」が色移りする場合があります。製品の特性としてご理解ください。



**Reversible sign stand
Open-close**
Model S455-1800C
H.95 W.165 D.72mm
¥1,500+税
4 997337 551809

◎両面が利用可能です。



**Reversible sign stand
Reserved**
Model S455-175RE
H.85 W.155 D.72mm
¥1,300+税
4 997337 451758

◎両面が利用可能です。
◎両面とも「RESERVED」表示です。



Reversible sign
Model S455-1740C
H.95 W.165mm
¥1,600+税
4 997337 551748

◎両面が利用可能です。

**Reversible sign stand
"CASHIER"**
Model R655-744
H.80 W.160 D.65mm
¥1,300+税
4 997337 657440

Iron sign
材質：アイアン
取付ビス付属



"TOILET"
Model 405
H.50 W.175mm
¥1,100+税
4 997337 405393



"STAFF ONLY"
Model 2430
H.50 W.225mm
¥1,400+税
4 997337 224307



Iron sign "Bicycle parking"
Model R855-994
H.145 W.195 D.5mm
¥1,500+税



材質：アイアン
取付ビス付属

Iron sign "NO PARKING"
Model R655-745
H.120 W.190 D.5mm
¥1,200+税
4 997337 657457



Black
4 997337 899413



Blue
4 997337 899420

◎こちらのページに掲載されているアイアン製品は、アンティークの雰囲気を出す為の仕上げ（色ムラ・塗装はがれ等）が施されています。
◎塗装の風合いに多少の個体差があります。
◎設置面に「サビ」が色移りする場合があります。製品の特性としてご理解ください。

Brass sign
Model GS559-326
H.23 W.145 D.4mm
¥1,000+税

材質：真鍮



"GENTS"

Color	Model	Price
GENTS	GS559-326GE	¥1,000+税 4 997337 326018
LADIES	GS559-326LA	¥1,000+税 4 997337 326025
OFFICE	GS559-326OF	¥1,000+税 4 997337 326087



"LADIES"



"OFFICE"



付属品
プラスビス×2pcs（マイナス）

◎ハンドメイドのため、サイズ等の若干の個体差が生じる場合があります。
◎生産工程に細かなキズや塗装剥げ等が生じる場合がありますが、製品の特性としてあらかじめご了承ください。

Enameled sign 材質：エナメル、スチール
取付ビス付属



Men
Model H20-0145MN
H.40 W.150 D.5mm
¥500+税
4 997337 066099



Women
Model H20-0145WM
H.40 W.150 D.5mm
¥500+税
4 997337 066105



Push
Model H20-0145PS
H.40 W.150 D.5mm
¥500+税
4 997337 066129



Pull
Model H20-0145PL
H.40 W.150 D.5mm
¥500+税
4 997337 066136



Private
Model H20-0145PR
H.40 W.150 D.5mm
¥500+税
4 997337 066112



Staff only
Model H20-0145SO
H.40 W.210 D.5mm
¥600+税
4 997337 066051

Enameled notice sign H.120 W.170 D.5mm
¥800+税

材質：エナメル、スチール
取付ビス付属



Wash your hands
Model H20-0144WH
4 997337 064767



Hand sanitizer
Model H20-0144HS
4 997337 064781



Take out
Model H20-0144TO
4 997337 066006



No parking
Model H20-0144NP
4 997337 066020



Blank
Model H20-0144BL
4 997337 066044



NEW ARRIVAL

CAR & OUTDOOR

FURNITURE

HOUSEWARE

GARDEN & GREEN



Art frame
材質：天然木、ガラス、MDF



Paradise
Model XR22-0433P
H.600 W.400 D.30mm
Weight 約2.5kg
¥6,000+税
4 997337 082884



Aero
Model XR22-0433A
H.600 W.400 D.30mm
Weight 約2.5kg
¥6,000+税
4 997337 082907



Black owl
Model XR22-0433BO
H.600 W.400 D.30mm
Weight 約2.5kg
¥6,000+税
4 997337 082921

Volkman
Model XR22-0433V
H.400 W.300 D.30mm
Weight 約1.3kg
¥4,200+税
4 997337 082877



"Medford"
Model G855-1047MF
H.475 W.320 D.34mm
Weight 約1.5kg
¥4,000+税
4 997337 847025



"My pal"
Model G855-1047MP
H.475 W.320 D.34mm
Weight 約1.5kg
¥4,000+税
4 997337 847032



Canvas art
材質：天然木、キャンバス、MDF



Old elm
Model XR22-0434OE
H.600 W.400 D.30mm
Weight 約1kg
¥5,800+税
4 997337 082938



Indian-A
Model XR22-0434A
H.700 W.400 D.30mm
Weight 約1.2kg
¥5,800+税
4 997337 082945

Galvanized frame stand
材質：スチール、MDF、アクリル



A4
Model RN-0400-A4
H.360 W.270 D.20mm
¥4,500+税
4 997337 080538

A3
Model RN-0400-A3
H.500 W.380 D.20mm
¥8,000+税
4 997337 080521

A1
Model RN-0400-A1
H.905 W.655 D.20mm
¥19,000+税
4 997337 080514

A0
Model RN-0400-A0
H.1245 W.905 D.20mm
¥36,000+税
4 997337 080507



Table double glass frame stand

材質：スチール、ガラス

A4

Model RN-0399-A4
H.290 W.213 D.85mm
¥4,500+税

4 997337 080491



Magnetic stand silver

材質：スチール (粉体塗装)



Model RN-0401
H.350 W.300 D.140mm
¥4,300+税

4 997337 080545

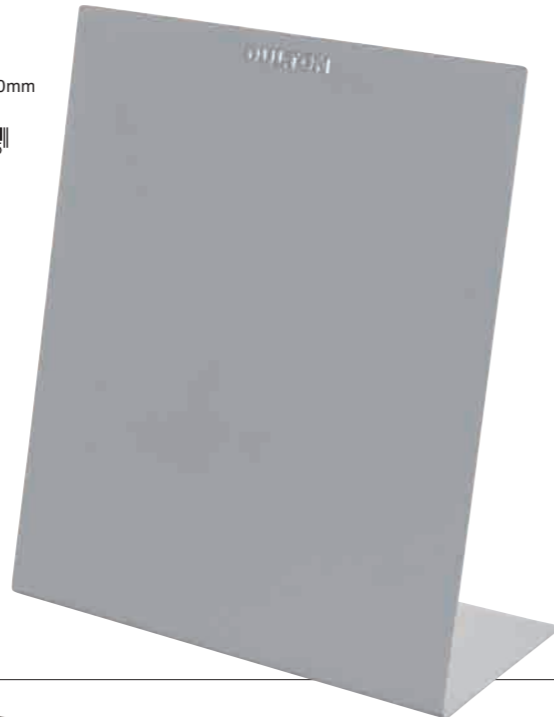

Metal frame

材質：スチール、ガラス



A6 / Vertical

Model K955-1263-A6
H.155 W.107 D.70mm
¥2,000+税

4 997337 080484



A5 / Vertical

Model K955-1263-A5
H.207 W.150 D.90mm
¥3,200+税

4 997337 080477



7

Model K955-1263-7
H.70 W.105 W.40mm
Frame H.57 W.95mm
¥1,000+税

4 997337 126335



10

Model K955-1263-10
H.105 W.155 D.65mm
Frame H.95 W.145mm
¥1,700+税

4 997337 126328



20

Model K955-1263-20
H.205 W.250 D.100mm
Frame H.195 W.240mm
¥3,500+税

4 997337 126311



Desktop wire stand

材質：スチール



M

Model RN-0442ZCM
H.230 W.110 D.35mm
¥550+税

4 997337 083126

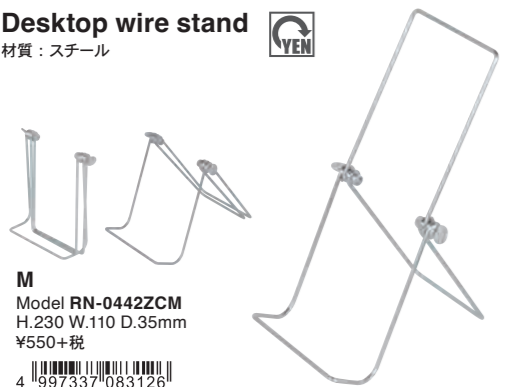

L

Model RN-0442ZCL
H.225 W.158 D.37mm
¥600+税

4 997337 083140

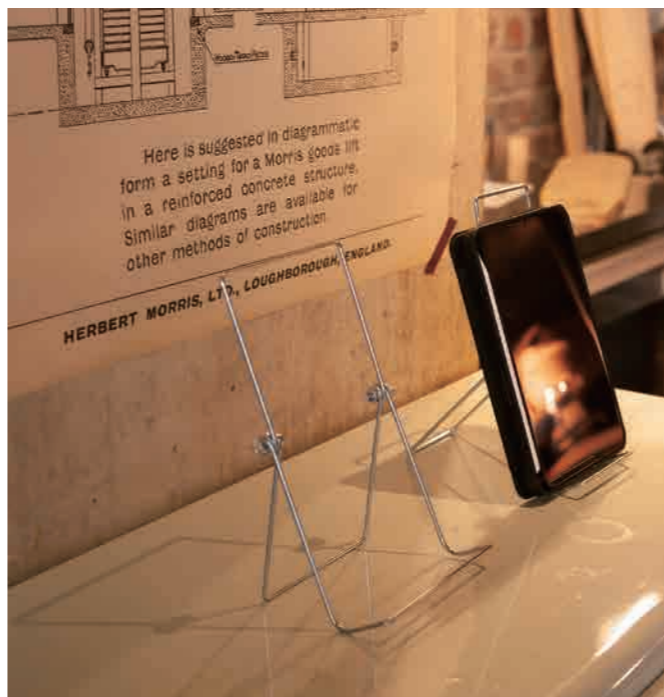

Table top mirror
材質：スチール、ガラス、MDF



Oval
Model H19-0111
H.322 W.155 D.120mm
Mirror H.215 W.125mm
¥3,600+税



Rectangle
Model H19-0114
H.377 W.320 D.127mm
Mirror H.300 W.198mm
¥5,300+税



Round
Model H19-0115
H.370 W.405 D.147mm
Mirror φ270mm
¥6,200+税



Wall hanging mirror

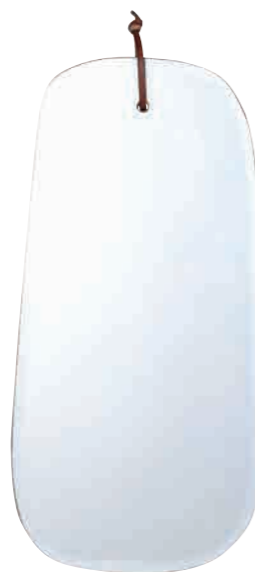

Cloud long
Model H19-0029
H.393 W.190 D.10mm
¥4,000+税



Cloud rounded
Model H19-0030
H.200 W.180 D.10mm
¥2,700+税



Cloud square
Model H19-0031
H.340 W.258 D.10mm
¥4,300+税



Cloud oblong
Model H19-0032
H.250 W.175 D.10mm
¥3,000+税



Cloud oval
Model H19-0033
H.240 W.265 D.10mm
¥3,600+税



Fragrance diffuser



H.120 φ60mm
リード L.250mm×8 pcs
容量 100ml
¥2,300+税
材質：本体 / 亜鉛合金、ガラス
スティック / 藤
使用期間目安 約30~45日



Magnolia orchid
Model G675-825BZ-MC
4 997337 682510



Pure silk
Model G675-825BS-PS
4 997337 682527



Black forest
Model G675-825BK-BF
4 997337 682534



Package

Fragrance tester
各香りの店頭展示サンプルをご用意しています。
ご希望の方は営業担当までお問い合わせください。

Stone diffuser 

◎天然石の為、形状、色調、重さに個体差があり、特有のクラックがあります。



Amber tuberose
Model BY-0421ATR
H.105 φ100mm
オイル容量 10ml
¥2,700+税
材質：水晶、シトリン、ガラス
4 997337 080996



Package



Black tea
Model BY-0421BT
H.105 φ100mm
オイル容量 10ml
¥2,700+税
材質：水晶、ラブラドライト、ガラス
4 997337 081047



Package



White sandalwood
Model BY-0421WSW
H.105 φ100mm
オイル容量 10ml
¥2,700+税
材質：水晶、ソーダライト、ガラス
4 997337 081054



Package

Fragrance tester 各香りの店頭展示サンプルをご用意しています。ご希望の方は営業担当までお問い合わせください。



Cactus fragrance diffuser 



Package

材質：石こう、ガラス
使用期間目安 約30日



A) Elegant peony
Model G675-824A-EP
H.150 φ90mm
容量 100ml
¥2,200+税

4 997337 682411



B) Ocean breeze
Model G675-824B-OB
H.147 φ90mm
容量 100ml
¥2,200+税

4 997337 682428



C) White flower
Model G675-824C-WF
H.132 φ90mm
容量 100ml
¥2,200+税

4 997337 682435



Package

材質：石こう、ガラス、白雲石
使用期間目安 約30日



Cactus fragrance diffuser Spring flower
Model G875-959-SF
H.160 φ90mm
100ml
¥2,800+税

4 997337 895910



Little gem fragrance diffuser Water lily
Model G875-959-WL
H.145 φ90mm
100ml
¥2,800+税

4 997337 896016



Aloe fragrance diffuser Cutting grass
Model G875-959-CG
H.155 φ90mm
100ml
¥2,800+税

4 997337 896115

Fragrance tester 各香りの店頭展示サンプルをご用意しています。ご希望の方は営業担当までお問い合わせください。

Aroma diffuser hydrangea

H.333 φ95mm
リード L.300mm×3pcs
容量 120ml
¥3,000+税
使用期間目安 約45日



Red Blackberry&Fennel
Model H19-0048RD
4 997337 059190



Rosy brown Rose garden
Model H19-0048BR
4 997337 059213



Green Black tea&Cardamon
Model H19-0048GN
4 997337 059220



Blue Citrus verbena
Model H19-0048BL
4 997337 059237

Aroma diffuser dahlia 450

H.320 φ112mm
リード L.300mm×3pcs
容量 450ml
¥4,200+税
使用期間目安 約5ヶ月



Red Rose garden
Model H19-0049RD
4 997337 059244



Purple English garden
Model H19-0049PL
4 997337 059268



Green Honeysuckle
Model H19-0049GN
4 997337 059275



Blue Black vanilla
Model H19-0049BL
4 997337 059282



Pink Blackberry&Fennel
Model H19-0049PK
4 997337 059299

Fragrance tester 各香りの店頭展示サンプルをご用意しています。ご希望の方は営業担当までお問い合わせください。



Iron candle stand

材質：アイアン、ガラス



S
Model H19-0110S
H.245 φ90mm
Holder φ45mm
¥2,300+税
4 997337 063418

L
Model H19-0110L
H.350 φ90mm
Holder φ45mm
¥2,400+税
4 997337 063425

Iron candle holder

材質：アイアン（電気メッキ）



Nickel M
Model H20-0298M/NC
H.180 φ55mm
Holder φ20mm
¥1,400+税
4 997337 074292

Nickel L
Model H20-0298L/NC
H.220 φ55mm
Holder φ20mm
¥1,500+税
4 997337 074308

◎製造工程上、表面にキズやスレが見られる場合がありますが使用上問題ありません。
◎ハンドメイドのため、表面加工や風合いサイズに個体差があります。製品の特性としてご理解ください。
◎キャンドルの形状によっては、ご使用できない場合があります。

Candle holder Glassball

材質：ガラス

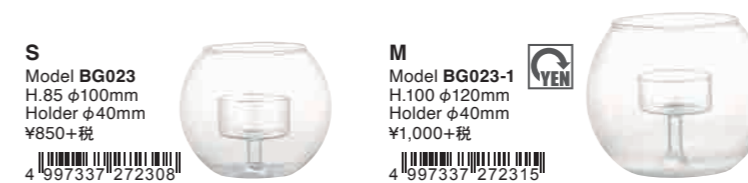

S
Model BG023
H.85 φ100mm
Holder φ40mm
¥850+税
4 997337 272308

M
Model BG023-1
H.100 φ120mm
Holder φ40mm
¥1,000+税
4 997337 272315

Glass candle holder

材質：ガラス



Model S95545S
H.140 W.85mm
Holder φ45mm
¥2,000+税
4 997337 554510

Model S95545M
H.180 W.85mm
Holder φ45mm
¥2,200+税
4 997337 554527





Birchwood log candle

材質：ワックス、バーチウッド、スチール



S
Model XR23-0579S
H.100 φ80mm
燃焼時間 約35時間
¥1,000+税
4 997337 087766



M
Model XR23-0579M
H.150 φ105mm
燃焼時間 約80時間
¥2,200+税
4 997337 087773



S
Model XR23-0580S
H.75 φ150mm
燃焼時間 約40時間
¥2,700+税
4 997337 087797

◎火を灯す際は、深さのある不燃性のキャンドルホルダーや耐熱性の皿等を敷いてご使用ください。
◎テーブルなど直に置き、火を灯さないようにご注意ください。◎白樺の樹皮の色味や黒い木目には個体差があります。

Birchwood led candle

材質：ワックス、バーチウッド、ABS樹脂

S
Model XR23-0585S
H.100 φ75mm
連続点灯時間 約200時間
¥1,600+税
4 997337 087988



M
Model XR23-0585M
H.150 φ75mm
連続点灯時間 約200時間
¥1,900+税
4 997337 087995



◎単4電池×3pcs使用。◎電池は付属しません。◎白樺の樹皮の色味や黒い木目には個体差があります。



Birchwood stump candle

材質：ワックス、バーチウッド



Glass Sound Expander

Model A555-532
H.260 W.133 D.135mm
¥6,200+税

4 997337 515016



Package

◎製造工程上、若干の歪みやスジ、大きさや重量に多少の個体差が生じる場合があります。あらかじめご了承ください。



Twisted string
Model GS555-266
H.105 W.150mm
100m/roll
¥500+税

材質：コットン35%
ポリエステル65%

◎ハンドメイドのため、色やサイズ等は製品によって異なります。製品の特性としてご理解ください。
◎力を入れて引っ張ると切れてしまいます。取扱いは十分ご注意ください。
◎濃い色の場合、色落ちする可能性があります。



White / Red
Model GS555-266A
4 997337 266017

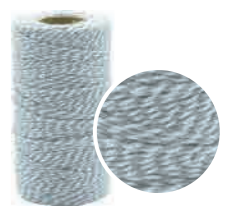

White / Gray
Model GS555-266F
4 997337 266062



White / Black
Model GS555-266G
4 997337 266079



White / Navy
Model GS555-266H
4 997337 082662

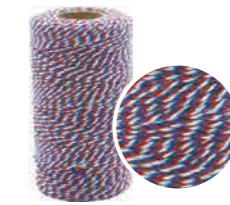

White / Blue / Red
Model GS555-266L
4 997337 266116



Yellow / Gray
Model GS555-266N
4 997337 266130



White / Green
Model GS555-266J
4 997337 092661



L.E.D lantern antique silver



Model R855-1043ASV
H.280 W.170 D.190mm
¥3,800+税
4 997337 804325



Model R855-1044ASV
H.300 W.145 D.160mm
¥3,800+税
4 997337 804424

◎アルカリ単3電池×2pcs使用 連続点灯時間(目安): 約96時間
◎電池は付属しません。

【L.E.D LANTERNについて】

◎付属のLED型電球は本製品専用の仕様です。破損や発火の恐れがあり大変危険ですので他の照明器具・電気製品には、絶対に接続しないでください。他の電球を本製品に接続する等も危険ですのでお止めください。
◎アンティークの風合いを出す為の加工(色ムラ・サビ加工・塗装はがれ等)が施されています。塗装の風合いに多少の個体差があります。
◎屋内用です。高温多湿な場所、火の側ではご使用にならないでください。
◎小さなお子様の手の届かない場所でご使用ください。



Cactus Type-D
Model K655-657D
H.355 W.215mm
¥3,800+税
材質：ポリレジン
4 997337 565745



Cactus Type-E
Model K655-657E
H.275 W.160mm
¥3,000+税
材質：ポリレジン
4 997337 565752



String holder
Model S355-99ABK
H.250 W.177 D.102mm
¥2,500+税
材質：アイアン
4 997337 935593

付属品 ハサミ、麻紐(約100m)
芯棒は2種類付属します。

◎アンティークの雰囲気を出す為の仕上げ(色ムラ・塗装剥げ・サビ)等が施されています。



Fishes

材質：表地／ポリエステル100%
中綿／ポリプロピレン100%



Pike 195

Model Y-0506
L.1950mm
¥12,000+税



Rainbow trout 70

Model Y-0509
L.700mm
¥2,500+税



Brown trout 70

Model Y-0510
L.700mm
¥2,500+税



Salmon 65

Model Y-0512
L.650mm
¥2,400+税



Zander 75

Model Y-0513
L.750mm
¥3,000+税



Perch 45

Model Y-0508
L.450mm
¥2,200+税



Pike 85

Model Y-0511
L.850mm
¥2,800+税



Halibut 105

Model Y-0507
L.1050mm
¥5,800+税



Brown crab 25

Model Y-0515
L.250mm
¥2,500+税



◎こちらの製品はストラップが付属しません。



European lobster 45

Model Y-0514
L.450mm
¥2,500+税



◎こちらの製品はストラップが付属しません。

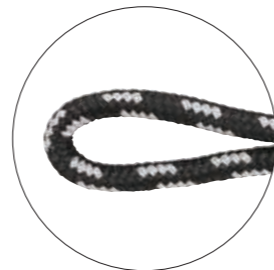

◎ロ元にストラップが付属します。
Y-0514・Y-0515には付属しません。





TABLE CLOTH
PICNIC RUG
BED COVER
TAPESTRY
AND MORE..

MULTI CLOTHES



Multi cloth
Model S159-54
1500×2250mm
¥1,500+税
材質：コットン



◎ハンドメイドのため、染色の際に生地が縮み、多少サイズに個体差があります。多少のムラ・糸のほつれ・糸飛び等があります。商品の特性としてご理解ください。
◎インド綿特有のニオイが気になる場合は、風通しの良い場所で陰干しすることにより解消されます。洗濯の際は、他の物と分けて洗ってください。



AA
4 997337 954297



AX
4 997337 954525

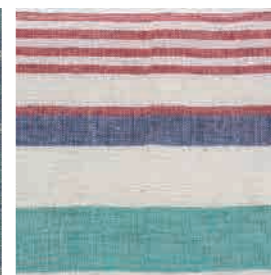

BA
4 997337 954556

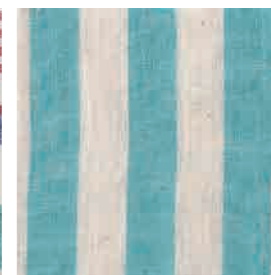

BH
4 997337 954624



CHBE
4 997337 087018



CHBL
4 997337 076593

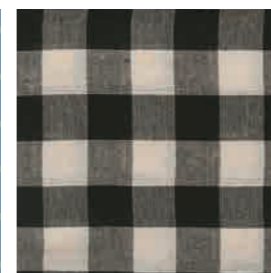

CHBW
4 997337 076548



CHGB
4 997337 086998



CHGN
4 997337 087001



CHLB
4 997337 076616



CHNB
4 997337 076630

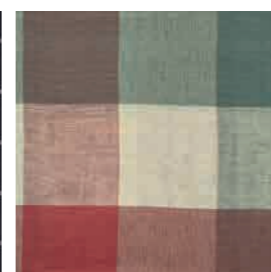

CHNR
4 997337 076647



CHNW
4 997337 076609



CHPK
4 997337 076555

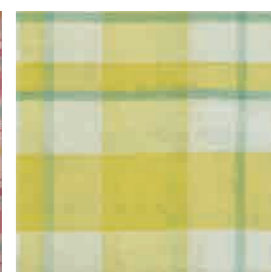

CHYE
4 997337 076531

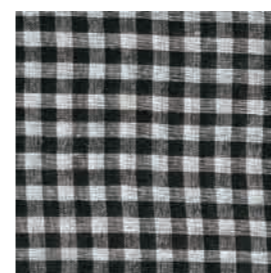

H
4 997337 954082



STBL
4 997337 076623

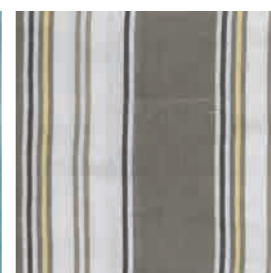

STKH
4 997337 086981

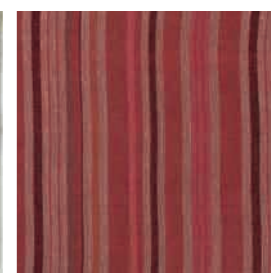

STRD
4 997337 076586



U
4 997337 954228

NEW ARRIVAL

CAR & OUTDOOR

FURNITURE

HOUSEWARE

GARDEN & GREEN

KITCHENWARE

SMALL SUNDRIES



Multi cloth "Solid color"

Model S359-36
1500×2250mm
¥1,400+税
材質:コットン

- ◎ハンドメイドのため、染色の際に生地が縮み、多少サイズに個体差があります。
- ◎多少のムラ・糸のほつれ・糸飛び等があります。
- ◎生産毎に色の濃淡や、材質の風合いに多少の個体差があります。商品の特性としてご理解ください。
- ◎インド綿特有のニオイが気になる場合は、風通しの良い場所で陰干しすることにより解消されます。
- ◎洗濯の際は、他の物と分けて洗ってください。



B) Green tea

4 997337 593625



C) Lavender

4 997337 593632

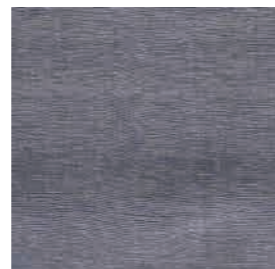

D) Midnight

4 997337 593649



E) Jelly

4 997337 593656



F) Sunbeam

4 997337 593663



G) Tan

4 997337 593670



H) Sand

4 997337 593687



L) Marine blue

4 997337 936118



N) Bamboo

4 997337 936132



Q) Steel gray

4 997337 936156



R) Seaport

4 997337 936163

Printed multi cloth

Model S459-234
1500×2250mm
¥2,400+税
材質:コットン

- ◎ハンドメイドのため、染色の際に生地が縮み、多少サイズに個体差があります。
- ◎多少のムラ・糸のほつれ・糸飛び等があります。
- ◎生産毎に色の濃淡や、材質の風合いに多少の個体差があります。商品の特性としてご理解ください。
- ◎インド綿特有のニオイが気になる場合は、風通しの良い場所で陰干しすることにより解消されます。
- ◎洗濯の際は、他の物と分けて洗ってください。



P03

4 997337 923439



P08

4 997337 923484



P11

4 997337 112345



P13

4 997337 132343



P17

4 997337 172349

Mexican throw

1750×1250mm
¥3,600+税
材質:コットン40%、ポリエステル60%



Blue
Model G21-0318BL

4 997337 075930



Orange
Model G21-0318OR

4 997337 075916



Pink
Model G21-0318PK

4 997337 075923



Navy blue
Model RN-0581NB

4 997337 087810



Dark green
Model RN-0581DG

4 997337 087827



- ◎ハンドメイドのため、生産毎にサイズの個体差があります。
- ◎多少のムラ・糸のほつれ・糸飛び等があります。
- ◎製品の特性としてご理解ください。





Acrylic blanket

Model K659-661
1300×2250mm
¥3,500+税

材質：アクリル 80%
ポリエステル 20%



バッグ付属



A

4 997337 166195

◎ハンドメイドのため、生産毎により色の濃淡や、
材質の風合いに多少の個体差があります。
製品の特性としてご理解ください。
◎材質の性質上、設置面等に色移りする場合があります。



B

4 997337 266192



C

4 997337 366199

Jacquard multi cloth

材質：ポリエステル85%、コットン15%

◎ハンドメイドのため、
サイズや色・織り方に多少の個体差があります。
糸のほつれや糸飛び等も生じる場合がありますが、
製品の特性としてご理解ください。
◎素材の特性上、洗濯時に色落ちや縮みがあります。
洗濯を重ねる度に色落ちは軽減されます。

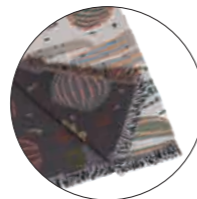

L 1350×1550mm

S 950×1430mm



Cactus

Model	Size	Price
S RN-0582S/CCTS	950×1430mm	¥4,500+税
L RN-0582L/CCTS	1350×1550mm	¥7,200+税



Native

Model	Size	Price
S RN-0582S/NATV	950×1430mm	¥4,500+税
L RN-0582L/NATV	1350×1550mm	¥7,200+税



Eden

Model	Size	Price
S RN-0582S/EDEN	950×1430mm	¥4,500+税
L RN-0582L/EDEN	1350×1550mm	¥7,200+税



Navajo

Model	Size	Price
S RN-0582S/NAVJ	950×1430mm	¥4,500+税
L RN-0582L/NAVJ	1350×1550mm	¥7,200+税





Cotton chindi mat / rug

材質：コットン65%、ポリエステル35%

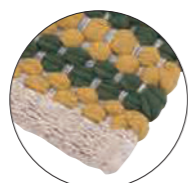

Green / Blue

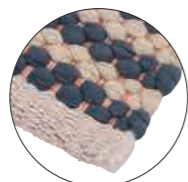

Terracotta / Navy



Green / Blue

	Model	Size	Price
Mat	RN-0529-75GB	500×750mm	¥2,700+税
Half rug	RN-0529-130GB	900×1300mm	¥8,500+税
Rug	RN-0529-190GB	1300×1900mm	¥17,000+税

Terracotta / Navy

	Model	Size	Price
Mat	RN-0529-75TN	500×750mm	¥2,700+税
Half rug	RN-0529-130TN	900×1300mm	¥8,500+税
Rug	RN-0529-190TN	1300×1900mm	¥17,000+税

Rug	1300×1900mm
Half rug	900×1300mm
Mat	500×750mm

Cotton rope mat / rug

材質：コットン100%

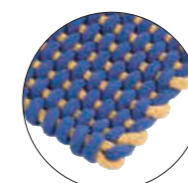

Blue

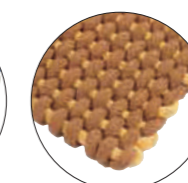

Brown

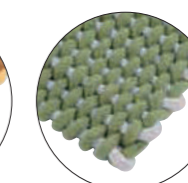

Green

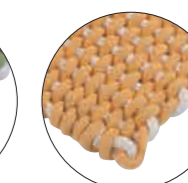

Yellow

Blue

	Model	Size	Price
Mat	RN-0528-75BL	500×750mm	¥4,500+税
Rug mat	RN-0528-130BL	800×1300mm	¥12,500+税

Brown

	Model	Size	Price
Mat	RN-0528-75BR	500×750mm	¥4,500+税
Rug mat	RN-0528-130BR	800×1300mm	¥12,500+税

Green

	Model	Size	Price
Mat	RN-0528-75GN	500×750mm	¥4,500+税
Rug mat	RN-0528-130GN	800×1300mm	¥12,500+税

Yellow

	Model	Size	Price
Mat	RN-0528-75YL	500×750mm	¥4,500+税
Rug mat	RN-0528-130YL	800×1300mm	¥12,500+税

◎ハンドメイドのため、サイズや色・織りに多少の個体差があります。製品の特性としてご理解ください。
◎ご家庭でのお洗濯はできません。手洗いや洗濯機洗いをを行うと色落ちや色移り、型崩れの原因となりますのでお避けください。濡れた場合はすぐに乾布で拭き取り、風通しの良い場所で陰干ししてください。

◎ハンドメイドのため、サイズや色・織りに多少の個体差があります。製品の特性としてご理解ください。◎素材の特性上、洗濯時に色落ちや縮みがあります。必ず手洗いで他のものと分けて洗ってください。◎綿素材の為、長時間水につけたままにしたり、水にぬれた状態でこすると色移りする場合があります。

Denim mat
 Model A659-601DBL
 500×750mm
 ¥2,000+税

材質：コットン100%

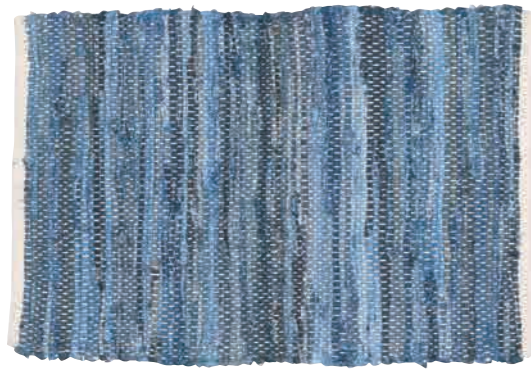
◎ハンドメイドのため、生産毎により色の濃淡や、材質の風合いに多少の個体差があります。製品の特性としてご理解ください。
 ◎材質の性質上、設置面等に色移りする場合があります。

Denim floor rug S
 Model A659-602DBL
 1000×1500mm
 ¥7,000+税

材質：コットン100%



PVC mat
 材質：ポリ塩化ビニル



Navy × Yellow

Model	Size	Price
S H19-0078S/NYL	H.10 400×600mm	¥1,800+税
M H19-0078M/NYL	H.10 500×700mm	¥2,500+税
L H19-0078L/NYL	H.10 600×900mm	¥3,500+税



Gray × Red

Model	Size	Price
S H19-0079S/GRD	H.10 400×600mm	¥1,800+税
M H19-0079M/GRD	H.10 500×700mm	¥2,500+税
L H19-0079L/GRD	H.10 600×900mm	¥3,500+税

PVC coil mat
 材質：ポリ塩化ビニル

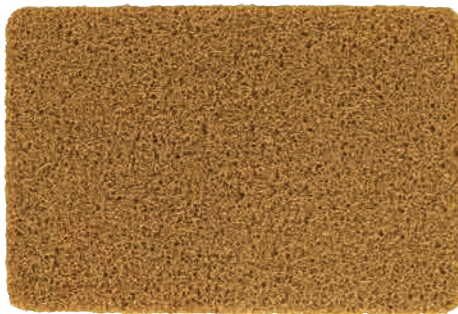

Mustard

Model	Size	Price
S H19-0080S/MS	H.12 400×600mm	¥2,000+税
M H19-0080M/MS	H.12 500×700mm	¥2,800+税
L H19-0080L/MS	H.12 600×900mm	¥3,900+税



Pinkish NEW

Model	Size	Price
S H19-0080S/PKS	H.12 400×600mm	¥2,000+税
M H19-0080M/PKS	H.12 500×700mm	¥2,800+税
L H19-0080L/PKS	H.12 600×900mm	¥3,900+税

S / 400×600mm

M / 500×700mm

L / 600×900mm

◎ハンドメイドのため、生産毎によりサイズや色の濃淡、材質の風合いに多少の個体差があります。製品の特性としてご理解ください。
 ◎材質の性質上、設置面等に色移りする場合があります。

Cotton handloom mat

材質：コットン100%



Blue × Yellow

Model	Size	Price
RN-0497-75BY	500×750mm	¥1,600+税
RN-0497-120BY	500×1200mm	¥2,600+税



Red

Model	Size	Price
RN-0497-75RD	500×750mm	¥1,600+税
RN-0497-120RD	500×1200mm	¥2,600+税



Green

Model	Size	Price
RN-0497-75GN	500×750mm	¥1,600+税
RN-0497-120GN	500×1200mm	¥2,600+税

500×750mm

500×1200mm

◎ハンドメイドのため、サイズや色の濃淡、材質の風合いに多少の個体差があります。製品の特性としてご理解ください。





Chenille handloom mat
 材質：パイル/ポリエステル100%、ベース/コットン100%



Gray

Model	Size	Price
RN-0496-60GY	400×600mm	¥2,000+税
RN-0496-75GY	500×750mm	¥3,000+税

Wine

Model	Size	Price
RN-0496-60WN	400×600mm	¥2,000+税
RN-0496-75WN	500×750mm	¥3,000+税

Yellow

Model	Size	Price
RN-0496-60YL	400×600mm	¥2,000+税
RN-0496-75YL	500×750mm	¥3,000+税

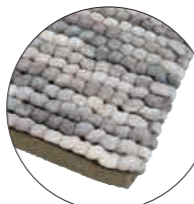

Gray

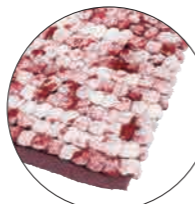

Wine



Yellow

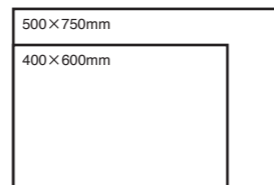

◎ハンドメイドのため、サイズや色の濃淡・材質の風合いに多少の個体差があります。製品の特性としてご理解ください。

Slippers combi

材質：ポリエステル100%、TPR樹脂、EVA樹脂



S) Woman H.90 W.270 D.115mm ¥1,500+税
 L) Men H.110 W.305 D.125mm ... ¥1,600+税

バッグ付属



Woman / Gray
 Model RN-0494S/GY
 4 997337 084932

Men / Gray
 Model RN-0494L/GY
 4 997337 084963



Woman / Green
 Model RN-0494S/GN
 4 997337 084949

Men / Green
 Model RN-0494L/GN
 4 997337 084970



Woman / Yellow
 Model RN-0494S/YL
 4 997337 084925

Men / Yellow
 Model RN-0494L/YL
 4 997337 084956

◎サイズや色の濃淡・材質の風合いに多少の個体差があります。製品の特性としてご理解ください。

Corduroy slippers EV

材質：ポリエステル、TPR樹脂



S) Woman H.90 W.270 D.110mm ¥1,500+税
 L) Men H.100 W.300 D.130mm ... ¥1,600+税



Woman / Beige
 Model T20-0224S/BE
 4 997337 069281

Men / Beige
 Model T20-0224L/BE
 4 997337 069366



Woman / Deep turquoise
 Model T20-0224S/TQ
 4 997337 069311

Men / Deep turquoise
 Model T20-0224L/TQ
 4 997337 069380



Woman / Green
 Model T20-0224S/GN
 4 997337 069328

Men / Green
 Model T20-0224L/GN
 4 997337 069397



Woman / Gray
 Model T20-0224S/GY
 4 997337 069335

Men / Gray
 Model T20-0224L/GY
 4 997337 069403



Woman / Camel
 Model T20-0224S/CAM
 4 997337 092913

Men / Camel
 Model T20-0224L/CAM
 4 997337 092906

バッグ付属



PU slippers EV

材質：ポリウレタン、TPR樹脂



S) Woman H.90 W.270 D.110mm ¥1,500+税
 L) Men H.100 W.300 D.130mm ... ¥1,600+税

バッグ付属



Woman / Navy
 Model T20-0226S/NB
 4 997337 069588

Men / Navy
 Model T20-0226L/NB
 4 997337 069595



Woman / Black
 Model T20-0226S/BK
 4 997337 070539

Men / Black
 Model T20-0226L/BK
 4 997337 070546



Woman / Brown
 Model T20-0226S/BR
 4 997337 070515

Men / Brown
 Model T20-0226L/BR
 4 997337 070522

KITCHENWARE

SMALL SUNDRIES



The DULPEDIA 2024

GARDEN & GREEN

Garden tool 246

Pot 256

Flower vase 266



Stainless pruner
材質：3CR13ステンレススチール



Model **G21-0384**
L.210 W.42mm
¥2,800+税
4 997337 079525

Pruning scissors
材質：3CR13ステンレススチール



S
Model **G21-0385S**
L.185 W.55mm
¥2,700+税
4 997337 079549



L
Model **G21-0385L**
L.220 W.50mm
¥2,800+税
4 997337 079532



Sharp Head Pruner
Model **K565-478**
L.200 W.55 D.18mm
¥2,500+税
材質：アッシュウッド、18-0ステンレススチール
4 997337 654784



Round Head Pruner
Model **K565-477**
L.190 W.50 D.18mm
¥2,500+税
材質：アッシュウッド、18-0ステンレススチール
4 997337 654777



ストッパー付

Garden tools



- 1) **Mini Trowel**
Model **CH14-G514**
H.185 W.47 D.30mm
¥500+税
4 997337 745147
- 2) **Hand Trowel**
Model **CH14-G510**
H.330 W.85 D.40mm
¥1,800+税
4 997337 745109
- 3) **Hand Scoop**
Model **CH14-G513**
H.330 W.90 D.40mm
¥2,000+税
4 997337 745130
- 4) **Hand Fork**
Model **CH14-G511**
H.285 W.84 D.45mm
¥1,800+税
4 997337 745116
- 5) **Mini Rake**
Model **CH14-G515**
H.162 W.42 D.30mm
¥500+税
4 997337 745154
- 6) **Trowel 225**
Model **K955-1219**
H.225 W.63 D.26mm
¥1,300+税
4 997337 952194
- 7) **Weeder round**
Model **K955-1223**
H.310 W.50 D.20mm
¥1,200+税
4 997337 952231
- 8) **Weeder square**
Model **K955-1224**
H.270 W.101 D.70mm
¥1,800+税
4 997337 122498
- 9) **Dibber**
Model **K955-1222**
H.296 W.102 D.35mm
¥1,200+税
4 997337 952224
- 10) **Blower & brush**
Model **K955-1215**
H.110 W.52 D.30mm
¥280+税
4 997337 121590

10)以外の材質：アッシュウッド、18-0ステンレススチール

Metal brush
Model **G21-0387**
L.210mm
¥900+税

材質：304ステンレススチール
ナイロン



Brush pen
Model **G21-0386**
L.190mm
¥600+税

材質：豚毛、フナ材



Botany stainless tool set
Model **NB-0607**
Scoop L.235mm
Tweezer L.190mm
¥1,800+税

材質：201ステンレススチール

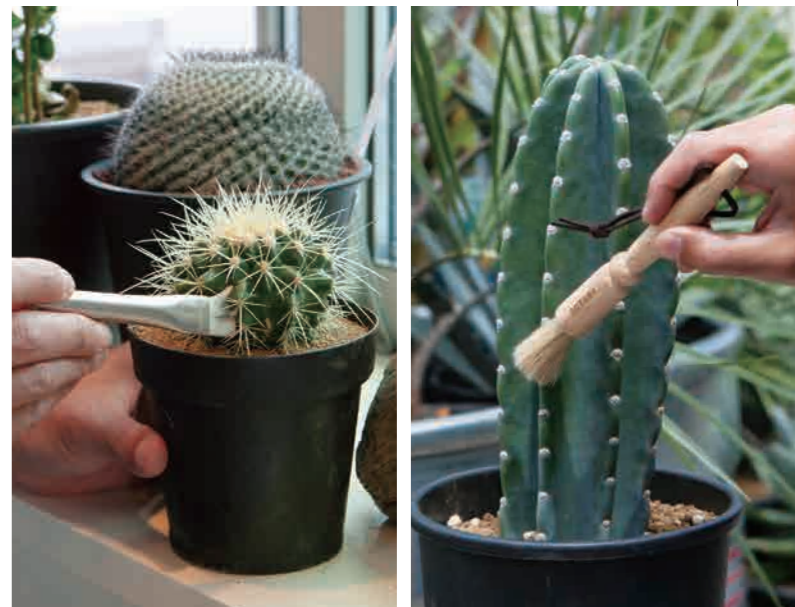



Plastic garden tools

材質：ABS樹脂



Plastic trowel
Model NB-0465
H.280 W.68 D.25mm
¥500+税



Plastic rake
Model NB-0466
H.270 W.74 D.26mm
¥500+税



Plastic weeding hoe
Model NB-0467
H.280 W.21 D.74mm
¥500+税



Plastic transplanter
Model NB-0468
H.280 W.48 D.25mm
¥500+税



Plastic weeder
Model NB-0469
H.275 φ26mm
¥500+税

BOTANY Work gloves

¥600+税

材質：ナイロン98%、エラストック2%
ニトリルゴム

S NEW
Model NBN-0492S
Hand length 225mm
Finger length 70mm
Hand circumference(手囲) 180mm
4 997337 093163

M
Model NBN-0492M
Hand length 245mm
Finger length 78mm
Hand circumference(手囲) 200mm
4 997337 084840

L
Model NBN-0492L
Hand length 270mm
Finger length 85mm
Hand circumference(手囲) 220mm
4 997337 084857



Left

Right

◎左右でプリントが異なります。



Package

Watering can 5L
 Model BYR-0416
 H.257 W.378 D.116mm
 ¥2,800+税
 材質：本体 / HDPE
 ハスロ / ポリプロピレン



High pressure garden hose
 Model NB-0458
 L.7.5m
 ¥6,200+税
 材質：ホース本体 / ラバー
 ホースカバー / ポリエステル, PVC
 シャワーヘッド / 亜鉛合金



Package



【セット内容】
 ホース×1、8ファンクションシャワーヘッド×1、コネクター×1、蛇口コネクター×1

◎蛇口コネクターは一般的な丸口蛇口に対応します。
 (蛇口の長さ20mm以上 / 蛇口外径14~18mm)

◎特殊形状やアンティーク蛇口にはお使いいただけません。



Leaf bag
 Model G21-0383
 H.740 W.650mm
 ¥2,700+税
 材質：本体 / ポリエステル
 ハンドル / PVC
 外枠 / PP



Circular bag
 材質：本体 / ポリエチレン
 ハンドル / ポリエステル
 底枠 / PVC



S
 Model G21-0390S
 H.350 W.350mm
 33L
 ¥1,300+税

L
 Model G21-0390L
 H.550 W.500mm
 108L
 ¥1,500+税

Branch bag
 Model G21-0388
 H.600 W.400mm
 ¥1,500+税
 材質：本体 / ポリエステル
 ハンドル / コットン
 内側 / PVCコーティング



BOTANY

NEW ARRIVAL

CAR & OUTDOOR

FURNITURE

HOUSEWARE

GARDEN & GREEN

KITCHENWARE

SMALL SUNDRIES



Repot sheet

材質：表面 / ターポリン
裏面 / ナイロン
スナップボタン / 銅

S
730×730mm
¥2,400+税

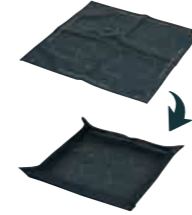

◎スナップボタンにより
角を留めることができます。

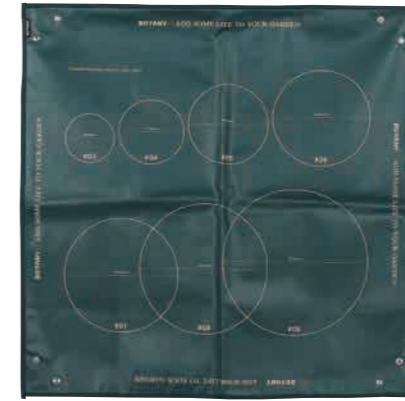

S / Green
Model G21-0389SGN
4 997337 079938

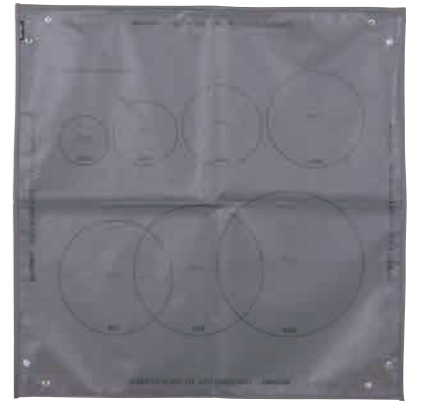

S / Gray
Model G21-0389SGY
4 997337 080798

L
1450×730mm
¥3,000+税

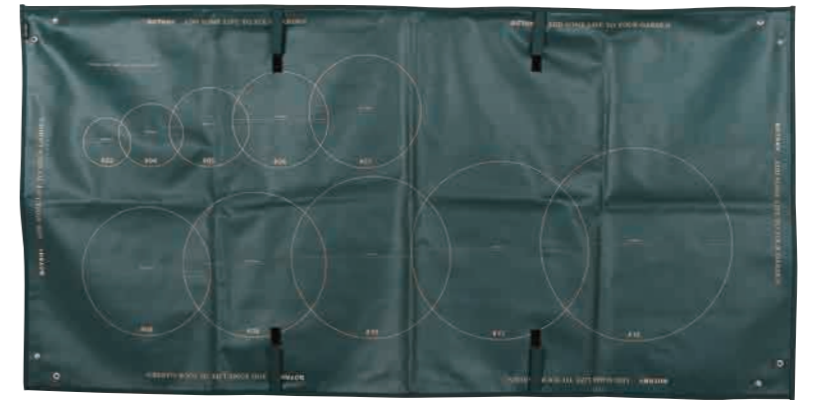
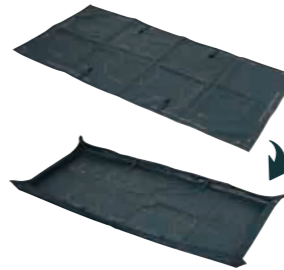

L / Green
Model G21-0389LGN
4 997337 079747

Iron boots brush

H.865 W.320 D.240mm
¥11,000+税



材質：土台 / アイアン
ハンドル / ニワウルシ
ブラシ / パルミラヤシ



Fork
Model NBR-0584
4 997337 087926

Shovel
Model NBR-0583
4 997337 087919



Soil bucket

材質：スチール、アルミニウム
付属品 アルミスコップ

S
Model G21-0380S/GV
H.300 W.340 D.240mm
16L
¥4,000+税
4 997337 079457



L
Model G21-0380L/GV
H.350 W.390 D.270mm
24L
¥5,000+税
4 997337 079464



Solar neon light

¥2,300+税

材質：本体 / ポリクリスタルシリコン、ABS樹脂、PP樹脂、HIPS、ラバー
スティック / 201ステンレススチール、PP樹脂

充電式ニッケル水素電池 1pc 付属



Package



Flamingo
Model NB-0543FL
H.735 W.130 D.12mm 4 997337 086905



Cactus
Model NB-0543CT
H.745 W.142 D.12mm 4 997337 086899



Pine
Model NB-0543PA
H.780 W.160 D.12mm 4 997337 086912



Palm tree
Model NB-0543PT
H.755 W.180 D.12mm 4 997337 086929

Little windmill

材質：Green / アイアン(ラッカー塗装、クリアラッカー仕上げ)
Galvanized / ガルバナイズドシート(クリアラッカー仕上げ)

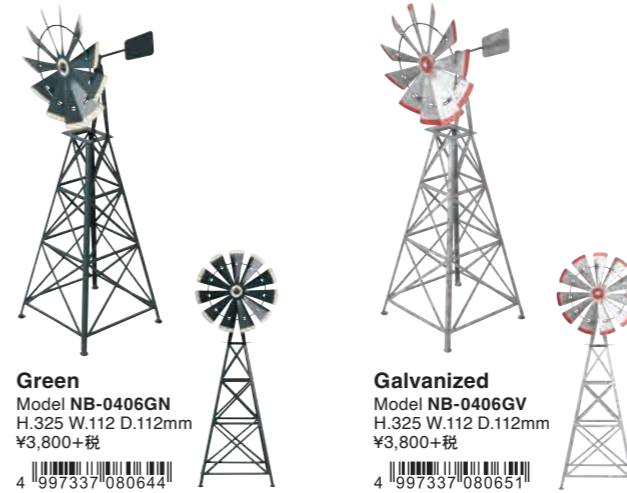

Green
Model NB-0406GN
H.325 W.112 D.112mm
¥3,800+税
4 997337 080644

Galvanized
Model NB-0406GV
H.325 W.112 D.112mm
¥3,800+税
4 997337 080651





This park is for your enjoyment, safety & pleasure, please be considerate of others & observe these rules:
 Dogs must be on leash. L.A.M.C. 83.44-8.2.1(c)
 Golfing prohibited. L.A.M.C. 83.44-8.7
 Alcoholic beverages prohibited. L.A.M.C. 83.41.27.1(c)
 Park closed from 10-30pm to 5-00am. No loitering. L.A.M.C. 83.44-8.14

Galvanized tank

材質：ガルバナイズドシート(クリアラッカー仕上げ)



S
 Model NBZ-0460S
 H.345 φ358mm
 Weight 約 4.4kg
 ¥8,000+税
 4 997337 083805



M
 Model NBZ-0460M
 H.450 φ422mm
 Weight 約 6.3kg
 ¥11,000+税
 4 997337 083812



L
 Model NBZ-0460L
 H.540 φ486mm
 Weight 約 8.4kg
 ¥14,000+税
 4 997337 083829



Aluminum pot with saucer

材質：アルミニウム(クリアラッカー仕上げ)
底穴1 受皿付



S
Model NB-0462S
H.112 φ105mm
¥2,400+税



M
Model NB-0462M
H.158 φ163mm
¥3,300+税



L
Model NB-0462L
H.197 φ202mm
¥4,300+税



Bottom

Aluminum saucer

材質：アルミニウム(クリアラッカー仕上げ)



S
Model NB-0461S
H.10 W.91 D.99mm
¥700+税



M
Model NB-0461M
H.12 W.123 D.132mm
¥800+税



L
Model NB-0461L
H.12 W.150 D.161mm
¥900+税



エンボスロゴ



BOTANY



Botany pot

材質：セラミック
底穴1 受皿付



3 / White
Model G21-0395XS/WT
H.83 φ90mm
¥800+税
LOT 4pcs



3 / Green
Model G21-0395XS/GR
H.83 φ90mm
¥800+税
LOT 4pcs



3 / Gray
Model G21-0395XS/GY
H.83 φ90mm
¥800+税
LOT 4pcs



3 / Beige
Model G21-0395XS/BE
H.83 φ90mm
¥800+税
LOT 4pcs



4 / White
Model G21-0395S/WT
H.113 φ120mm
¥1,200+税
LOT 4pcs



4 / Green
Model G21-0395S/GR
H.113 φ120mm
¥1,200+税
LOT 4pcs



4 / Gray
Model G21-0395S/GY
H.113 φ120mm
¥1,200+税
LOT 4pcs



4 / Beige
Model G21-0395S/BE
H.113 φ120mm
¥1,200+税
LOT 4pcs



5 / White
Model G21-0395M/WT
H.138 φ150mm
¥1,800+税



5 / Green
Model G21-0395M/GR
H.138 φ150mm
¥1,800+税



5 / Gray
Model G21-0395M/GY
H.138 φ150mm
¥1,800+税



5 / Beige
Model G21-0395M/BE
H.138 φ150mm
¥1,800+税



6 / White
Model G21-0395L/WT
H.165 φ180mm
¥2,400+税



6 / Green
Model G21-0395L/GR
H.165 φ180mm
¥2,400+税



6 / Gray
Model G21-0395L/GY
H.165 φ180mm
¥2,400+税



6 / Beige
Model G21-0395L/BE
H.165 φ180mm
¥2,400+税

HOUSEWARE

GARDEN & GREEN

KITCHENWARE

SMALL SUNDRIES

Botany long pot

材質：セラミック



S / White
Model NB-0602S/WT
H.164 φ146mm
¥1,800+税



S / Green
Model NB-0602S/GN
H.164 φ146mm
¥1,800+税



S / Gray
Model NB-0602S/GY
H.164 φ146mm
¥1,800+税



S / Beige
Model NB-0602S/BE
H.164 φ146mm
¥1,800+税



Bottom



L / White
Model NB-0602L/WT
H.184 φ187mm
¥2,800+税



L / Green
Model NB-0602L/GN
H.184 φ187mm
¥2,800+税



L / Gray
Model NB-0602L/GY
H.184 φ187mm
¥2,800+税



L / Beige
Model NB-0602L/BE
H.184 φ187mm
¥2,800+税



ADD SOME LIFE TO YOUR GARDEN

BOTANY

Color glazed pot

材質：テラコッタ



Model CH15-G527 鉢サイズ：2号鉢目安
H.95 φ105mm
Saucer H.18 φ100mm
¥850+税

Color	
Ivory	4 997337 552714
Yellow	4 997337 552738
Clay	4 997337 552783
Violet	4 997337 552707
Classic green	4 997337 552769
Light purple	4 997337 552790
Midnight blue	4 997337 552752
Orange	4 997337 552721
Turquoise	4 997337 552745
Lime green	4 997337 552776



Model CH13-G476 鉢サイズ：3号鉢目安
H.110 φ120mm
Saucer H.22 φ125mm
¥1,000+税

Color	
Ivory	4 997337 347617
Yellow	4 997337 347631
Clay	4 997337 347686
Violet	4 997337 347600
Classic green	4 997337 347662
Light purple	4 997337 347693
Midnight blue	4 997337 347655
Orange	4 997337 347624
Turquoise	4 997337 347648
Lime green	4 997337 347679



Model CH14-G516 鉢サイズ：4号鉢目安
H.155 φ160mm
底穴1 受皿なし
¥1,400+税

Color	
Ivory	4 997337 451611
Yellow	4 997337 451642
Clay	4 997337 451680
Violet	4 997337 451604
Classic green	4 997337 451659
Light purple	4 997337 451697
Midnight blue	4 997337 451664
Orange	4 997337 451673
Turquoise	4 997337 451635
Lime green	4 997337 451628

◎CH14-G516の受皿は別売りです。



Color glazed Saucer
Model CH14-G517
H.25 φ160mm
¥400+税



Ivory Yellow Clay Violet Classic Green



Light Purple Midnight Blue Orange Turquoise Lime Green

Glazed pot Round

Model K655-851



底穴1 受皿付



S / White
H.110 φ140mm
¥1,400+税



M / White
H.140 φ170mm
¥1,800+税



L / White
H.170 φ200mm
¥2,700+税



Glazed jug white
Model K655-852WT
H.180 W.140 D.170mm
¥1,800+税
底穴なし



◎こちらのページの製品はハンドメイドのため、形・サイズ・焼き色等に個体差があります。
◎表面のキズ、ピンホールや素地部分等にヒビが生じている場合があります。
◎釉薬のかかり方によって色むらがあったり、焼いている最中にできた細かなヒビ(貫入)や歪みが見られる場合がありますが使用上問題ありません。製品の特性としてご理解ください。



NEW ARRIVAL

CAR & OUTDOOR

FURNITURE

HOUSEWARE



Color glazed pot cover

H.65 φ80mm
¥300+税
材質：テラコッタ
底穴なし 受皿なし
LOT 6pcs



Ivory
Model G21-0394IV
4 997337 079853

Yellow
Model G21-0394YL
4 997337 079921



Clay
Model G21-0394CY
4 997337 079846

Violet
Model G21-0394VL
4 997337 079914

Classic green
Model G21-0394CGN
4 997337 079839

Light purple
Model G21-0394LPL
4 997337 079877



Midnight blue
Model G21-0394MBL
4 997337 079884

Orange
Model G21-0394OR
4 997337 079891

Turquoise
Model G21-0394TQ
4 997337 079907

Lime green
Model G21-0394LGN
4 997337 079860

◎ハンドメイドのため、形、サイズ、風合いや色等に個体差があります。
歪みや表面のキズ、ピンホール見られる場合もあります。製品の特性としてご理解ください。

Round pot

材質：テラコッタ
底穴1 受皿付

S

H.100 φ105mm
¥1,600+税

M

H.140 φ150mm
¥2,200+税



S / Bronze
Model G20-0196S/BZ
4 997337 068246

S / Gold
Model G20-0196S/GD
4 997337 068413

S / Silver
Model G20-0196S/SV
4 997337 068406

M / Bronze
Model G20-0196M/BZ
4 997337 068239

M / Gold
Model G20-0196M/GD
4 997337 068451

M / Silver
Model G20-0196M/SV
4 997337 068444

Silver pot with legs

材質：ストーンウェア
底穴なし 受皿なし



XS
Model G20-0203XS
H.85 φ75mm
¥900+税
4 997337 068420

S
Model G20-0203S
H.100 φ100mm
¥1,100+税
4 997337 068437

Terracotta bicolor pot

材質：テラコッタ
底穴1 受皿付



XS
Model G20-0202XS
H.90 φ95mm
¥1,200+税
4 997337 068383

S
Model G20-0202S
H.110 φ120mm
¥1,600+税
4 997337 068390

M
Model G20-0195M
H.150 φ160mm
¥2,200+税
4 997337 068215

L
Model G20-0195L
H.160 φ180mm
¥2,700+税
4 997337 068222

Ceramic pot

底穴1
ポットとソーサー 一体型



8 Green
Model G19-0006S/GN
H.80 φ90mm
¥550+税
4 997337 006552

8 Red
Model G19-0006S/RD
H.80 φ90mm
¥550+税
4 997337 006521

8 Yellow
Model G19-0006S/YL
H.80 φ90mm
¥550+税
4 997337 006545



Cement pot

材質：セメント
底穴1 受皿付

Oval

Model G20-0216
H.50 W.110 D.110mm
¥850+税
4 997337 068970



Round XS
Model G20-0220XS
H.70 φ80mm
¥900+税
4 997337 069038



Round S
Model G20-0219S
H.80 φ90mm
¥1,000+税
4 997337 069014



Round M
Model G20-0219M
H.100 φ120mm
¥1,500+税
4 997337 069021



Polyhedron

Model G20-0213
H.80 W.100 D.100mm
¥850+税
4 997337 068949



Trapezoid

Model G20-0214
H.80 W.80 D.80mm
¥750+税
4 997337 068956



Triangle

Model G20-0215
H.70 W.90 D.100mm
¥750+税
4 997337 068963



Pentagon

Model G20-0217
H.70 W.110 D.110mm
¥850+税
4 997337 068987



Solid planter cube

材質：コンクリート
底穴1 受皿付



S

Model A655-758S
H.102 W.110 D.110mm
Saucer H.20 W.110 D.110mm
¥1,600+税
鉢サイズ：2.5～3号鉢目安

Color
● Plain 4 997337 758130
● Rough gray 4 997337 758116



L

Model A655-758L
H.135 W.140 D.140mm
Saucer H.20 W.140 D.140mm
¥1,600+税
鉢サイズ：3.5～4号鉢目安
◎サボテンは付属しません。

Color
● Plain 4 997337 758338
● Rough gray 4 997337 758314

Solid planter rectangle

材質：コンクリート
底穴2



S

Model A555-426S
H.80 W.200 D.100mm
Saucer H.20 W.195 D.100mm
¥1,200+税

Color
● Plain 4 997337 426718
● Rough gray 4 997337 426916

L

Model A555-426L
H.80 W.240 D.100mm
Saucer H.20 W.240 D.100mm
¥1,500+税

Color
● Plain 4 997337 426732
● Rough gray 4 997337 426930

◎形、サイズ、風合いや色に個体差があります。
◎歪みや表面のキズ、ピンホール、底穴周りのヒビが生じている場合があります。製品の特性としてご理解ください。
◎セメントに水が沁み込み、設置箇所が濡れる恐れがあります。設置場所にはご注意ください。



Galvanized hanging pot cover



10
Model K865-1094-10
H.210 D.105mm
¥1,000+税
4 997337 809412

15
Model K865-1094-15
H.310 D.150mm
¥1,200+税
4 997337 809429

Flower basket long

材質：スチール



S
Model G19-0073S
H.300 W.235 φ195mm
¥1,900+税
4 997337 060141



M
Model G19-0073M
H.415 W.270 φ225mm
¥2,700+税
4 997337 060165



L
Model G19-0073L
H.470 W.312 φ260mm
¥3,400+税
4 997337 060172



©G19-0073は鉢カバーです。切花用のフラワーベースではありません。簡易防水処理を施しておりますが、溶接部分から若干の滲みや水漏れする場合がありますため、水が溜まった状態で長時間放置しないでください。

Galvanized pot cover



15
Model K865-1095-15
H.140 φ155mm
¥1,200+税
4 997337 809559



18
Model K865-1095-18
H.150 φ185mm
¥1,500+税
4 997337 809542



22
Model K865-1095-22
H.220 φ220mm
¥1,800+税
4 997337 809511



26
Model K865-1095-26
H.260 φ260mm
¥2,200+税
4 997337 809528



30
Model K865-1095-30
H.350 φ300mm
¥2,800+税
4 997337 809535

Galvanized round tray

材質：スチール



XS
Model G19-0076XS
H.15 φ132mm
¥700+税
LOT 6pcs
4 997337 060257



S
Model G19-0076S
H.15 φ203mm
¥900+税
LOT 6pcs
4 997337 060271



M
Model G19-0076M
H.15 φ250mm
¥1,300+税
LOT 6pcs
4 997337 060288



L
Model G19-0076L
H.20 φ350mm
¥1,600+税
LOT 3pcs
4 997337 060295

Aluminum scoop



S
Model CH14-K492S
L.180 W.58mm
¥1,000+税
4 997337 449212



M
Model CH14-K492M
L.210 W.80mm
¥1,300+税
4 997337 449229



L
Model CH14-K492L
L.260 W.97mm
¥1,600+税
4 997337 449236



Stainless pitcher

材質：201 ステンレススチール



Silver
Model G19-0083SV
H.94 W.174 D.75mm
270ml
¥2,200+税
4 997337 061667



Black
Model G19-0083BK
H.94 W.174 D.75mm
270ml
¥3,200+税
4 997337 061643



Gold
Model G19-0083GD
H.94 W.174 D.75mm
270ml
¥3,200+税
4 997337 061650

Stainless drip / water pot 650ml

⇒このシリーズのその他の製品はP39に掲載されています。

Model R815-1006-65
H.120 W.210 D.90mm
適正容量 500ml
¥2,500+税
4 997337 856652





Glass Vase "Probeta"

Glass Vase "Constricción"

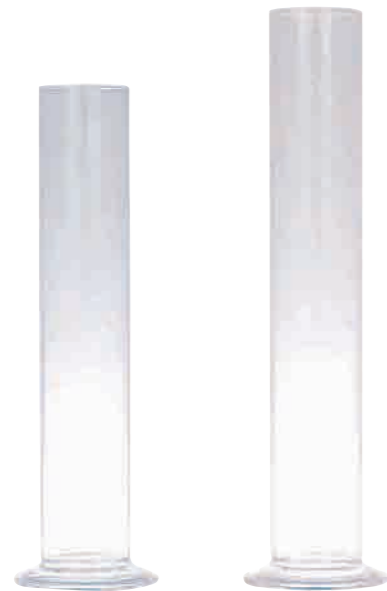

Model CK103
H.350 φ100mm
口径 60mm
¥1,500+税
4 997337 710305

Model CK103-40
H.400 φ100mm
口径 60mm
¥1,800+税
4 997337 710343



Model CK1878
H.255 φ140mm
口径 60mm
¥2,300+税
4 997337 187800

Model CK1878-30
H.305 φ165mm
¥3,200+税
4 997337 187831



Glass Vase "Bola plana"



Model CK1474-3
H.70 φ200mm
¥1,800+税
4 997337 314749



Model CK1474-2
H.100 φ300mm
¥3,600+税
4 997337 214742

Glass vase "Diamond"



Model G855-1071S
H.300 φ170mm
口径 100mm
¥3,300+税
4 997337 857116



Model G855-1070S
H.300 φ130mm
口径 120mm
¥3,300+税
4 997337 857017



Model G855-1070M
H.400 φ130mm
口径 120mm
¥3,800+税
4 997337 857024



Lunar vase



S
Model K865-1031S
H.140 φ70mm
¥1,800+税
4 997337 863117



M
Model K865-1031M
H.200 φ70mm
¥2,100+税
4 997337 863124

Link tube vase ◎付属の専用ブラシで手入れが可能です。

H.150 W.65~310 D.35mm
Glass H.150 φ25mm / each
¥2,200+税
材質：ガラス



Gold
Model CH03-V76GD 4 997337 037631



Silver
Model CH03-V76SV 4 997337 037600



Enameled flower vase 

材質：エナメル、アイアン



Monitor / Black
Model H21-0309BK
H.90 φ120mm
¥1,200+税
4 997337 075275



Monitor / Natural
Model H21-0309NT
H.90 φ120mm
¥1,200+税
4 997337 075282



Mansard / Black
Model H21-0311BK
H.112 φ150mm
¥1,600+税
4 997337 075312



Mansard / Natural
Model H21-0311NT
H.112 φ150mm
¥1,600+税
4 997337 075329



Curve / Black
Model H21-0313BK
H.185 φ140mm
¥1,800+税
4 997337 075350

◎製造工程上、サイズや形状、色みや色ムラ等、多少の個体差が生じる場合があります。製品の特性としてご理解ください。
◎成型時の取出し跡やピンホール、釉薬がのりにくい端部があります。この箇所はサビが生じやすいのでごまめに乾燥させてください。



Vase 

Model SGJ67
H.245 W.120mm
¥2,100+税
材質：セラミック



Ivory
4 997337 867016



Yellow
4 997337 867030



Blue
4 997337 867054



Green
4 997337 867061



Mocha
4 997337 867085

◎ハンドメイドのため、形・サイズ・焼き色等に個体差があります。
◎表面のキズ・ピンホールや素地部分・底穴周りにヒビが生じている場合があります。
◎釉薬の掛かり方によって色ムラがあったり、焼いている最中にできた細かなヒビ(貫入)や歪みが見られる場合がありますが使用上問題ありません。製品の特性としてご理解ください。



Flower bag 

H.500 W.290 D.30mm
¥2,300+税
材質：コットン100% (ワックス加工)、PVC、ジंकアロイ



Natural
Model H20-0299NT
4 997337 074315



Camel
Model H20-0299CAM
4 997337 074322

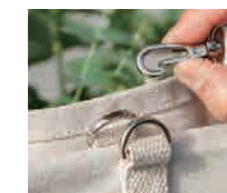

二つ折りにし、ショルダーストラップで2つのDカンを留めれば短いブーケや植木鉢も持ち運びやすいサイズになります。





The DULPEDIA 2024

KITCHENWARE

Kitchen Tool 272

Tableware 286

Diet scale



Model 100-126
H.160 W.95mm
Tray φ120mm
Capacity 500g
¥3,400+税

材質：本体/スチール
トレイ/ステンレススチール

Color	Barcode
Ivory	4 997337 126014
Red	4 997337 126021
Yellow	4 997337 126038
Sax	4 997337 126045
Mint green	4 997337 126076
Black	4 997337 126007
H.gray	4 997337 076678



Ivory



Red



Yellow

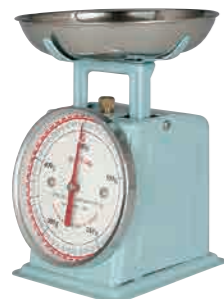

Sax



Mint green



Black



H.gray

American kitchen scale



Model 100-061
H.225 W.132mm
Tray φ175mm
Capacity 1kg
¥4,500+税

材質：本体/スチール
トレイ/ステンレススチール

Color	Barcode
Ivory	4 997337 100663
Red	4 997337 100632
Yellow	4 997337 100656
Sax	4 997337 100649
Black	4 997337 101615
H.gray	4 997337 076654



Ivory



Red



Yellow



Sax



Black



H.gray

Classic-gentle scale

Model 118-342
H.175 W.170 D.95mm
Tray φ190mm
Capacity 2kg
¥4,200+税

材質：本体/スチール
トレイ/アルミニウム



Side

Back

Color	Barcode
Ivory	4 997337 085908
Red	4 997337 085939
Yellow	4 997337 085946
Olive drab	4 997337 085922
Navy	4 997337 085915
Gray green	4 997337 085892



Ivory



Red



Yellow



Olive drab



Navy



Gray green



Color kitchen timer with magnet

Model 100-189
H.30 φ70mm
55min timer
材質：スチール、ポリカーボネート



Color	
● Chrome	¥1,800+税
● Ivory	¥1,800+税
● Red	¥1,800+税
● Yellow	¥1,800+税
● Sax	¥1,500+税
● Mint green	¥1,500+税
● Black	¥1,500+税
● H.gray	¥1,500+税
● Olive drab	¥1,500+税

◎構造仕様の調整等によりタイマー音や製品サイズに多少の個体差が生じます。



Aluminum trivet

Model 100-017
φ180mm
¥1,600+税



SS extensible trivet

Model K21-0363
H.78 W.176~410mm D.205mm
¥3,200+税
材質：18-8ステンレススチール

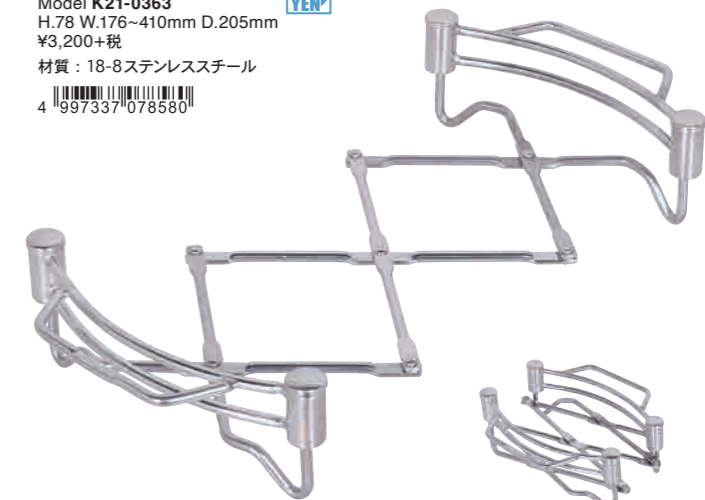

◎使用目安：鍋φ15~30cm対応
◎ハンドルは製品を伸縮するためのものです。持ち運び用のハンドルではありません。

Aluminum wishbone rack

Model M-0445
H.92 W.245 D.125mm
Weight 約430g
幅間隔 約23mm
¥2,200+税



材質：アルミニウム合金

4 997337 083225



◎表面は特殊なヴィンテージ加工を施しており、仕上げは個体差があります。加工の特性で拭き取り等の摩擦により多少の色付着が見られます。強く擦らないようご注意ください。

Tissue dispenser

Model 100-160N
H.145 W.260 D.125mm
Inside H.100 W.240 D.110mm
Weight 1.2kg
材質：スチール



Color	
● Vibration	¥6,900+税
● Stainless	¥6,800+税
● Ivory	¥3,600+税
● Red	¥3,600+税
● Yellow	¥3,600+税
● Sax	¥3,600+税
● H.gray	¥3,600+税
● Olive	¥3,600+税



for your convenience

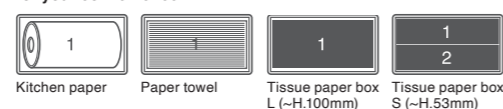

Kitchen paper Paper towel Tissue paper box L (~H.100mm) Tissue paper box S (~H.53mm)



Olive

Vibration

◎付属のラバースタンドを使用する事で、置き型のディスペンサーとしても使用可能です。



Iron trivet oblong

材質：アイアン (クリアラッカー)、ゴム



S
Model K21-0308S
H.20 W.95 D.125mm
¥700+税



M
Model K21-0308M
H.20 W.95 D.155mm
¥900+税



L
Model K21-0308L
H.20 W.125 D.180mm
¥1,000+税



Round trivet
Model S315-113ABK
H.15 150×150mm
¥900+税



Oval trivet
Model S315-114ABK
H.15 240×180mm
¥1,200+税



Rectangle trivet
Model S315-115ABK
H.18 250×170mm
¥1,500+税



Single ceramic ladle stand

Model CH01-K13
H.180mm
Tray φ108mm
¥900+税



Stainless steel bowl

材質：18-8ステンレススチール、シリコンゴム



S
Model K915-1244S
H.105 W.176 D.168mm
1L
¥2,000+税



M
Model K915-1244M
H.120 W.216 D.205mm
2.5L
¥2,500+税



L
Model K915-1244L
H.142 W.257 D.245mm
4.5L
¥3,200+税



2 in 1 jumbo funnel with strainer



Model K21-0342
H.140 W.165 D.142mm
Jumbo funnel H.70 W.165 φ142mm (Stem φ58mm)
Small funnel H.78 φ60mm (Stem φ12mm)
Strainer H.65 φ55mm
¥1,800+税

材質：18-8ステンレススチール



Aluminum bread tray

Model 9121
H.35 W.220 D.150mm
¥1,500+税



Aluminum tray

Model S81533
240×100mm
¥1,300+税



Aluminum tray

Model S115-12
H.11 W.300 D.110mm
¥1,100+税





Aluminum fish measuring spoon



Flour

Model 100-029F
L.150 W.50mm 15ml
¥600+税



Coffee

Model 100-029C
L.135 W.45mm 10ml
¥550+税



Tea

Model 100-029T
L.120 W.40mm 7ml
¥480+税



Sugar

Model 100-029SG
L.100 W.35mm 5ml
¥450+税



Salt

Model 100-029SL
L.90 W.30mm 2ml
¥420+税



Aluminum fish measuring spoon set



Model 100-029
L.180 W.230mm
¥3,200+税



Stainless measuring spoon set of 5



Model 100-104
L.123~143mm
1ml, 1.25ml, 3ml, 5ml, 10ml
¥1,700+税



SS measuring scoop set of 6

Model K20-0164
L.128~167mm
0.63ml, 1.25ml, 2.5ml, 3.75ml, 5ml, 15ml
¥1,700+税

材質：18-8 ステンレススチール



◎本体刻印の容量表記は"ML"から"mL"になります。

Mini kitchen tool set



材質：18-8ステンレススチール

Model 45710

Ladle: L.60mm Spoon: L.75mm
Skimmer: L.80mm
Slotted turner: L.90mm
Whisk: L.100mm
¥1,400+税



Tiny kitchen tool



材質：18-8ステンレススチール

Coffee / Satin

Model K20-0167COS
Stencil: L.37mm Filter: L.37mm
Scoop: L.54mm
¥1,100+税



◎SCOOPのハンドルに"1.50mL"の刻印が入ります。

Cutlery / Satin

Model K20-0167CUS
Knife: L.70mm Fork: L.70mm
Spoon: L.70mm
¥1,050+税



Aluminum ceiling rack



Model K21-0393
H.150 W.910 D.38mm
吊るし連結フックを除く
Weight 約1.5kg
フック×4pcs 可動フック×2pcs
¥7,800+税

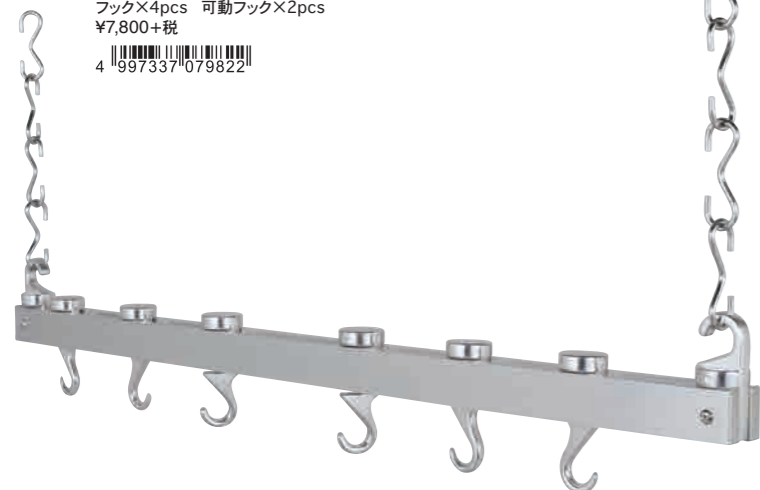

Top



フック×4pcs



可動フック×2pcs



Duralex measuring jug

材質：耐熱ガラス(耐熱温度差120℃)

[LOT]は予告なく変更する場合があります。詳しくは担当者までお問い合わせください。



500ml

Model 5016A-M06
H.120 W.165 D.120mm
¥3,250+税



1000ml

Model 5017A-M06
H.110 W.210 D.157mm
¥3,900+税



◎食器洗浄機の使用はできません。◎電子レンジ使用可能。
◎ガラス成形時のカット跡や波打ち線等が見られる場合があります。製品の特性としてご理解ください。



Measureglass



H.148 φ91mm
560ml
¥2,140+税

材質：ソーダガラス

LOT 12pcs

[LOT]は予告なく変更する場合があります。詳しくは担当者までお問い合わせください。

Measureglass A

Model N5004



Measureglass B

Model N5005



PP cutting board

材質：ポリプロピレン・シリコンゴム
 耐熱温度 110度
 耐冷温度 -20度
 電子レンジ・オーブン使用不可



Package

S
 H.8 W.300 D.200mm
 ¥1,500+税



S / Black
 Model Y915-1253S 4 997337 925310

M
 H.8 W.350 D.240mm
 ¥1,800+税



M / Black
 Model Y915-1253M 4 997337 925327

L
 H.11 W.405 D.285mm
 ¥2,500+税



L / Black
 Model Y915-1253L 4 997337 925334



Package

S / Olive
 Model Y915-1253S/OV 4 997337 086950



M / Olive
 Model Y915-1253M/OV 4 997337 086967



L / Olive
 Model Y915-1253L/OV 4 997337 086974



Oil & vinegar bottle

材質：ボトル/ホウケイ酸ガラス
 フタ/18-8ステンレススチール、ポリプロピレン
 パッキン/シリコンゴム
 耐熱温度差 120℃



350ml
 Model R615-738S
 H.188 W.105 D.65mm
 ¥2,300+税
 4 997337 083409



500ml
 Model R615-738
 H.230 W.105 D.65mm
 ¥2,500+税
 4 997337 657389

◎製造工程上、サイズや形状に若干の個体差があります。



Spice jar with spoon

Model R615-737
 H.117 W.115 D.80mm 300ml
 スプーン L.100mm
 ¥2,400+税

材質：18-8ステンレススチール
 ホウケイ酸ガラス(耐熱温度差 120℃)
 ABS樹脂
 スプーン/18-8ステンレススチール

4 997337 657372



Cube jar with press lid
材質：ソーダガラス



S
Model K915-1285S
H.135 W.97 D.97mm 550ml
¥2,000+税
4 997337 006163

M
Model K915-1285M
H.185 W.97 D.97mm 950ml
¥2,300+税
4 997337 006132

L
Model K915-1285L
H.333 W.97 D.97mm 2L
¥2,800+税
4 997337 006125

Cylinder jar with press lid
材質：耐熱ガラス（耐熱温度差120℃）



S
Model K915-1286S
H.97 φ100mm 350ml
¥2,000+税
4 997337 006194

M
Model K915-1286M
H.180 φ100mm 950ml
¥2,400+税
4 997337 006187

L
Model K915-1286L
H.295 φ100mm 1.8L
¥2,800+税
4 997337 006170

Stainless jar with press lid
材質：18-8ステンレススチール
ABS樹脂、シリコーンゴム



S
Model M-0436S
H.86 φ118mm
約350ml
¥2,200+税
4 997337 082983

M
Model M-0436M
H.159 φ118mm
約900ml
¥2,600+税
4 997337 082990

L
Model M-0436L
H.241 φ118mm
約1500ml
¥3,000+税
4 997337 083003

◎ 固形食品の保存容器として設計しています。
◎ ステンレス容器は塩類の含まれる食品の長期保存には適しません。



Cube spice jar
材質：201ステンレススチール
ソーダガラス、ABS樹脂



Model K20-0125
H.110 45×45mm
80ml
¥900+税
4 997337 063852

Model K20-0125/2
H.140 W.113 D.52mm
80ml×2pcs
¥2,200+税
4 997337 063869

Curved spice jar
材質：201ステンレススチール
ソーダガラス、ABS樹脂
シリコーンゴム



Model K20-0126
H.120 φ55mm
90ml
¥900+税
4 997337 063876

Model K20-0126/6
H.171 φ175mm
90ml×6pcs
¥5,000+税
4 997337 063906

Spice jar with rotation lid
Model K915-1287
H.125 φ55mm 130ml
¥1,000+税
材質：201ステンレススチール
ソーダガラス、ABS樹脂



6 bottles spice rack
Model CH01-K14
H.150 W.180 D.150mm
Bottle 75ml
¥1,800+税
4 997337 201148



Bottle for spice rack
Model CH01-K14B
¥250+税
LOT 3pcs
4 997337 011426

Glass canister screw lid
材質：ガラス、ステンレス、PP



Model CH02-K32S
H.150 W.115mm 0.9L
口径φ90mm
¥1,200+税
4 997337 232012

Model CH02-K32M
H.195 W.115mm 1.5L
口径φ90mm
¥1,300+税
4 997337 232029

Model CH02-K32L
H.250 W.115mm 1.8L
口径φ90mm
¥1,400+税
4 997337 232036



Carrebowl
Tempered glass



300ml
Model N9020
H.46 W.111 D.111mm
フタ取付時サイズ
H.48 W.113 D.113mm
¥890+税
LOT 12pcs
4 997337 894081



610ml
Model N9021
H.57 W.140 D.140mm
フタ取付時サイズ
H.58 W.142 D.142mm
¥1,190+税
LOT 12pcs
4 997337 894098



1150ml
Model N9022
H.67 W.170 D.170mm
フタ取付時サイズ
H.68 W.172 D.172mm
¥1,710+税
LOT 6pcs
4 997337 894111



2000ml
Model N9023
H.77 W.200 D.200mm
フタ取付時サイズ
H.78 W.202 D.202mm
¥1,960+税
LOT 6pcs
4 997337 894128

◎ 冷温対応 本体：-30℃～130℃ / フタ：-20℃～70℃
◎ 電子レンジ・食器洗浄機使用可能。
◎ 電子レンジを使用の際はフタを外してください。
フタの食器洗浄機の使用はお止めください。
[LOT]は予告なく変更する場合があります。
詳しくは担当者までお問い合わせください。

SS food container

材質：304ステンレススチール、ポリプロピレン、シリコーンゴム

◎電子レンジ、オープンでは使用できません。

Round S
H.70 φ115mm 350ml
¥1,200+税



S / Smoke
Model K20-0123S/SM
4 997337 063630

Round L
H.85 φ165mm 850ml
¥1,600+税



L / Smoke
Model K20-0123L/SM
4 997337 063692

Rectangle M
H.69 160×120mm 520ml
¥1,400+税



M / Smoke
Model K20-0124M/SM
4 997337 063784

Rectangle L
H.70 185×130mm 740ml
¥1,600+税

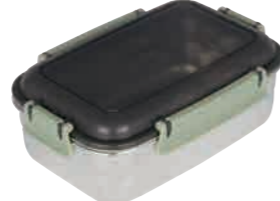

L / Green
Model K20-0124L/GN
4 997337 063838

Food container w / stainless lid

材質：容器 / 耐熱ガラス (耐熱温度差 120℃)
フタ / 18-8ステンレススチール、ポリプロピレン
パッキン / シリコーンゴム



◎電子レンジ・オープン・食器洗浄機の使用可能。
◎電子レンジ・オープンを使用の際はフタを外してください。



S
Model M-0521S
H.55 W.150 D.110mm
350ml
¥1,300+税
4 997337 086080



M
Model M-0521M
H.60 W.177 D.132mm
550ml
¥1,700+税
4 997337 086097



L
Model M-0521L
H.70 W.206 D.155mm
950ml
¥2,100+税
4 997337 086103



Stacking



Jumbo jar

Model K21-0379
H.285 φ205mm
口径 φ145mm
約 7.5L
¥2,200+税
材質：ガラス
18-8ステンレススチール
4 997337 079440



◎パッキンには小さな空気穴があります。フタをゆっくりと閉めていただくと空気が抜けやすくなり、フタの締まりが安定します。



Glass cookie jar

材質：ガラス、PE



3L
Model CH00-H05-3
H.225 W.160 D.160mm
¥1,500+税
4 997337 972031



5L
Model CH00-H05-5
H.260 W.185 D.185mm
¥1,800+税
4 997337 972024



7L
Model CH00-H05
H.295 W.210 D.210mm
¥2,300+税
4 997337 200509

Aluminum scoop



S
Model CH14-K492S
L.180 W.58mm
¥1,000+税
4 997337 449212



M
Model CH14-K492M
L.210 W.80mm
¥1,300+税
4 997337 449229



L
Model CH14-K492L
L.260 W.97mm
¥1,600+税
4 997337 449236



Airtight jar
Model DF-1651
H.265 W.180mm 4.3L
口径 φ80mm
¥1,500+税
材質：ガラス、スチール、
シリコーンゴム
4 997337 165105



Glass jar
Model 1001
H.340 W.190mm 4.5L
口径 φ155mm
¥2,600+税
4 997337 100106



◎こちらのページに掲載されているガラス製品は製造工程上、ガラス表面に気泡や歪みが生じる事があります。製品サイズに若干の個体差があります。
◎耐熱ガラスではありません。急激な温度変化によって割れる場合があります。材質の特性としてご理解ください。



Enameled deep plate

H.53 φ205mm
800ml
¥1,000+税
材質：エナメル、スチール
LOT 4pcs



Beige
Model K19-0101BE
4 997337 063036



Beige / Green
Model K19-0101BE/GN
4 997337 063043



Green
Model K19-0101GN
4 997337 063050

Enameled plate S

H.25 φ206mm
¥1,000+税
材質：エナメル、スチール
LOT 4pcs



Beige
Model K19-0102BE
4 997337 063074



Beige / Green
Model K19-0102BE/GN
4 997337 063104



Green
Model K19-0102GN
4 997337 063111

Enameled plate L

H.27 φ240mm
¥1,100+税
材質：エナメル、スチール
LOT 4pcs



Beige
Model K19-0103BE
4 997337 063128



Beige / Green
Model K19-0103BE/GN
4 997337 063135



Green
Model K19-0103GN
4 997337 063142

Enameled Bowl

H.60 φ138mm
480ml
¥800+税
材質：エナメル、スチール
LOT 4pcs



Beige
Model K19-0100BE
4 997337 063005



Beige / Green
Model K19-0100BE/GN
4 997337 063012



Green
Model K19-0100GN
4 997337 063029

Enameled tumbler

H.95 φ90mm
290ml
¥900+税
材質：エナメル、スチール
LOT 4pcs



Beige / Green
Model K19-0098BE/GN
4 997337 062954



Green
Model K19-0098GN
4 997337 062961



Bottom

Enameled mug

H.82 W.120 D.93mm
360ml
¥900+税
材質：エナメル、スチール
LOT 4pcs



Beige / Green
Model K19-0099BE/GN
4 997337 062985



Green
Model K19-0099GN
4 997337 062992



Beige
Model K19-0099BE
4 997337 062978



SS rim enameled mug

H.82 W.120 D.93mm
360ml
¥900+税
材質：エナメル、スチール
304ステンレススチール
LOT 4pcs



Red / Black
Model Y-0443RBK
4 997337 083195



Black / Green / Black
Model Y-0443BGB
4 997337 083171



Green / Red
Model Y-0443GRD
4 997337 083201



Green / Red / Green
Model Y-0443GRG
4 997337 083188

◎製造工程上プリントの発色や位置等に個体差が生じます。製品特性としてご理解ください。

Enamel cutlery

材質：エナメル、18-0ステンレススチール
Made in JAPAN



LOT 3pcs



Beige
Model K20-304BE

1) Dessert fork
L.188mm
¥1,250+税



3) Cake fork
L.142mm
¥850+税



2) Dessert spoon
L.184mm
¥1,250+税



4) Tea spoon
L.141mm
¥850+税



Green
Model K20-304GN

1) Dessert fork
L.188mm
¥1,250+税



3) Cake fork
L.142mm
¥850+税



2) Dessert spoon
L.184mm
¥1,250+税



4) Tea spoon
L.141mm
¥850+税





Melamine mess tray

Model K20-0275BR
H.24 W.336 D.220mm
¥1,000+税

材質：メラミン樹脂



Melamine mess bowl

Model K20-0278BR
H.45 W.170 D.95mm
480ml
¥600+税

材質：メラミン樹脂



Melamine mess cup pt-1

Model K20-0276BR
H.83 W.117 D.83mm
280ml
¥400+税

材質：メラミン樹脂



Melamine mess cup pt-2

Model K20-0277BR
H.83 W.105 D.83mm
280ml
¥350+税

材質：メラミン樹脂



◎材質の特性上、色味に個体差や黒点など見られる場合があります。模様は黒や白色の箇所ランダムに見られる場合があります。製品の特性としてご理解ください。
◎電子レンジ・オーブンの使用はできません。耐熱温度90℃

Stainless field cutlery

材質：18-8ステンレス
(DINNER KNIFEのみ18-0ステンレス)

◎食器洗浄機の使用可能。



1) Dinner knife

Model K20-0230DK
L.163mm
¥300+税

LOT 12pcs



2) Dinner fork

Model K20-0230DF
L.158mm
¥300+税

LOT 12pcs



3) Dinner spoon

Model K20-0230DS
L.155mm
¥300+税

LOT 12pcs



Stainless field cutlery black

材質：18-8ステンレス
(DINNER KNIFEのみ18-0ステンレス)

PVDコーティング
◎食器洗浄機の使用可能。



1) Dinner knife

Model K20-0230BK/DK
L.163mm
¥300+税

LOT 12pcs



2) Dinner fork

Model K20-0230BK/DF
L.158mm
¥300+税

LOT 12pcs



3) Dinner spoon

Model K20-0230BK/DS
L.155mm
¥300+税

LOT 12pcs



NEW ARRIVAL

CAR & OUTDOOR

FURNITURE

HOUSEWARE

GARDEN & GREEN

KITCHENWARE

SMALL SUNDRIES

Stainless combo plate
材質：304ステンレススチール



A
Model G815-966A
H.20 W.270 D.220mm
¥1,700+税
4 997337 896610



B
Model G815-966B
H.23 W.270 D.220mm
¥1,800+税
4 997337 896627



C
Model G815-966C
H.20 W.330 D.250mm
¥2,100+税
4 997337 896634



D
Model G815-966D
H.20 W.390 D.285mm
¥2,100+税
4 997337 896641



Presentation basket / strainer

材質：フレーム / 201 ステンレススチール
メッシュ / 18-8 ステンレススチール
プレート・チェーン / 18-8 ステンレススチール



S
Model K21-0341S
H.145 W.210 D.90mm
Inside H.55 W.70 D.60mm
¥1,200+税
4 997337 077118



L
Model K21-0341L
H.180 W.230 D.110mm
Inside H.72 W.90 D.80mm
¥1,400+税
4 997337 077101



Package Stacking



付属プレート

S/3 SS Bag clip

材質：本体 / 430 ステンレススチール
スプリング / 201 ステンレススチール



Model RN-0426S/3
H.62 W.76 D.30mm / pc
3pcs / set
¥800+税
4 997337 081221



Package



Long
Model RN-0426L/3
H.72 W.120 D.37mm / pc
3pcs / set
¥1,000+税
4 997337 081238



Package

◎食品の盛り付け及び、水切り・ツール入れ向け製品です。調理器具ではありません。



Glutton oven glove

Model A515-543
H.310 W.175 D.30mm
¥850+税
材質：表面繊維/コットン100%
グローブ/クロロプレンゴム
使用範囲温度：約-20℃~180℃

Color	
● Forest green	4 997337 543668
● Dark gray	4 997337 543880
● Khaki	4 997337 543774
● Mustard	4 997337 543330
● Red	4 997337 543224
● Blue	4 997337 077668



Package

Glutton pot holder

Model A515-544
H.250 W.185 D.10mm
¥650+税
材質：表面繊維/コットン100%
グローブ/クロロプレンゴム
使用範囲温度：約-20℃~180℃

Color	
● Forest green	4 997337 544665
● Dark gray	4 997337 544887
● Khaki	4 997337 544771
● Mustard	4 997337 544337
● Red	4 997337 544221
● Blue	4 997337 077675



Package

Glutton oven mitt

Model A515-545
H.170 W.140 D.50mm
¥750+税
材質：表面繊維/コットン100%
グローブ/クロロプレンゴム
使用範囲温度：約-20℃~180℃

Color	
● Forest green	4 997337 545662
● Dark gray	4 997337 545884
● Khaki	4 997337 545778
● Mustard	4 997337 545334
● Red	4 997337 545228
● Blue	4 997337 077682



Package

Glutton place mat

Model K21-0354
460×340mm
¥800+税
材質：表面繊維/コットン100%
中綿/ポリエステル
ハトメ/真鍮

LOT 3pcs

Color	
● Forest green	4 997337 077712
● Dark gray	4 997337 077705
● Khaki	4 997337 077729
● Mustard	4 997337 077736
● Red	4 997337 077743
● Blue	4 997337 077699



◎ハトメ金具は、縫目と穴が重ならないように個々で位置を調整していますので、ハトメ位置に個体差があります。
◎こちらのページに掲載されている製品は、生産毎に色の濃淡や材質の風合いに多少の個体差があります。



Washed Denim

"EM" apron

Model G619-829
L.630 W.950mm
¥2,800+税

材質：コットン100%



Color	
● Denim	4 997337 682916
● Washed Denim	4 997337 682923
● Hickory Stripe	4 997337 682930
● Natural	4 997337 682954
● Khaki	4 997337 682947



Denim

Hickory Stripe



Natural

Khaki



Khaki

"MW" work apron

Model G619-828
L.800 W.830mm
¥3,200+税

材質：コットン100%
股割れ仕様



Color	
● Denim	4 997337 682817
● Washed Denim	4 997337 682824
● Hickory Stripe	4 997337 682831
● Natural	4 997337 682855
● Khaki	4 997337 682848



Denim

Washed Denim



Hickory Stripe

Natural

Place mat

Model G619-827
L.450 W.330mm
¥350+税
材質：コットン100%
LOT 3pcs



Denim



Washed Denim



Hickory Stripe



Natural



Khaki

**"RV" coaster 4 set**

Model G619-830
110×110mm/pc
¥1,300+税
材質：コットン100%
リバーシブル



A) Washed denim × Natural



B) Khaki × Hickory stripe



C) Denim × Hickory stripe

**Wax canvas lunch bag**

H.380 W.240 D.140mm
¥2,600+税



材質：コットン100% (ワックス加工)
アルミ蒸着フィルム、牛革、真鍮



Camel

Model Y959-1265CAM



Olive

Model Y959-1265OV

**Roughly bag**

Model G659-831
H.740 W.480 D.115mm
¥2,200+税
材質：コットン100%



Hickory Stripe



Natural



Khaki



◎こちらのページに掲載されている製品はハンドメイドのため、生産毎に色の濃淡や、材質の風合いに多少の個体差があります。
◎染色の際に生地が縮み、多少サイズに個体差があります。◎多少の色ムラ・糸のほつれ・糸飛び等があります。商品の特性としてご理解ください。
◎インド綿特有のニオイが気になる場合は、風通しの良い場所で陰干しすることにより解消されます。◎洗濯の際は他の物と分けて洗ってください。

◎こちらのページに掲載されている製品はハンドメイドのため、生産毎に色の濃淡や、材質の風合いに多少の個体差があります。
◎染色の際に生地が縮み、多少サイズに個体差があります。◎多少の色ムラ・糸のほつれ・糸飛び等があります。商品の特性としてご理解ください。
◎インド綿特有のニオイが気になる場合は、風通しの良い場所で陰干しすることにより解消されます。◎洗濯の際は他の物と分けて洗ってください。



Cotton half mesh bag

材質：Color / コットン100%
Natural / オーガニックコットン100%



S

H.630 W.300mm
¥1,400+税

L

H.675 W.400mm
¥1,800+税

S / Yellow

Model T19-0071S/YL

4 997337 080170



S / Gray

Model T19-0071S/GY

4 997337 080194



S / Green

Model T19-0071S/GN

4 997337 080286



S / Natural

Model T19-0071S

4 997337 060004



L / Yellow

Model T19-0071L/YL

4 997337 080187



L / Gray

Model T19-0071L/GY

4 997337 080248



L / Green

Model T19-0071L/GN

4 997337 080293



L / Natural

Model T19-0071L

4 997337 060011



©ハンドメイドのため、生産毎にサイズや色の濃淡、材質の風合いに多少の個体差があります。製品の特性としてご理解ください。



Kitchen cloth

Model S459-189
500×700mm
¥450+税

材質：コットン100%
LOT 5pcs



Navy×Lime green
Model S459-189NBL 4 997337 189767



Yellow×Navy
Model S459-189YLN 4 997337 189378



Blue×Yellow
Model S459-189BLY 4 997337 189439



Brown×Yellow
Model S459-189BRY 4 997337 189736



Green×Blue
Model S459-189GNB 4 997337 189064



Mocha×Red
Model S459-189MOR 4 997337 189729

Chambray kitchen cloth

Model S459-187
500×700mm
¥450+税

材質：コットン100%
LOT 5pcs



Red
Model S459-187RD
4 997337 187022



Navy
Model S459-187NB
4 997337 187053



Olive
Model S459-187OV
4 997337 187060

©インド綿特有のニオイが気になる場合は、風通しの良い場所で陰干しすることにより解消されます。



NEW ARRIVAL

CAR & OUTDOOR

FURNITURE

HOUSEWARE

GARDEN & GREEN

KITCHENWARE

SMALL SUNDRIES



DULTON mug

H.90 W.120 D.85mm
280ml
¥1,500+税
材質：ポーセリン



Boy
Model 122-378BY
4 997337 086318



Fun
Model 122-378FN
4 997337 086325



Light
Model 122-378LT
4 997337 086332

◎電子レンジ・食器洗浄機の使用可能 / オープン使用不可。◎ Made in JAPAN
◎ハンドメイドの製造工程により、柄の位置や仕上げ等に若干の個体差があります。

Terracotta mug

H.85 W.121 D.80mm
280ml
¥780+税
LOT 4pcs



Brown
Model K20-0188BR
4 997337 067836



◎製造工程上、ざらつきや小さな傷・へこみ(ピンホール)がみられる場合があります。
◎生産によりサイズや色の濃淡、材質の風合いに多少の個体差があります。製品の特性としてご理解ください。
◎電子レンジ・オープン(230℃まで)・食器洗浄機でご使用できます。直火・冷凍庫での使用はできません。

Mug with rust rim

H.103 W.117 D.82mm
450ml
¥900+税
材質：ライトポーセリン
LOT 4pcs



Gray
Model K21-0321GY 4 997337 076265

Mug with white rim

Ivory
Model K21-0321IV 4 997337 076289



Turquoise
Model K21-0321TQ 4 997337 076272

Bowl with rust rim

H.48 φ164mm
¥700+税
材質：ライトポーセリン
LOT 5pcs



Gray
Model K21-0322GY 4 997337 076302

Bowl with white rim

Ivory
Model K21-0322IV 4 997337 076326

Cake plate with rust rim

H.27 φ173mm
¥650+税
材質：ライトポーセリン
LOT 5pcs



Gray
Model K21-0324GY 4 997337 076388

Cake plate with white rim

Turquoise
Model K21-0324TQ 4 997337 076395

◎電子レンジ・食器洗浄機使用可 / オープン使用不可 ◎ Made in JAPAN
◎素材や製造工程上、形状・質感に多少のばらつきや、表面に小さな黒点や釉薬上のへこみ(ピンホール)が見られる場合があります。フチ線は手塗り・手引きのため色や幅のムラ・釉ダレ等の個体差が生じます。製品の特性としてご理解ください。





Chunky dessert plate
材質：ライトポーセリン

H.30 φ160mm
¥500+税
LOT 5pcs



Gray
Model K20-0301GY
4 997337 074391



Mustard
Model K20-0301MS
4 997337 074384



Navy
Model K20-0301NB
4 997337 074377



Terracotta
Model K20-0301TR
4 997337 074407

Small chunky bowl
材質：ライトポーセリン

H.55 φ160mm
¥800+税
LOT 5pcs



Gray
Model K20-0302GY
4 997337 074438



Mustard
Model K20-0302MS
4 997337 074421



Navy
Model K20-0302NB
4 997337 074414



Terracotta
Model K20-0302TR
4 997337 074445

Chunky dinner plate
材質：ライトポーセリン

H.35 φ235mm
¥1,000+税
LOT 5pcs



Gray
Model K20-0303GY
4 997337 074476



Mustard
Model K20-0303MS
4 997337 074469



Navy
Model K20-0303NB
4 997337 074452



Terracotta
Model K20-0303TR
4 997337 074483

◎電子レンジ・食器洗浄機使用可/オープン使用不可 ◎Made in JAPAN
◎素材や製造工程上、形状・質感に多少のばらつきや、表面に小さな黒点や釉薬上のへこみ(ピンホール)が見られる場合があります。
手塗りのため色ムラ・釉ダレ等の個性が生じます。製品の特性としてご理解ください。



Glass tableware OBO Gold

材質：本体/ソーダガラス
リム/アクリル塗装、アルミニウム



Bowl 95
Model A515-299GD95
H.50 φ95mm 170ml
¥800+税
LOT 6pcs
4 997337 006316



Bowl 130
Model A515-299GD130
H.60 φ130mm 420ml
¥1,050+税
LOT 4pcs
4 997337 006323



Bowl 205
Model A515-299GD205
H.75 φ205mm 1500ml
¥1,800+税
4 997337 006330



Plate 220
Model A515-302GD220
H.20 φ220mm
¥1,200+税
LOT 4pcs
4 997337 006347



Plate 280
Model A515-302GD280
H.20 φ280mm
¥1,900+税
LOT 4pcs
4 997337 006354

◎大きさや重量、リム幅等に個体差が生じます。
若干の歪み等が生じる場合もあります。製品の特性としてご理解ください。

NEW ARRIVAL

CAR & OUTDOOR

FURNITURE

HOUSEWARE

GARDEN & GREEN

KITCHENWARE

SMALL SUNDRIES

Glass tableware OBO

材質：本体 / ソーダガラス
リム / ニッケルメッキ



Bowl 95
Model A515-299-95
H.50 φ95mm 170ml

¥800+税
LOT 6pcs



Bowl 130
Model A515-299-130
H.60 φ130mm 420ml

¥1,050+税
LOT 4pcs



Bowl 205
Model A515-299-205
H.75 φ205mm 1500ml

¥1,800+税

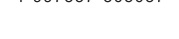

Plate 220
Model A515-302-220
H.20 φ220mm

¥1,200+税

LOT 4pcs



Plate 280
Model A515-302-280
H.20 φ280mm

¥1,900+税

LOT 4pcs



◎大きさや重量、リム幅等に個体差が生じます。若干の歪み等が生じる場合もあります。製品の特性としてご理解ください。



Glass tableware OBO goblet

H.160 φ85mm
280ml

材質：ソーダガラス

LOT 4pcs

Clear
Model M-0516CL
¥1,200+税



Gold rim
Model M-0516GD
¥1,600+税

Rim / 金フィルム



PT rim
Model M-0516PT
¥1,600+税

Rim / プラチナフィルム



◎耐熱ガラスではありません。急激な温度変化によって割れる場合があります。
◎製造工程上、大きさや重量・リム幅等に個体差が生じます。製品の特性としてご理解ください。

Stainless steel wine glass

H.180 φ74mm
350ml
材質：18-8ステンレススチール



Satin
Model M-0519ST
¥1,800+税
4 997337 085953



Mat gold
Model M-0519MGD
¥2,200+税
4 997337 085960



Mat gun
Model M-0519MGU
¥2,200+税
4 997337 085977



Mat copper
Model M-0519MCP
¥2,200+税
4 997337 085984



Package



Double walled bottle cooler

Model M-0520
H.256 W.176 D.180mm
口径 155×160mm
内底 φ110mm
¥7,000+税
材質：18-8ステンレススチール
4 997337 085991

◎Satin以外のカラーは食器洗浄機の使用はできません。◎発色や風合いに個体差があります。製品の特性としてご理解ください。



Honeycomb wine rack

材質：スチール



Metal wine rack

材質：アイアン

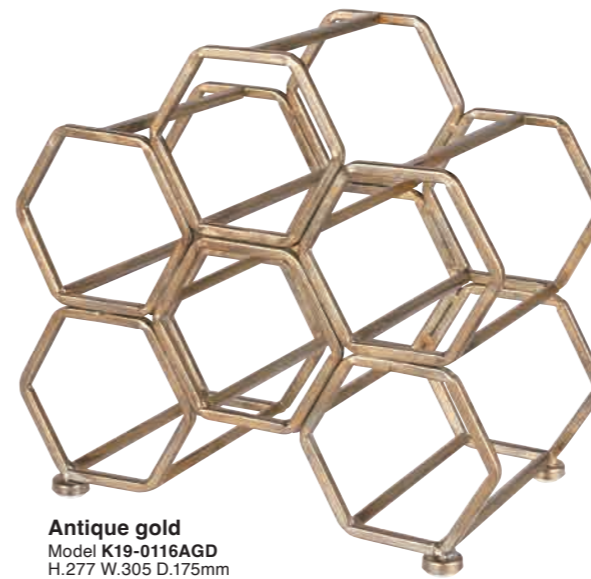

Antique gold
Model K19-0116AGD
H.277 W.305 D.175mm
¥5,800+税
4 997337 063487

◎形状によっては収納できません。

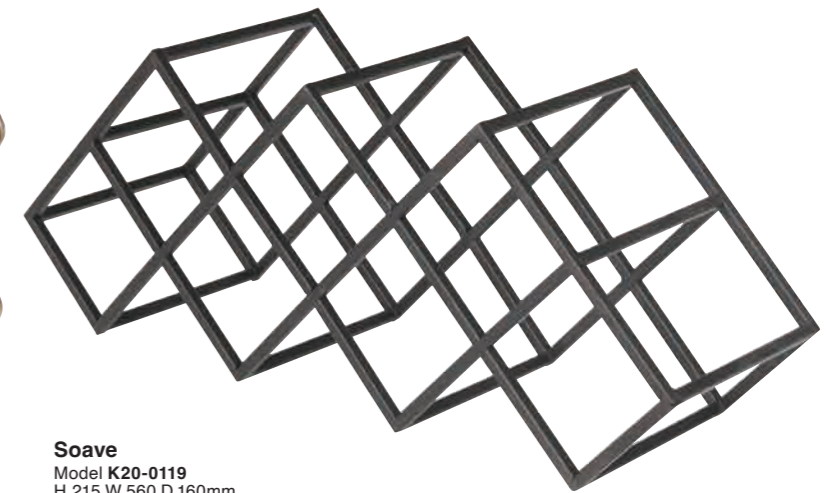

Soave
Model K20-0119
H.215 W.560 D.160mm
¥6,000+税
4 997337 063494

◎形状によっては収納できません。

Sommelier knife



◎製品の一部分に木材を使用しています。自然素材のため木目や色の出方に個体差があります。



Ebony
Model B711-898
L.115mm
¥1,600+税
4 997337 718981

材質：2CR13ステンレススチール、エボニーウッド



Pakka wood
Model B911-1291
L.115mm
¥1,600+税
4 997337 006262

材質：2CR13ステンレススチール、パッカウッド



Fish sommelier knife "Oak"
Model B711-901
L.125mm
¥1,600+税
4 997337 179010

材質：2CR13ステンレススチール、オーク



共通 Package

"Marguerite" 

Glass bowl
Model S215-15CL
H.75 φ95mm 190ml
¥650+税



Glass cup
Model S215-16CL
H.70 φ73mm 150ml
¥550+税



Glass cup
Model S315-122CL
H.100 φ80mm 300ml
¥700+税



Glass tumbler S
Model S115-23S/CL
H.100 φ80mm 280ml
¥650+税



Glass tumbler L
Model S115-23L/CL
H.130 φ80mm 350ml
¥750+税



Aqua glass
Model S015-51CL
H.140 φ80mm 240ml
¥850+税



Fruits bowl
Model S115-24CL
H.70 φ130mm
¥850+税



◎耐熱ガラスではありません。
急激な温度変化によって割れる場合があります。
◎電子レンジ・食器洗浄機・オープンでは使用できません。
◎製造工程上、若干の歪みやスジが生じる場合があります。
あらかじめご了承ください。



"Fern"

材質：ソーダガラス

◎耐熱ガラスではありません。急激な温度変化によって割れる場合があります。
◎製造工程上、若干の歪みやスジが生じる場合があります。あらかじめご了承ください。

Glass tumbler S
Model M-0518S
H.100 φ80mm
280ml
¥750+税
LOT 4pcs



Glass tumbler L
Model M-0518L
H.125 φ80mm
350ml
¥900+税
LOT 4pcs



Aqua glass
Model M-0517
H.170 φ80mm
300ml
¥1,100+税
LOT 4pcs



"Fleur de lis" 

Glass cup
Model S315-21
H.100 φ90mm 300ml
¥750+税



Aqua glass
Model S315-20
H.165 φ90mm 300ml
¥950+税



Bormioli "BODEGA"

材質：全面物理強化ガラス
◎電子レンジ・食器洗浄機使用可能。

200ml
Model 710860
H.60 φ82mm
¥570+税
LOT 12pcs



370ml
Model 710870
H.90 φ85mm
¥740+税
LOT 3pcs



500ml
Model 710880
H.120 φ88mm
¥890+税
LOT 3pcs



[LOT] は予告なく変更する場合があります。詳しくは担当者までお問い合わせください。

NEW ARRIVAL

CAR & OUTDOOR

FURNITURE

HOUSEWARE

Duralex "Picardie"

[LOT] は予告なく変更する場合があります。詳しくは担当者までお問い合わせください。



Model 11960
H.67 φ65mm 90ml
¥320+税
LOT 6pcs
4 997337 011969



Model 11970
H.72 φ69mm 130ml
¥390+税
LOT 6pcs
4 997337 011976



Model 11980
H.78 φ75mm 160ml
¥450+税
LOT 6pcs
4 997337 011983



Model 11990
H.84 φ80mm 220ml
¥520+税
LOT 6pcs
4 997337 011990



Model 10330
H.145 φ94mm 500ml
¥1,050+税
LOT 6pcs
4 997337 013307



Model 12000
H.90 φ86mm
250ml
LOT 6pcs
Clear



Amber

Color Price
○ Clear ¥570+税 4 997337 120005
● Amber ¥650+税 4 997337 120009



Model 11810
H.94 φ90mm
310ml
LOT 6pcs
Clear



Amber

Color Price
○ Clear ¥650+税 4 997337 118101
● Amber ¥700+税 4 997337 118187



Model 10320
H.124 φ88mm
360ml
LOT 6pcs
Clear



Amber

Color Price
○ Clear ¥1,000+税 4 997337 013208
● Amber ¥1,150+税 4 997337 086110

◎強化ガラス / 耐熱温度 -20℃~100℃ ◎電子レンジ・食器洗浄機使用可能。



Nonix



290ml
Model 517210
H.115 φ74mm
¥660+税
LOT 12pcs
4 997337 172103



580ml
Model 517220
H.153 φ89mm
¥920+税
LOT 12pcs
4 997337 172202

◎強化ガラス / 耐熱温度 -20℃~100℃ ◎電子レンジ・食器洗浄機使用可能。

Glass cup & saucer "Fiore"



Model A615-818
Saucer H.23mm φ150mm
Cup H.65 W.160 D.120mm
160ml
¥1,400+税



Clear
4 997337 681803



Amber
4 997337 681872



Blue
4 997337 681858



Green
4 997337 681865

◎耐熱ガラスではありません。電子レンジ・食器洗浄機・オーブンでは使用できません。



Beverage server



Ivy
Model M411-216
H.295 W.130 D.180mm 3L
¥2,300+税
4 997337 216418



Eerin S
Model M411-218S
H.320 W.200 D.250mm 6L
¥4,200+税
4 997337 421812



Eerin L
Model M411-218L
H.365 W.215 D.260mm 7L
¥4,700+税
4 997337 421836

◎蓋が密閉式になっております。飲み物を注ぐ際は、蓋のワイヤーロックを解除してください。



Tin tray stand
Model A715-867
H.180 φ250mm
土台接地部 φ140mm
¥2,200+税
4 997337 758673

◎食品を直にのせないでください。
◎BEVERAGE SERVER Eerinのスタンドとしても使用できます。

【BEVERAGE SERVERシリーズ使用適合表】

Model M411-216	Model M411-218
BEVERAGE SERVER Ivy	BEVERAGE SERVER Eerin S/Lサイズ
× 転倒の恐れがあります。ご使用いただけません。	○ ご使用いただけます。

Glass jar



Glass jar Cornet S
Model SG1275-1
H.300 W.150 φ130mm
¥3,800+税
4 997337 112758



Glass jar Cornet M
Model SG1275
H.420 W.200 φ165mm
¥6,300+税
4 997337 412759



Glass jar Amande S
Model SG457-1
H.375 W.150 φ130mm
¥3,800+税
4 997337 445719



Glass jar Dressage
Model SG1690
H.450 W.180 φ115mm
¥6,300+税
4 997337 416900



Glass jar Sourire
Model SG1408
H.305 W.252 φ150mm
¥5,000+税
4 997337 414081

◎こちらのページに掲載されている製品は耐熱ガラスではありません。急激な温度変化によって割れる場合があります。
◎製造工程上ガラス表面に気泡や歪みが生じる事があります。材質の特性としてご理解ください。

NEW ARRIVAL

CAR & OUTDOOR

FURNITURE

HOUSEWARE

GARDEN & GREEN

KITCHENWARE

SMALL SUNDRIES



Glass dome S
Model SG1945-1WS
H.375 φ225mm
¥6,500+税
4 997337 194518

◎食品を直にのせないでください。



Glass dome miroirs M
Model SG794WS
H.230 φ260mm
¥6,800+税
4 997337 977944

◎食品を直にのせないでください。



Cake stand "Pleats plate"
Model S315-75
H.80 φ170 (平面φ125mm)
¥1,700+税
4 997337 315753

◎製造工程上、ガラス表面に気泡や歪みが生じる事があります。材質の特性としてご理解ください。



Glass compote "Macaron" S
Model S81126S
H.115 φ230 (平面φ210mm)
¥2,000+税
4 997337 112611



Glass compote "Macaron" L
Model S81126L
H.115 φ300 (平面φ280mm)
¥2,500+税
4 997337 112635

ケーキサイズ

号数	直径
4号	120mm
5号	150mm
6号	180mm
7号	210mm
8号	240mm
9号	270mm

Acacia wood compot
材質：アカシア



S
Model K20-0156S
H.72 φ150 (平面φ100mm)
¥3,200+税
4 997337 066761



M
Model K20-0156M
H.92 φ215mm
¥4,200+税
4 997337 066730



◎天然木のアカシアから切り出し製造しています。
◎自然素材の為、木目や色の出方には個体差があります。
製品の特性としてご理解ください。



L
Model K20-0156L
H.132 φ245mm
¥5,500+税
4 997337 066747

Acacia cutting board
材質：アカシア

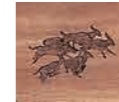

焼印ロゴ



S
Model M5029
H.12 L.400 D.183mm
Weight 600g
¥2,800+税
4 997337 502931



L
Model M5030
H.12 L.515 D.203mm
Weight 800g
¥3,400+税
4 997337 503037



Rectangle M
Model M411-254M
H.16 W.345 D.170mm
¥2,900+税
4 997337 425421

Acacia tray with metal handle
材質：アカシア、18-0ステンレススチール



Rectangle S
Model K19-0106S
H.20 W.300 D.185mm
¥3,600+税
4 997337 063173



Rectangle M
Model K19-0106M
H.20 W.310 D.195mm
¥4,000+税
4 997337 063180



Rectangle L
Model K19-0106L
H.20 W.428 D.267mm
¥4,400+税
4 997337 063197

Acacia cutlery stand
Model K19-0108
H.130 W.120 D.80mm
¥2,300+税
材質：アカシア、18-0ステンレススチール



Acacia cutlery case
Model K19-0109
H.50 W.310 D.90mm
¥2,600+税
材質：アカシア、18-0ステンレススチール



◎天然木のアカシアから切り出し製造しています。
◎自然素材の為、木目や色の出方には個体差があります。
製品の特性としてご理解ください。

Coffee mill "TERRA"

Model A715-888
H.220 W.155 D.80mm
¥3,500+税

材質：本体/アイアン、ニッケルメッキ
受け容器/ストーンウェア、シリコンゴム
グラインダー/セラミック
ハンドル/アイアン、バーチウッド



Package



Abyssal blue



Forest green



Acacia wood coffee Spoon 10g

Model K20-0159
H.20.8 W.7.0 D.38mm 10g
¥800+税

材質：アカシア

LOT 4pcs



◎天然木のアカシアから切り出し製造しています。
◎自然素材の為、木目や色の出方には個体差があります。
製品の特性としてご理解ください。

Tea infuser At sea day

H.83 W.62 D.42mm
Tray H.2 W.60 D.47mm
¥900+税

材質：ポリプロピレン、
18-8ステンレススチール



Package



Orange / Green
Model K21-0339OGN



Yellow / Sax
Model K21-0339YSB



◎ステンレス以外の樹脂部分は圧着固定されているため分解できません。

Tea infuser T.fisherman

Model 46738
Fisherman H.55 W.22mm
Strainer φ50mm
Chain L.100mm
¥1,200+税

材質：18-8 ステンレススチール
シリコンゴム



Package



image

Color

● Gray



● Blue



◎カップの形状や厚さによっては
ご使用できない場合があります。
◎カップは付属しません。



Mug infuser w/ double-use tray

H.74 W.130 D.66mm
Tray H.6 φ69mm
¥1,400+税

材質：18-8ステンレススチール



Package

Hole

Model K21-0340HO



◎付属トレイはフタ、受け皿と兼用で使用可能です。

Stainless drip / water pot 650ml

Model R815-1006-65
H.120 W.210 D.90mm
適正容量 500ml
¥2,500+税



◎IH調理器・直火使用不可

⇒このシリーズのその他の製品は
P39に掲載されています。



Classic bottle opener

Model S310-106
L.93 W.40 D.5mm
¥350+税



Package

Glass tea pot



"Pumpkin"

Model S415-168
H.125 W.185 D.120mm 600ml
¥2,300+税



◎耐熱ガラス -20℃~120℃



"Mirliton"

Model S415-169
H.135 W.210 D.120mm 700ml
¥2,400+税



◎耐熱ガラス -20℃~120℃



Glass farmer plate



Lemon
Model G815-973LE
H.33×130×200mm
¥380+税
LOT 6pcs
4 997337 973816



Cabbage
Model G815-973CB
H.42×133×205mm
¥380+税
LOT 6pcs
4 997337 973823



Peanut
Model G815-973PN
H.20×115×210mm
¥380+税
LOT 6pcs
4 997337 973847



Kiwi
Model G815-973KW
H.20×158×208mm
¥380+税
LOT 6pcs
4 997337 973854



Artichoke
Model G815-973AC
H.25×173×252mm
¥480+税
LOT 6pcs
4 997337 973876



Apple
Model G815-973AP
H.25×250×253mm
¥580+税
LOT 6pcs
4 997337 973885



Hamburger
Model G815-973HB
H.22×243×247mm
¥580+税
LOT 6pcs
4 997337 973892



Strawberry
Model G815-973SB
H.25×248×200mm
¥480+税
LOT 6pcs
4 997337 973113



Tomato
Model G815-973TM
H.33×186×200mm
¥480+税
LOT 6pcs
4 997337 973120



Bread
Model G815-973BR
H.20×200×165mm
¥480+税
LOT 6pcs
4 997337 973106



Pizza
Model G815-973PZ
H.20×162×153mm
¥300+税
LOT 6pcs
4 997337 973090

Glass fishery plate

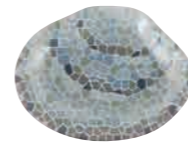

Clam
Model K20-0133CLAM
H.11×90×68mm
¥180+税
LOT 6pcs
4 997337 064989



Sardine
Model K20-0133SAR
H.15×220×80mm
¥280+税
LOT 6pcs
4 997337 064996

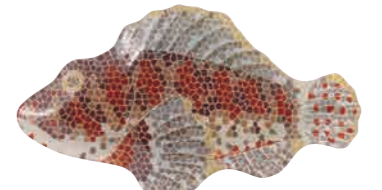

Scorpionfish
Model K20-0133SCO
H.16×250×139mm
¥380+税
LOT 6pcs
4 997337 065009

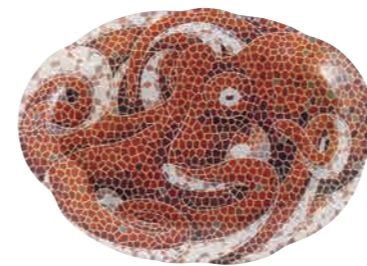

Octopus
Model K20-0133OCT
H.22×258×185mm
¥580+税
LOT 6pcs
4 997337 065023

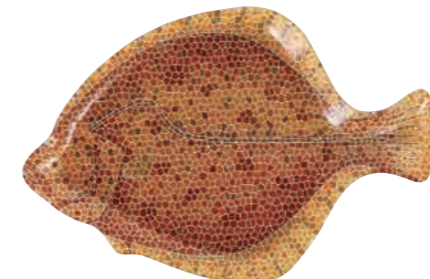

Flounder
Model K20-0133FLO
H.20×295×195mm
¥580+税
LOT 6pcs
4 997337 065054

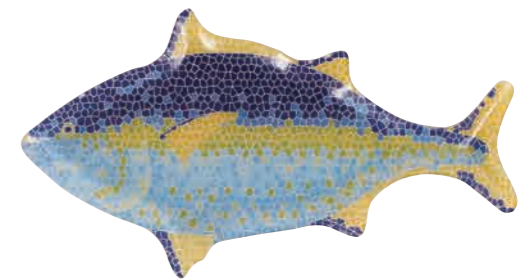

Tuna
Model K20-0133TUNA
H.17×373×198mm
¥780+税
LOT 6pcs
4 997337 065061





M&B standard cup 
 Model K915-1277
 H.90 φ80mm
 280ml
 ¥500+税
 材質：メラミン樹脂、バンブーファイバー
 ◎耐熱温度 -20℃~70℃
 ◎電子レンジ・オーブン使用不可。
 ◎食器洗浄機の使用可能。



Color
 ● Sax 4 997337 005739
 ● Green 4 997337 005746
 ● Orange 4 997337 005753
 ● Yellow 4 997337 005777
 ● Greige 4 997337 077972
 ● Gray 4 997337 077989



◎天然素材を含んでいるため、色や風合いに個体差があります。

M&B grip cup 420ml 
 Model K21-0356
 H.100 W.88 D.120mm
 420ml
 ¥700+税
 材質：メラミン樹脂、バンブーファイバー
 LOT 6pcs
 ◎耐熱温度 -20℃~70℃
 ◎電子レンジ・オーブン使用不可。
 ◎食器洗浄機の使用可能。



Color
 ● Sax 4 997337 077996
 ● Green 4 997337 078009
 ● Orange 4 997337 078016
 ● Yellow 4 997337 078023
 ● Greige 4 997337 078030
 ● Gray 4 997337 078047



◎天然素材を含んでいるため、色や風合いに個体差があります。

M&B bowl 
 Model K915-1276
 H.69 φ147mm
 650ml
 ¥600+税
 材質：メラミン樹脂、バンブーファイバー
 ◎耐熱温度 -20℃~70℃
 ◎電子レンジ・オーブン使用不可。
 ◎食器洗浄機の使用可能。



Color
 ● Sax 4 997337 005692
 ● Green 4 997337 005708
 ● Orange 4 997337 005715
 ● Yellow 4 997337 005722
 ● Greige 4 997337 077958
 ● Gray 4 997337 077965



◎天然素材を含んでいるため色や風合いに個体差があります。

NEW ARRIVAL

CAR & OUTDOOR

FURNITURE

HOUSEWARE

GARDEN & GREEN

KITCHENWARE

SMALL SUNDRIES

M&B square partition tray

Model K21-0357
H.32 W.187 D.187mm
¥1,500+税

材質：メラミン樹脂、バンブーファイバー

LOT 4pcs

- ◎耐熱温度 -20℃~70℃
- ◎電子レンジ・オープン使用不可。
- ◎食器洗浄機の使用可能。



Color	Barcode
● Sax	4 997337 078054
● Green	4 997337 078061
● Orange	4 997337 078078
● Yellow	4 997337 078085
● Greige	4 997337 078092
● Gray	4 997337 078108

◎天然素材を含んでいるため
色や風合いに個体差があります。



Sax



Green



Orange



Yellow



Greige



Gray



M&B deep plate

材質：メラミン樹脂、バンブーファイバー

- ◎耐熱温度 -20℃~70℃
- ◎電子レンジ・オープン使用不可。
- ◎食器洗浄機の使用可能。



S

Model K21-0358S
H.47 φ150mm
¥600+税

LOT 6pcs

Color	Barcode
● Sax	4 997337 078115
● Green	4 997337 078122
● Orange	4 997337 078139
● Yellow	4 997337 078146
● Greige	4 997337 078153
● Gray	4 997337 078160



Sax



Green



Orange



Yellow



Greige



Gray

◎天然素材を含んでいるため
色や風合いに個体差があります。

L

Model K21-0358L
H.45 φ208mm
¥800+税

LOT 6pcs

Color	Barcode
● Sax	4 997337 078177
● Green	4 997337 078184
● Orange	4 997337 078191
● Yellow	4 997337 078207
● Greige	4 997337 078214
● Gray	4 997337 078221



Sax



Green



Orange



Yellow



Greige



Gray



M&B shallow plate



材質：メラミン樹脂、バンブーファイバー

- ◎耐熱温度 -20℃~70℃
- ◎電子レンジ・オープン使用不可。
- ◎食器洗浄機の使用可能。

◎天然素材を含んでいるため
色や風合いに個体差があります。

L
Model K21-0359L
H.15 φ265mm
¥850+税
LOT 6pcs

S
Model K21-0359S
H.13 φ176mm
¥550+税
LOT 6pcs

Color	
● Sax	4 997337 078238
● Green	4 997337 078245
● Orange	4 997337 078252
● Yellow	4 997337 078269
● Greige	4 997337 078276
● Gray	4 997337 078283



M
Model K21-0359M
H.15 φ222mm
¥650+税
LOT 6pcs

Color	
● Sax	4 997337 078290
● Green	4 997337 078306
● Orange	4 997337 078313
● Yellow	4 997337 078320
● Greige	4 997337 078337
● Gray	4 997337 078344

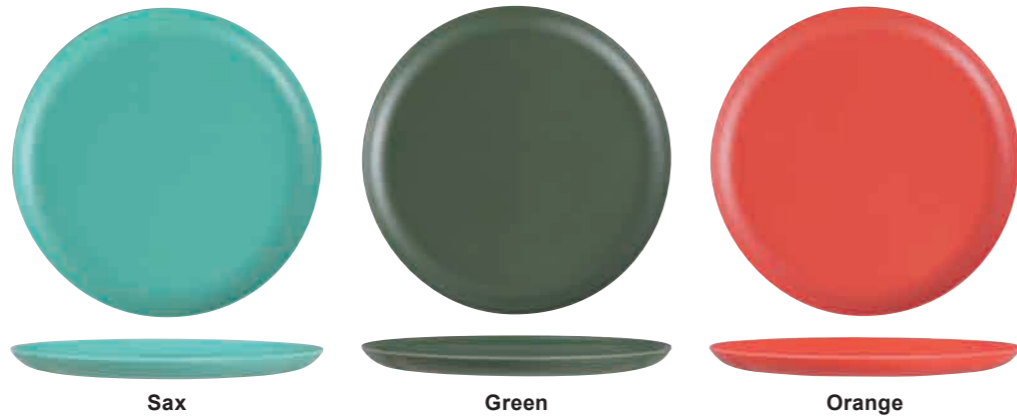

Color	
● Sax	4 997337 078351
● Green	4 997337 078368
● Orange	4 997337 078375
● Yellow	4 997337 078382
● Greige	4 997337 078399
● Gray	4 997337 078443



NEW ARRIVAL

CAR & OUTDOOR

FURNITURE

HOUSEWARE

GARDEN & GREEN



M&B 8 plate

Model K915-1275-8
H.14 φ199mm
¥500+税

材質：メラミン樹脂
バンブーファイバー

- ◎耐熱温度 -20℃~70℃
- ◎電子レンジ・オーブン使用不可。
- ◎食器洗浄機の使用可能。



Color

● Sax



● Green



● Orange



● Yellow



◎天然素材を含んでいるため
色や風合いに個体差があります。



Sax



Green



Orange



Yellow



M&B kids plate set

材質：メラミン樹脂、バンブーファイバー

- ◎耐熱温度 -20℃~70℃
- ◎電子レンジ・オーブン使用不可。
- ◎食器洗浄機の使用可能。



Package

"Car"

Model K915-1274C
¥2,500+税

Tray
H.30 W.290 D.196mm
Mug
H.76 W.101 D.75mm 220ml
Fork
L.131mm
Spoon
L.135mm



"Helicopter"

Model K915-1274H
¥2,500+税

Tray
H.32 W.306 D.203mm
Mug
H.76 W.101 D.75mm 220ml
Fork
L.131mm
Spoon
L.135mm



◎天然素材を含んでいるため色や風合いに個体差があります。



M&B serving tray

材質：メラミン樹脂、バンブーファイバー



- ◎耐熱温度 -20℃~70℃
- ◎電子レンジ・オーブン使用不可。
- ◎食器洗浄機の使用可能。

◎食品を直に載せることも可能です。
◎天然素材を含んでいるため色や風合いに個体差があります。

S

H.23 W.327 D.203mm
Inside W.280 D.180

¥700+税

LOT 4pcs



S / Greige

Model K21-0361S/GRG



L

H.32 W.430 D.268mm
Inside W.365 D.240

¥1,200+税

LOT 4pcs



L / Greige

Model K21-0361L/GRG



S / Gray

Model K21-0361S/GY



L / Gray

Model K21-0361L/GY



M&B mixing bowl



材質：メラミン樹脂、パンプーフाइバー

- ◎耐熱温度 -20℃~70℃
- ◎電子レンジ・オーブン使用不可。
- ◎食器洗浄機の使用可能。

S

H.122 W.207 D.182mm
満水容量 2L

¥770+税

LOT 4pcs



S / Greige

Model K21-0360S/GRG



4 997337 078450

M

H.126 W.249 D.215mm
満水容量 2.8L

¥980+税

LOT 4pcs



M / Greige

Model K21-0360M/GRG



4 997337 078474



S / Gray

Model K21-0360S/GY



4 997337 078467



M / Gray

Model K21-0360M/GY



4 997337 078481

◎底部には滑り止めのシリコンリングが接着固定されています。

◎天然素材を含んでいるため、色や風合いに個体差があります。



Carry snack tub with tumbler

Tub H.80 φ175mm
Tumbler H.120 φ100mm 400ml
¥1,700+税

材質：タブ・タンブラー / AS樹脂
ストロー / ポリエチレン



Package



Red

Model Y915-1282RD



4 997337 005999



Yellow

Model Y915-1282YL



4 997337 005982



Bird toothpick server

Model S216-81
H.105 W.95 D.95mm
¥1,400+税



4 997337 216814

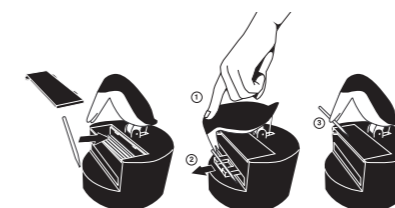

- ◎頭を押すとベース部分から出てくる楊枝をくちばしでキャッチします。
- ◎楊枝は付属しません。



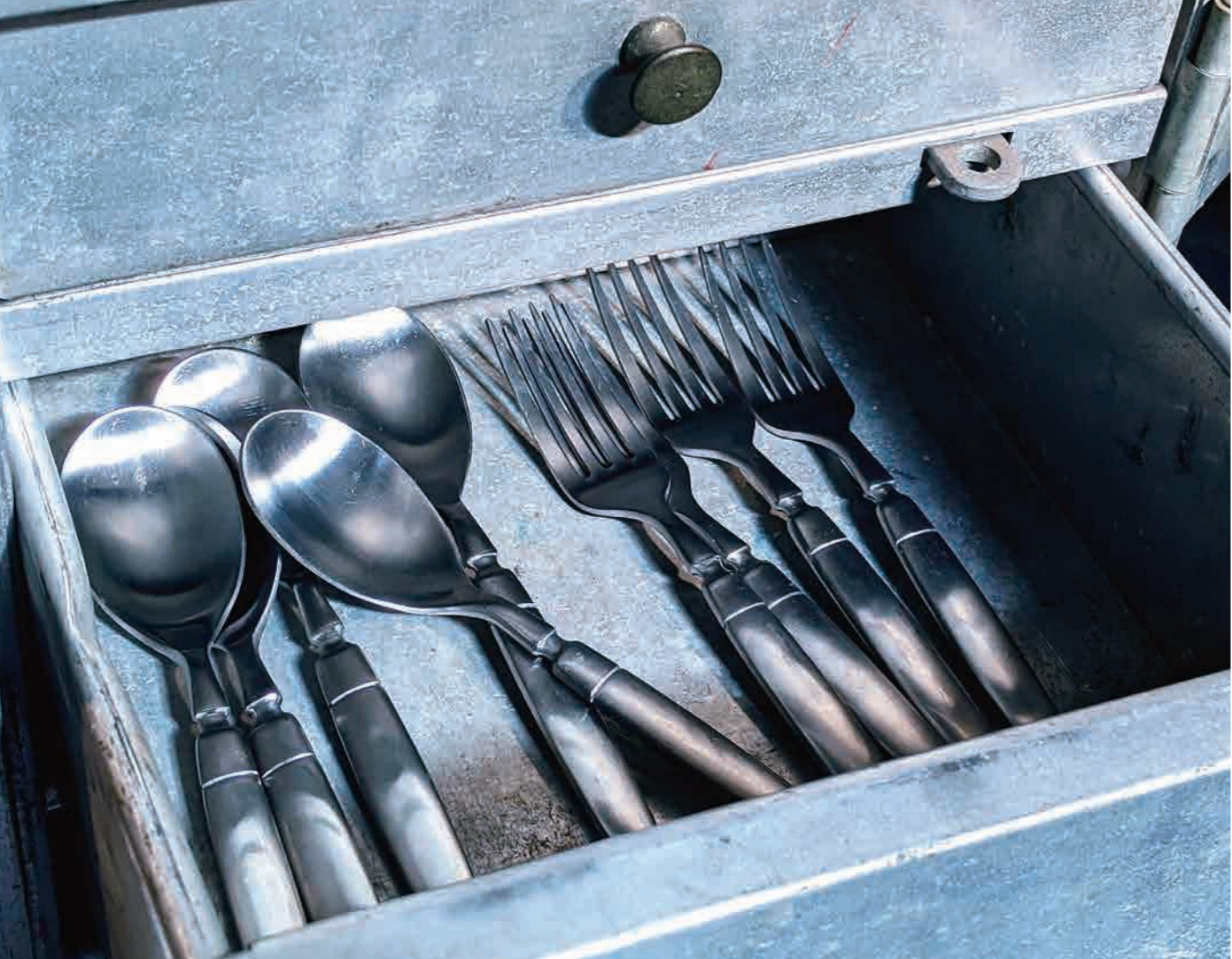

Flat handle cutlery 
Model G603
LOT 12pcs



1) Dinner knife L.220mm ¥450+税		4) Cake fork L.158mm ¥350+税	
2) Dinner fork L.198mm ¥450+税		5) Tea spoon L.145mm ¥350+税	
3) Dinner spoon L.200mm ¥450+税		6) Coffee spoon L.120mm ¥330+税	

材質：18-0ステンレススチール（Dinner Knifeのみ13-0ステンレススチール）
◎食器洗浄機の使用可能。

Kantine cutlery
Model K20-0131
LOT 6pcs



1) Dinner knife L.227mm ¥480+税		4) Dessert fork L.155mm ¥450+税	
2) Dinner Fork L.193mm ¥480+税		5) Dessert spoon L.153mm ¥450+税	
3) Dinner Spoon L.192mm ¥480+税		6) Coffee spoon L.123mm ¥420+税	

材質：18-0ステンレススチール ◎食器洗浄機の使用可能。
◎ハンドメイドの製造工程により、長さや仕上げ等に若干の個体差があります。

Dent cutlery
Model K20-0132
LOT 6pcs



1) Dinner knife L.201mm ¥380+税		4) Dessert fork L.152mm ¥350+税	
2) Dinner Fork L.185mm ¥380+税		5) Dessert spoon L.150mm ¥350+税	
3) Dinner Spoon L.183mm ¥380+税		6) Coffee spoon L.120mm ¥320+税	

材質：18-0ステンレススチール ◎食器洗浄機の使用可能。
◎ハンドメイドの製造工程により、長さや仕上げ等に若干の個体差があります。



Svelte Cutlery Mat Silver
Model DTCT-19SV
LOT 6pcs



- | | |
|---|--|
| 1) Dinner Knife
L.215mm
¥700+税
4 997337 190718 | 4) Dessert Fork
L.150mm
¥600+税
4 997337 190749 |
| 2) Dinner Fork
L.205mm
¥700+税
4 997337 190725 | 5) Dessert Spoon
L.144mm
¥600+税
4 997337 190756 |
| 3) Dinner Spoon
L.198mm
¥700+税
4 997337 190732 | 6) Coffee Spoon
L.124mm
¥600+税
4 997337 190763 |

材質：18-8ステンレス (Dinner Knifeのみ13-0ステンレス)
◎食器洗浄機の使用可能。

Svelte Cutlery Mat Gold
Model DTCT-19GD
LOT 6pcs



- | | |
|---|--|
| 1) Dinner Knife
L.215mm
¥900+税
4 997337 190817 | 4) Dessert Fork
L.150mm
¥850+税
4 997337 190848 |
| 2) Dinner Fork
L.205mm
¥900+税
4 997337 190824 | 5) Dessert Spoon
L.144mm
¥850+税
4 997337 190855 |
| 3) Dinner Spoon
L.198mm
¥900+税
4 997337 190831 | 6) Coffee Spoon
L.124mm
¥850+税
4 997337 190862 |

材質：18-8ステンレス (Dinner Knifeのみ13-0ステンレス)
チタンコーティング ◎食器洗浄機の使用はできません。

Svelte Cutlery Mat Black
Model DTCT-19BK
LOT 6pcs



- | | |
|---|--|
| 1) Dinner Knife
L.215mm
¥900+税
4 997337 190916 | 4) Dessert Fork
L.150mm
¥850+税
4 997337 190947 |
| 2) Dinner Fork
L.205mm
¥900+税
4 997337 190923 | 5) Dessert Spoon
L.144mm
¥850+税
4 997337 190954 |
| 3) Dinner Spoon
L.198mm
¥900+税
4 997337 190930 | 6) Coffee Spoon
L.124mm
¥850+税
4 997337 190961 |

材質：18-8ステンレス (Dinner Knifeのみ13-0ステンレス)
チタンコーティング ◎食器洗浄機の使用はできません。

Vandule cutlery
Model DTCT-16
LOT 6pcs



- | | |
|---|--|
| 1) Dinner knife
L.215mm
¥730+税
4 997337 421614 | 5) Dessert spoon
L.144mm
¥650+税
4 997337 421645 |
| 2) Dinner fork
L.205mm
¥730+税
4 997337 421621 | 6) Coffee spoon
L.124mm
¥630+税
4 997337 421669 |
| 3) Dinner spoon
L.196mm
¥730+税
4 997337 421638 | 7) Tiny fork
L.93mm
¥500+税
4 997337 421683 |
| 4) Dessert fork
L.150mm
¥650+税
4 997337 421652 | 8) Tiny spoon
L.93mm
¥500+税
4 997337 421676 |

材質：18-8ステンレス (Dinner Knifeのみ13-0ステンレス)
◎食器洗浄機の使用はできません。

◎持ち手部分には焼きつけによる加工を施しておりますので
初回使用前の洗浄で若干加工が落ちる場合がございます。
製品の特性としてご理解ください。
◎強く擦ったり磨いたりすると表面の色が落ちたり、
色移りする可能性があります。
◎ハンドメイドの製造工程により、長さや色、仕上げに
若干の個体差があります。

Svelte Cutlery Mat Copper
Model DTCT-19CP
LOT 6pcs



- | | |
|---|--|
| 1) Dinner Knife
L.215mm
¥900+税
4 997337 190619 | 4) Dessert Fork
L.150mm
¥850+税
4 997337 190640 |
| 2) Dinner Fork
L.205mm
¥900+税
4 997337 190626 | 5) Dessert Spoon
L.144mm
¥850+税
4 997337 190657 |
| 3) Dinner Spoon
L.198mm
¥900+税
4 997337 190633 | 6) Coffee Spoon
L.124mm
¥850+税
4 997337 190664 |

材質：18-8ステンレス (Dinner Knifeのみ13-0ステンレス)
チタンコーティング ◎食器洗浄機の使用はできません。

Cutlery rest Square
Model R615-844
H.10 W.70 D.8mm
LOT 4pcs



- | | | | |
|--|--|---|--|
| 材質：Satin / 18-8ステンレス
Black / チタンコーティング
Mat gold / チタンメッキ
◎食器洗浄機の使用はできません。 | Satin finished
¥900+税
4 997337 684415 | Black
¥900+税
4 997337 684422 | Mat gold
¥900+税
4 997337 684439 |
|--|--|---|--|



◎こちらのページに掲載されている製品は、ハンドメイドの製造工程により、長さや色、仕上げに若干の個体差があります。
◎発色加工時の固定跡が見られる場合があります。製造工程上の特性としてご理解ください。

Butter knife fish

Model S516-323
L.135mm
¥1,200+税
材質：亜鉛合金 (クロムコーティング)
◎食器洗浄機の使用はできません。
4 997337 563239



Butter knife "Colon"

Model G3449
H.140 W.40mm
¥480+税
材質：18-0ステンレス、ABS樹脂
耐熱温度 80℃
◎食器洗浄機の使用はできません。

- | | |
|--------------|-----------------|
| Color | |
| Ivory | 4 997337 344913 |
| Red | 4 997337 344920 |
| Blue | 4 997337 344955 |
| Green | 4 997337 344968 |
| Pink | 4 997337 344982 |



The DULPEDIA 2024

SMALL SUNDRIES

Desktop 334

Fashion Glasses 352

Glasses Accessory 354

DULTON Goods 356





Stackable drawer

材質：スチール



Horizontal
Model 121-376
H.73 W.320 D.240mm
¥5,400+税



Galvanized
Model 121-376GV
4 997337 080392



Ivory
Model 121-376IV
4 997337 080385

Vertical
Model 121-377
H.73 W.240 D.320mm
¥5,400+税



Galvanized
Model 121-377GV
4 997337 080415

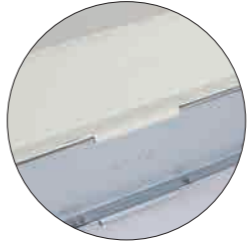

◎最大3個までスタッキング可能。
◎背面には固定用のフックがあります。



Ivory
Model 121-377IV
4 997337 080408

Partition storage

材質：亜鉛鉄板



◎仕切りのワイヤーは取り外し可能。

S / Galvanized
Model D20-0210S/GV
H.320 W.200 D.250mm
¥3,600+税
4 997337 068727



M / Galvanized
Model D20-0210M/GV
H.320 W.300 D.250mm
¥4,300+税
4 997337 068741

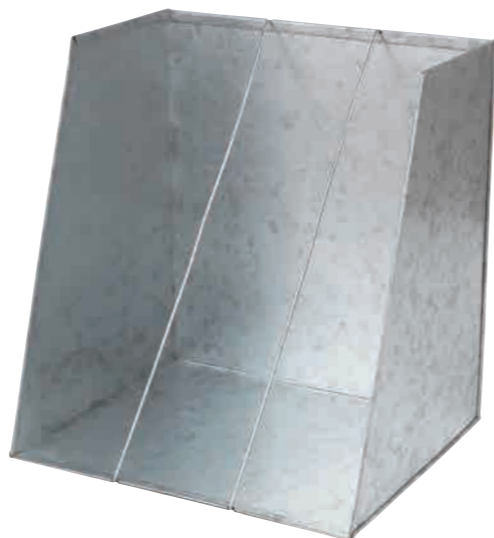

File box

材質：亜鉛鉄板



S / Galvanized
Model D20-0209S/GV
H.250 W.100 D.320mm
¥3,500+税
4 997337 068680

M / Galvanized
Model D20-0209M/GV
H.250 W.150 D.320mm
¥3,800+税
4 997337 068703



Metal clip board

材質：ボード/アルミニウム
クリップ/真鍮(Brass)、スチール(Galvanized)



A6
Model 117-330A6
120×190mm



Package

Brass
¥1,400+税
4 997337 733014

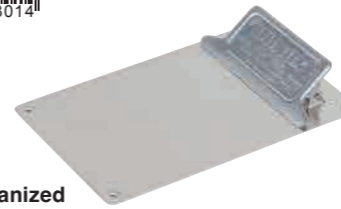

Galvanized
¥1,200+税
4 997337 733021



B5
Model 117-330B5
190×290mm



Brass
¥2,200+税
4 997337 733038



Galvanized
¥2,000+税
4 997337 733045



Package

A4
Model 117-330A4
220×340mm

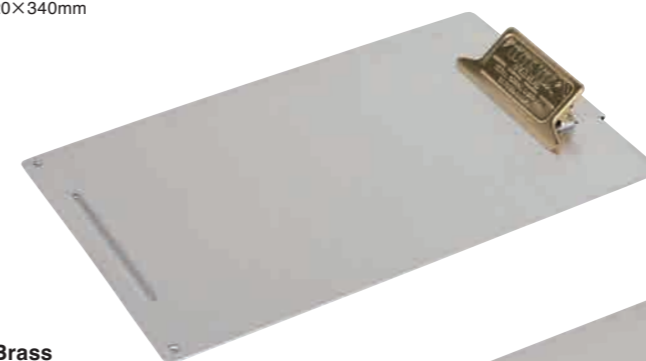

Brass
¥2,500+税
4 997337 733052



Package

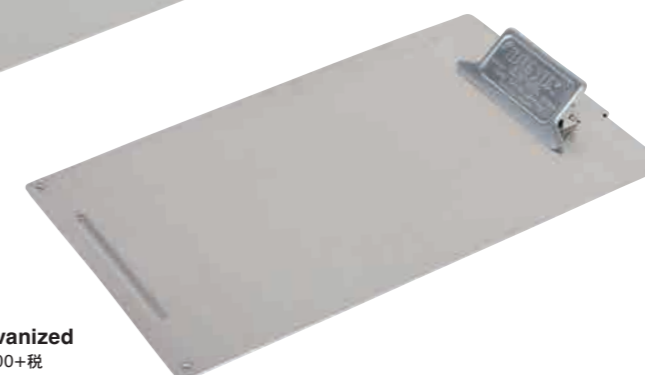

Galvanized
¥2,300+税
4 997337 733069



Brass



Galvanized





Metal clip
Model 117-329
46×117×33mm

材質：Brass (真鍮)
Galvanized, Color (スチール)



Color	Price	Barcode
● Brass	¥900+税	4 997337 732918
● Galvanized		4 997337 732925
● Ivory		4 997337 732932
● Red	¥500+税	4 997337 732949
● Yellow		4 997337 732956
● Olive drab		4 997337 732963



Package



6 colored clips



Red Yellow Olive drab

A
Model 118-345A
L.50mm / pc

Color	Price	Barcode
● Red		4 997337 845335
● Yellow	¥680+税	4 997337 845342
● Olive drab		4 997337 845373



◎1色6pcsセット



Galvanized Ivory Red
Yellow Olive drab

B
Model 118-345B
L.55mm / pc

Color	Price	Barcode
● Galvanized	¥380+税	4 997337 845410
● Ivory		4 997337 845427
● Red		4 997337 845434
● Yellow	¥680+税	4 997337 845441
● Olive drab		4 997337 845472



◎1色6pcsセット

Magnetic hook set of 2



Chrome Ivory Red Yellow Blue Dark green Black

Model B520-329
H.32 φ15mm
¥700+税



Color	Barcode
● Chrome	4 997337 032902
● Ivory	4 997337 032919
● Red	4 997337 032926
● Yellow	4 997337 032933

Color	Barcode
● Blue	4 997337 032957
● Dark green	4 997337 032964
● Black	4 997337 032995



◎1色2pcsセット



Magnet key storage

Model 121-375
H.68 W.105 D.30mm
Keyring 4 pcs
¥1,800+税
材質：スチール、アルミニウム、マグネット



Back



Galvanized
Model 121-375GV
4 997337 077569



Ivory
Model 121-375IV
4 997337 077583

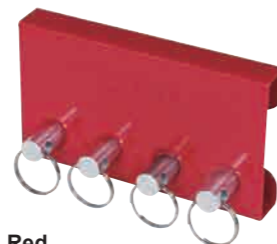

Red
Model 121-375RD
4 997337 077576

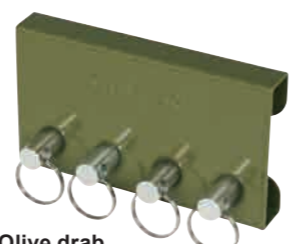

Olive drab
Model 121-375OV
4 997337 077590

◎壁に打ったビスなどに引っ掛けてご使用ください。
付属の両面テープで、ビスを打たずに設置も可能です。





Mini pegboard
 Model 120-363
 Pegboard H.300 W.200 D.10mm×2pcs
 材質：スチール、ステンレス
 付属品 ジョイント×2set

Color

- Raw ¥3,000+税 4 997337 069113
- Ivory 4 997337 069120
- Red 4 997337 069137
- Yellow ¥2,700+税 4 997337 069144
- Olive drab 4 997337 069175
- Navy 4 997337 069168
- H.gray 4 997337 069182



Raw



Ivory

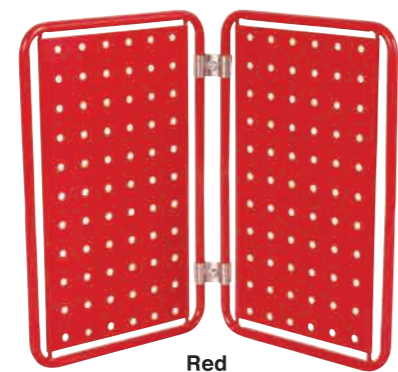

Red



Yellow

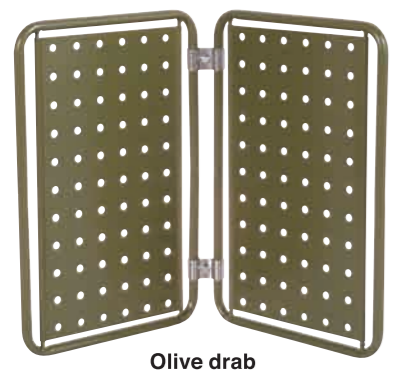

Olive drab

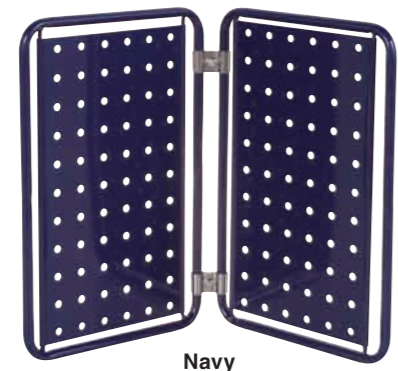

Navy



H.gray

Mini pegboard joint set
 Model 120-363J
 Pegboard H.300 W.200 D.10mm×1pc
 材質：スチール、ステンレス
 付属品 ジョイント×2set

Color

- Raw ¥1,800+税 4 997337 069199
- Red ¥1,500+税 4 997337 069229

◎Model 120-363の追加連結パーツセット



◎P341掲載のModel D19-0043にも連結可能です。



Mini fence
 Model D19-0043
 Fence H.305 W.200 D.9mm×2pcs
 付属品 ジョイント×2set
 ¥4,300+税 4 997337 058995



Mini fence joint set
 Model D19-0043J
 Fence H.305 W.200 D.9mm×1pc
 付属品 ジョイント×2set
 ¥2,800+税 4 997337 059008

◎P340掲載のModel 120-363にも連結可能です。



Desktop tray
 材質：スチール、アルミニウム
 205×95×22mm
 Inside 180×70×20mm
 ¥800+税
 LOT 3pcs



◎コーナーに1箇所、製造工程上必要な穴が空いています。あらかじめご了承ください。



Ivory
 Model 120-365IV
 4 997337 074971



Red
 Model 120-365RD
 4 997337 074988



Yellow
 Model 120-365YL
 4 997337 074995



Olive
 Model 120-365OV
 4 997337 075008



Navy
 Model 120-365NB
 4 997337 075015



Gray green
 Model 120-365GG
 4 997337 075022

Document box

Model 120-353
265×75×358mm
Inside 250×65×340mm
¥3,500+税

材質：スチール、ステンレススチール



Card

Title

DULTON

Yellow

- Color
- Raw 4 997337 074728
 - Ivory 4 997337 074735
 - Red 4 997337 074742
 - Yellow 4 997337 074773
 - Navy 4 997337 074766

◎付属の取り扱い説明書内のカードを切り取るとタイトルカードとしてご利用いただけます。



Magnetic memo bar long

Model Y926-1234
W.365mm
¥1,300+税

4 997337 912341



Magnetic memo bar

Model S026-20
W.185mm
¥1,000+税

4 997337 026208



Magnetic clip set of 5



Type-A

Model CH14-H495A
L.50mm/ pc
¥680+税

4 997337 144957



Type-B

Model CH14-H495B
L.55mm/ pc
¥680+税

4 997337 449526



Memo clip

Model CH02-M22S
H.40mm
¥400+税

4 997337 029223



Bolt and nut magnet set of 2

Model Y926-1235
H.28 W.17 D.20mm
¥1,000+税

4 997337 912358



4 Magnetic clips



Model TZ3160
50×20mm / each
¥1,100+税

4 997337 631600



Desktop basket

Model H20-0187
H.52 W.150 D.95mm
¥500+税

材質：ABS樹脂、スチール
LOT 6pcs



Red

- Color
- Ivory 4 997337 067683
 - Red 4 997337 067645
 - Yellow 4 997337 067652
 - Navy 4 997337 067669
 - Green 4 997337 067676
 - Gray 4 997337 067690
 - Sax 4 997337 067706
 - Orange 4 997337 067737
 - Mint green 4 997337 067713
 - Pink 4 997337 067720



Desktop wire stand

材質：スチール



Model RN-0442ZCM
H.230 W.110 D.35mm
¥550+税

4 997337 083126



Model RN-0442ZCL
H.225 W.158 D.37mm
¥600+税

4 997337 083140

Title clip



S

Model DC10-H49S
17×60×21mm
Card 15×52mm
¥140+税

◎タグは付属しません。

4 997337 310499



L

Model DC10-H49L
24×75×26mm
Card 21×67mm
¥160+税

◎タグは付属しません。

4 997337 410496

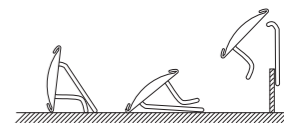

◎様々な設置方法が可能です。
(クリップ式、スタンド式)



Padded envelope bag

材質：HDPE、ポリエステル
 ◎完全防水ではありません。



Tablet

Inside



Yellow

Gray

White



13 inch laptop



15 inch laptop

Yellow

	Model	Size	Price	
Tablet	Y925-1247TB	H.230 W.165mm	¥1,400+税	4 997337 924719
13 inch laptop	Y925-1247LT13	H.340 W.260mm	¥1,900+税	4 997337 924726
15 inch laptop	Y925-1247LT15	H.382 W.285mm	¥2,000+税	4 997337 924733

Gray

	Model	Size	Price	
Tablet	Y925-1247TBGY	H.230 W.165mm	¥1,400+税	4 997337 087698
13 inch laptop	Y925-1247MGY	H.340 W.260mm	¥1,900+税	4 997337 087704
15 inch laptop	Y925-1247LGY	H.382 W.285mm	¥2,000+税	4 997337 087711

White

	Model	Size	Price	
Tablet	Y925-1247TBWT	H.230 W.165mm	¥1,400+税	4 997337 087728
13 inch laptop	Y925-1247MWT	H.340 W.260mm	¥1,900+税	4 997337 087735
15 inch laptop	Y925-1247LWT	H.382 W.285mm	¥2,000+税	4 997337 087742



Wax canvas tool pouch

材質：コットン100% (ワックス加工)、真鍮



S

H.155 W.250mm
 ¥1,000+税



Olive
 Model T21-0338S/OV
 4 997337 077033



Camel
 Model T21-0338S/CAM
 4 997337 077026

L

H.235 W.340mm
 ¥1,400+税



Olive
 Model T21-0338L/OV
 4 997337 077057



Camel
 Model T21-0338L/CAM
 4 997337 077040



Tool kit



Car service
Model K755-875
H.175 W.310 D.70mm
¥3,400+税
4 997337 758758

◎単3電池×4pcs使用。
◎電池は付属しません。

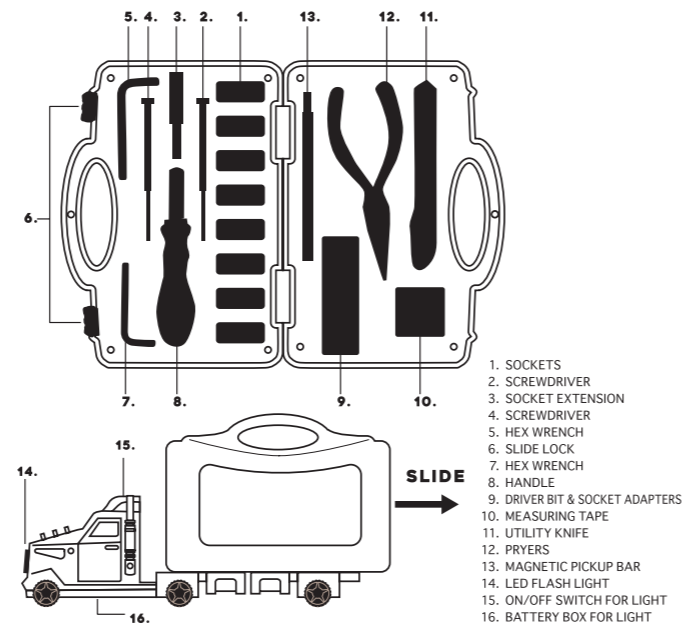

Package



Motor oil
Model R755-877
H.230 W.150 D.60mm
¥3,000+税
4 997337 758772

◎単4電池×4pcs使用。
◎電池は付属しません。



Package

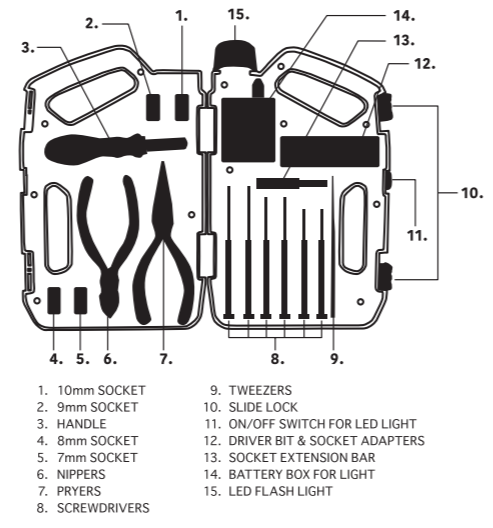

Military
Model K755-876OV
H.85 W.160 D.65mm
¥1,400+税
4 997337 787628

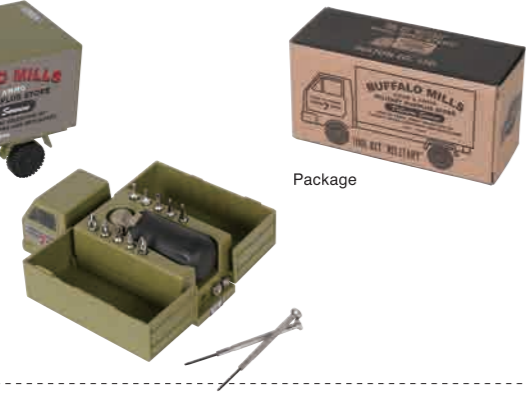

Package

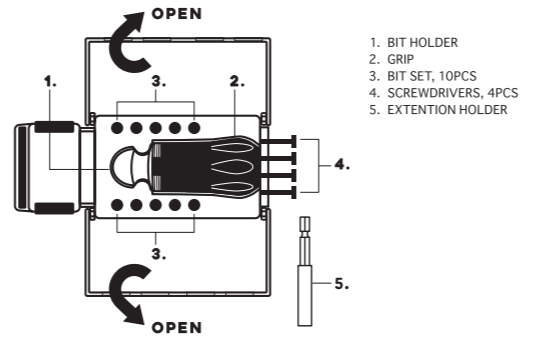

Delivery
Model K755-876NB
H.85 W.160 D.65mm
¥1,400+税
4 997337 787611

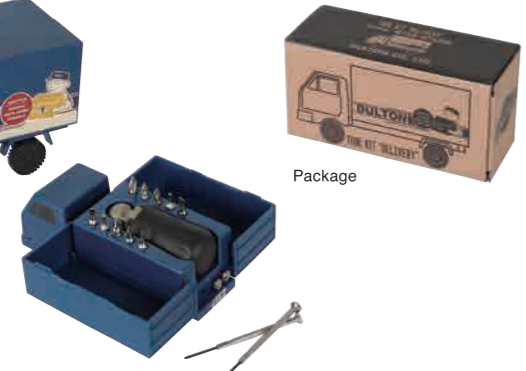

Package

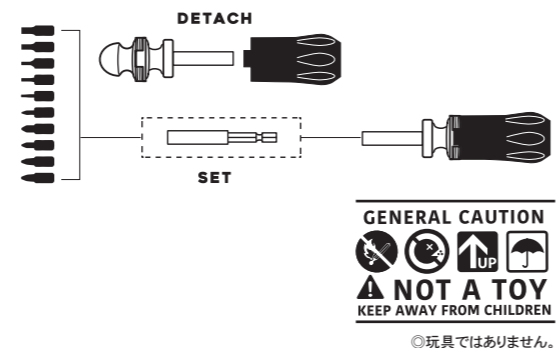

Tool key chain "Robot"

H.54 W.36 D.20mm
Chain L.52mm
¥680+税
LOT 6pcs

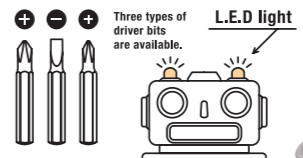

Package



Gray
Model K825-1064GY
4 997337 816410



Red
Model K825-1064RD
4 997337 816427



Navy
Model K825-1064NB
4 997337 816434

Section box

H.65 W.260 D.155mm
Inside H.40 W.75 D.145mm / each
¥750+税
材質：ポリプロピレン
LOT 3pcs



◎パーテーション取り外し可能



Dark green / Blue
Model H20-0127GN/BL
4 997337 063920



Gray / Yellow
Model H20-0127GY/YL
4 997337 063937

Light gray / Red

Model H20-0127GY/RD
4 997337 063913



Green / White
Model H20-0127GN/WT
4 997337 063944



Purple / Black
Model H20-0127PL/BK
4 997337 063951



Stash safe spray can

H.175 φ70mm
 ¥500+税
 材質：テンプレート、ポリプロピレン
 LOT 3pcs



De-icer
 Model H20-0176DI
 4 997337 067133



Fly ded
 Model H20-0176FD
 4 997337 067140



Machine oil
 Model H20-0176MO
 4 997337 067157



Blow jet
 Model H20-0176BJ
 4 997337 067164



Medi-quick
 Model H20-0176MQ
 4 997337 067171



Stash safe canned

H.110 φ75mm
 ¥600+税
 材質：テンプレート、ポリプロピレン
 LOT 3pcs



Beans
 Model H20-0177BN
 4 997337 067195



Lobster bisque
 Model H20-0177LB
 4 997337 067188



Pickles
 Model H20-0177PL
 4 997337 067201



Art ashtray

H.25 W.103 D.130mm
 ¥700+税
 材質：ポーセリン



Type-E
 Model G555-539ES
 4 997337 539111

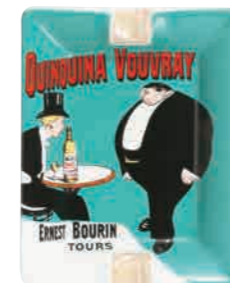

Type-K
 Model G555-539KS
 4 997337 539180



Type-L
 Model G555-539LS
 4 997337 086004



Type-M
 Model G555-539MS
 4 997337 086011



Type-N
 Model G555-539NS
 4 997337 086028



Type-P
 Model G555-539PS
 4 997337 086035



Type-Q
 Model G555-539QS
 4 997337 086042



Type-R
 Model G555-539RS
 4 997337 086059



Type-S
 Model G555-539SS
 4 997337 086066



Type-T
 Model G555-539TS
 4 997337 086073



Printed packing tape

Model PPT
5cm×50m
¥350+税
材質：OPP
LOT 6pcs



PPT-1
1 color
4 997337 018708



PPT-3
1 color
4 997337 018722



PPT-5
1 color
4 997337 018746



PPT-6
2 colors
4 997337 018753



PPT-7
2 colors
4 997337 018760



PPT-12
2 colors
4 997337 018807



PPT-21
2 colors
4 997337 066471



PPT-22
2 colors
4 997337 066486



PPT-23
2 colors
4 997337 066495

Glass block bank

材質：ガラス、ポリプロピレン



Square
Model H20-0192SQ
H.145 W.145 D.80mm
¥1,800+税



SIDE



投入口：40×3mm
キャップを外した
口径：φ45mm



Package



Glass sound expander

Model A555-532
H.260 W.133 D.135mm
¥6,200+税

4 997337 515016

◎製造工程上、若干の歪みやスジ、大きさや重量に多少の個体差が生じる場合があります。あらかじめご了承ください。

Bonox calculator

Model Y825-1056
H.38 W.113 D.176mm
¥2,400+税

4 997337 805711



Package



FASHION GLASSES

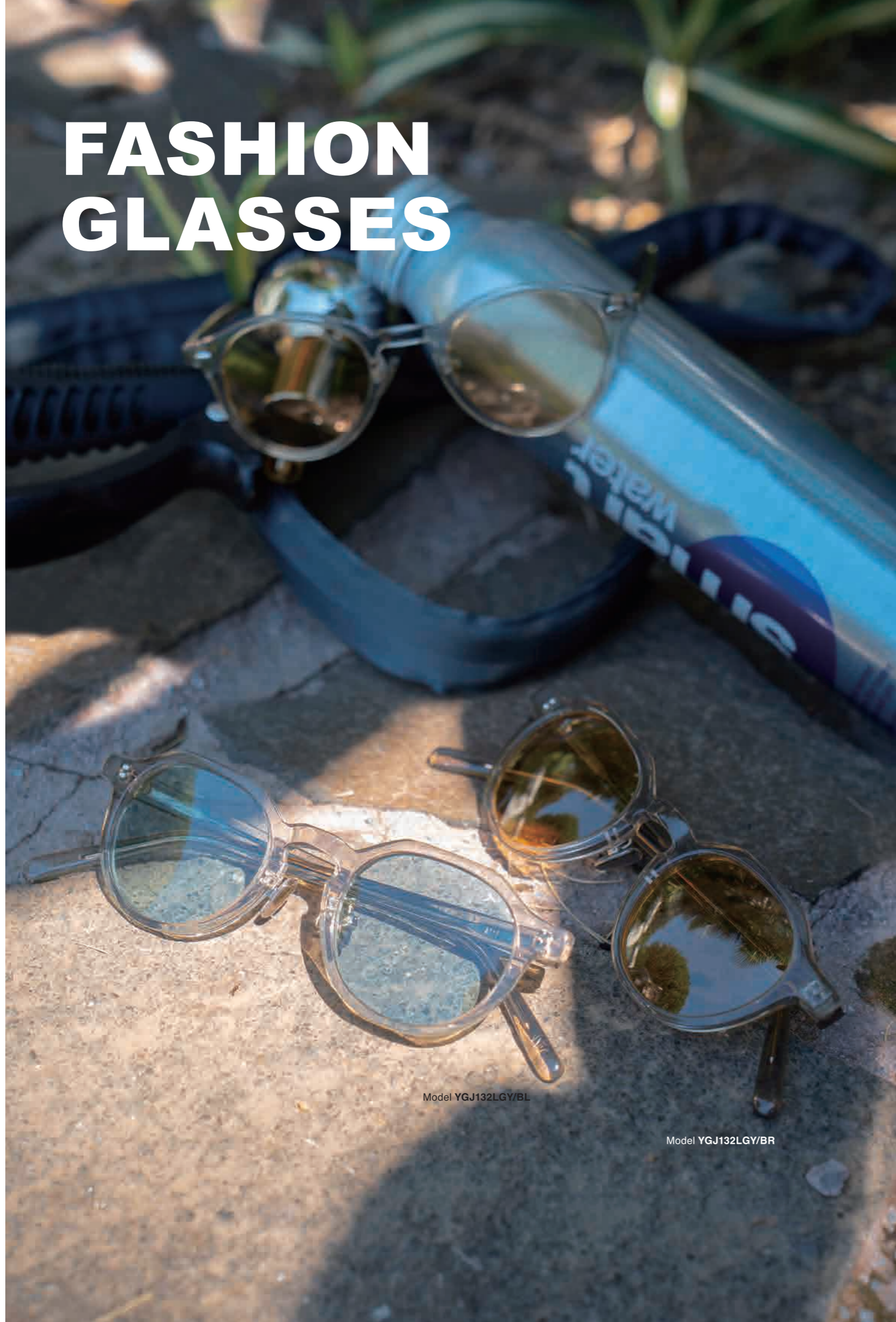

Model YGJ132LGY/BL

Model YGJ132LGY/BR

Model YGJ115 **UV**

¥2,800+税
フレーム：アセテート

紫外線透過率 1% 可視光線透過率
Blue lens 59%
Green lens 67%
Brown lens 59%



Black / Blue lens
Model YGJ115BK/BL
4 997337 089784



Black / Green lens
Model YGJ115BK/GN
4 997337 089777



Black / Brown lens
Model YGJ115BK/BR
4 997337 065238



Tortoise / Blue lens
Model YGJ115TO/BL
4 997337 065245



Tortoise / Green lens
Model YGJ115TO/GN
4 997337 089791



Tortoise / Brown lens
Model YGJ115TO/BR
4 997337 089807



Light gray / Blue lens
Model YGJ115LGY/BL
4 997337 089814



Light gray / Green lens
Model YGJ115LGY/GN
4 997337 065252



Light gray / Brown lens
Model YGJ115LGY/BR
4 997337 089821

Model YGJ132 **UV**

¥2,800+税
フレーム：アセテート

紫外線透過率 1% 可視光線透過率
Blue lens 59%
Green lens 67%
Brown lens 59%

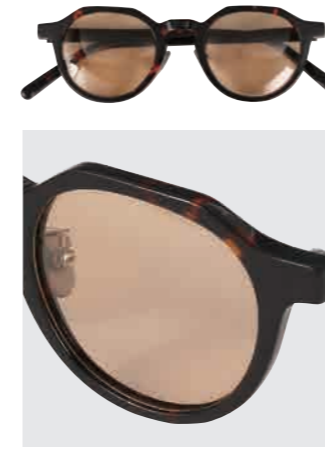

Black / Blue lens
Model YGJ132BK/BL
4 997337 089838



Black / Green lens
Model YGJ132BK/GN
4 997337 089845



Black / Brown lens
Model YGJ132BK/BR
4 997337 065085



Tortoise / Blue lens
Model YGJ132TO/BL
4 997337 065092



Tortoise / Green lens
Model YGJ132TO/GN
4 997337 089869



Tortoise / Brown lens
Model YGJ132TO/BR
4 997337 089852



Light gray / Blue lens
Model YGJ132LGY/BL
4 997337 089876



Light gray / Green lens
Model YGJ132LGY/GN
4 997337 065108



Light gray / Brown lens
Model YGJ132LGY/BR
4 997337 089883

GLASSES ACCESSORY



Folding case
Model CH13-S485
H.35 W.160 D.63mm
¥750+税



Light brown
4 997337 348553



Dark gray
4 997337 348591



Dark brown
4 997337 348560



Package

Denim glasses case
Model A325-118
H.43 W.163 D.60mm
¥800+税

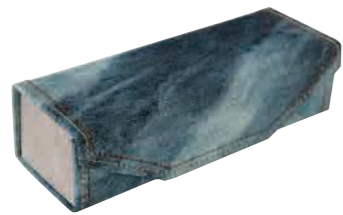

Dark blue
4 997337 511858



Light blue
4 997337 511841

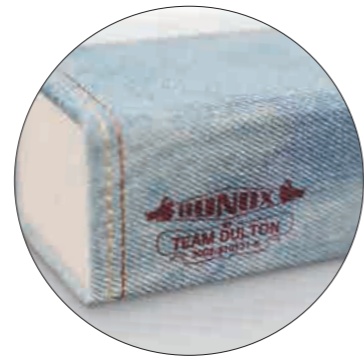

◎厚手生地のため、ご使用直後は生地が馴染んでおらず、折りたたみにくい場合があります。
数回「折りグセ」をつけることで生地が馴染んでいきます。
◎眼鏡の形状・サイズによっては収納できない場合があります。◎眼鏡は付属しません。

Glasses case "Mustang"
Model A625-787
H.70 W.175 D.35mm
¥800+税



Black
4 997337 578721



Red
4 997337 578738



Brown
4 997337 578745



Natural
4 997337 578752

Glasses case "Caravan"
Model A925-1251
H.75 W.170 D.40mm
¥900+税



Beige
材質：PULレザー、アイアン
4 997337 925518



Black
材質：PULレザー、アイアン
4 997337 925525



Brown
材質：PULレザー、アイアン
4 997337 925532



Navy
材質：PULレザー、アイアン
4 997337 925549



Red
材質：PULレザー、アイアン
4 997337 925556



Denim
材質：コットン、PULレザー、アイアン
4 997337 925563

◎眼鏡の形状・サイズによってはご使用できない場合があります。◎眼鏡は付属しません。

NEW ARRIVAL

CAR & OUTDOOR

FURNITURE

HOUSEWARE

GARDEN & GREEN

KITCHENWARE

SMALL SUNDRIES

DULTON GOODS

DULTON T-shirt oval logo



¥3,600+税
材質：コットン100%

S 着丈 63 / 身幅 51 / 肩幅 44cm
M 着丈 65 / 身幅 53 / 肩幅 46cm
L 着丈 67 / 身幅 55 / 肩幅 48cm
XL 着丈 69 / 身幅 57 / 肩幅 50cm



Front print

White

Black

Navy

Yellow

Color	Size S	Size M	Size L	Size XL
○ White	T22-0474S/WT 4 997337 084079	T22-0474M/WT 4 997337 084086	T22-0474L/WT 4 997337 084093	T22-0474XL/WT 4 997337 084109
● Navy	T22-0475S/NB 4 997337 084116	T22-0475M/NB 4 997337 084130	T22-0475L/NB 4 997337 084147	T22-0475XL/NB 4 997337 084161
● Black	T22-0476S/BK 4 997337 084178	T22-0476M/BK 4 997337 084185	T22-0476L/BK 4 997337 084192	T22-0476XL/BK 4 997337 084208
● Yellow	T22-0477S/YL 4 997337 084215	T22-0477M/YL 4 997337 084222	T22-0477L/YL 4 997337 084239	T22-0477XL/YL 4 997337 084246

DULTON Long T-shirt oval logo



¥4,500+税
材質：コットン100%

S 着丈 64 / 身幅 52 / 肩幅 43cm
M 着丈 66 / 身幅 54 / 肩幅 45cm
L 着丈 68 / 身幅 56 / 肩幅 47cm
XL 着丈 70 / 身幅 58 / 肩幅 49cm



Front print

White

Gray

Color	Size S	Size M	Size L	Size XL
○ White	T22-0459S/WT 4 997337 083690	T22-0459M/WT 4 997337 083706	T22-0459L/WT 4 997337 083775	T22-0459XL/WT 4 997337 083775
● Gray	T22-0459S/GY 4 997337 083560	T22-0459M/GY 4 997337 083577	T22-0459L/GY 4 997337 083584	T22-0459XL/GY 4 997337 083607



Mini wheel barrow
Model CH06-H271
H.60 W.130 D.60mm
¥880+税



Mini tool cart
Model CH07-H304
H.35 W.100 D.60mm
¥880+税



DULTON Wappen

Model 118-336
¥850+税



A) Company
93×96mm



B) Metal products
73×80mm



C) Delivery service
100×64mm



D) Botany
68×90mm



E) Hardware
75×73mm



DULTON Can case

Model 118-343
H.125 φ65mm
¥1,400+税



A



B



C



Package

CAR & OUTDOOR

FURNITURE

HOUSEWARE

GARDEN & GREEN

KITCHENWARE

SMALL SUNDRIES

INDEX

Index of Numbers

1		11990	310	CH14-G514	247	G21-0318	235	H20-0139	119
100-016	315	12000	310	CH14-G515	247	G21-0380	252	H20-0140	119
100-017	275	2		CH14-G516	261	G21-0383	251	H20-0143	119
100-029	278	2430	216	CH14-G517	261	G21-0384	246	H20-0144	217
100-053	206	4		CH14-H495	343	G21-0385	246	H20-0145	217
100-061	36, 272	405	216	CH14-H500	166	G21-0386	247	H20-0155	199
100-093	8, 121	45710	278	CH14-H501	166	G21-0387	247	H20-0176	348
100-104	278	46738	315	CH14-H502	166	G21-0388	251	H20-0177	348
100-105	176	5		CH14-H503	166	G21-0389	253	H20-0178	206
100-106	33, 176	5016A	279	CH14-H518	166	G21-0390	251	H20-0183	182
100-110	180	5017A	279	CH14-H519	166	G21-0394	262	H20-0184	182
100-126	36, 272	517210	310	CH14-H520	166	G21-0395	259	H20-0185	117
100-133	100	517220	310	CH14-H521	166	G3449	331	H20-0187	342
100-135	100	7		CH14-H522	166	G555-539	181, 349	H20-0192	351
100-146	175	7651	198	CH14-K492	265, 285	G603	329	H20-0206	198
100-156	177	7660	198	CH15-G527	261	G619-827	297	H20-0207	198
100-158	132	710860	309	CH15-H529	156	G619-828	296	H20-0244	207
100-160	194, 274	710870	309	CH99-W04	165	G619-829	296	H20-0246	204
100-164	101	710880	309	CK103	266	G619-830	297	H20-0248	198
100-165	101	9		CK1474	267	G655-750	209	H20-0255	197
100-168	177	9121	277	CK1878	266	G655-752	209	H20-0261	196
100-173	177	A		D		G659-831	297	H20-0263	180
100-189	36, 274	A325-118	354	D19-0040	128	G675-824	225	H20-0282	164
100-192	103	A515-299	303, 304	D19-0041	128	G675-825	223	H20-0283	164
100-195	175	A515-302	303, 304	D19-0042	128	G755-903	195	H20-0284	169
100-196	176	A515-543	295	D19-0043	129, 341	G755-904	195	H20-0285	170
100-198	175	A515-544	295	D19-0057	120	G755-905	195	H20-0298	227
100-207	122	A515-545	295	D19-0058	120	G755-906	195	H20-0299	172, 269
100-213	113	A555-426	263	D19-0059	120	G755-907	195	H21-0307	91
100-214	113	A555-532	229, 351	D20-0121	211	G815-966	292	H21-0309	269
100-226	163	A615-818	310	D20-0122	212	G855-1047	219	H21-0311	269
100-244	176	A625-787	355	D20-0209	336	G855-1070	267	H21-0313	269
100-252	129	A655-758	263	D20-0210	336	G855-1071	267	H21-0343	162
100-253	113	A659-601	240	D21-0328	210	G875-959	225	H21-0344	117
100-271	129	A659-602	240	D21-0329	210	G965-1245	153	H21-0351	161
100CLR	3	A715-867	311	D21-0330	211	G965-1246	153	H21-0362	203
100CLRP	3	A715-888	314	D21-0331	210	G975-1270	76	H21-0365	181
112-281	113	A925-1251	355	DC10-H49	343	G975-1271	76	H21-0366	193
113-288	122	AG-0424	114	DF-1651	285	GD-13	43	H21-0381	173
113-296	163	ALC0255	114	DS-0630	7	GD-14	43	H21-0382	173
113-298	158	ALC802C	114	DSZ-0504	121	GD-15	43	H22-0402	143
113-300	113	AS-0411	116	DSZ-0596	55	GM-0405	105	H23-0667	92, 160
115-322	103	AS-0551	32, 150	DT03-CF	123	GM-0473	148	H845-1022	126
116-323	133	B		DT18-CF	9, 123	GM-0608	51, 135	H845-1023	126
117-327	158	B520-329	339	DTCT-16	331	GM-0660	12, 149	H845-1024	125
117-329	338	B711-898	307	DTCT-19	330	GS555-266	229	H945-1254	125
117-330	337	B711-901	307	E		GZ-0626	52	HL4360	214
118-336	357	B911-1291	307	E20-0279	123	H		K	
118-342	273	BG023	227	E20-0280	123	H11907	279	K19-0093	196
118-343	357	BY-0421	224	F		H19-0022	209	K19-0098	289
118-345	339	BYR-0416	250	F19-0001	126	H19-0023	209	K19-0099	289
119-346	102	C		F19-0002	125	H19-0025	209	K19-0100	288
119-349	100	CH00-H05	285	F20-0179	134	H19-0026	209	K19-0101	288
120-353	342	CH01-K13	276	F20-0180	134	H19-0029	222	K19-0102	288
120-355	103	CH01-K14	283	F20-0181	134	H19-0030	222	K19-0103	288
120-356	102	CH02-K32	283	F20-0272	105	H19-0031	222	K19-0106	313
120-357	102	CH02-M22	343	F21-0333	142	H19-0032	222	K19-0106	313
120-358	132	CH03-H92	193	F21-0391	110	H19-0033	222	K19-0108	313
120-363	340	CH03-V76	268	F21-0396	86, 127	H19-0047	183	K19-0109	313
120-365	341	CH04-H116	193	F21-0397	86, 127	H19-0048	226	K19-0116	307
121-372	163	CH04-H117	193	G		H19-0049	226	K20-0119	307
121-374	70, 199	CH06-H271	356	G19-0006	262	H19-0078	240	K20-0123	284
121-375	338	CH07-H298	157	G19-0073	264	H19-0079	240	K20-0125	283
121-376	335	CH07-H304	356	G19-0076	265	H19-0080	240	K20-0124	284
121-377	335	CH10-H410	166	G19-0083	265	H19-0096	196	K20-0125	283
122-378	300	CH10-H411	199	G20-0195	262	H19-0097	196	K20-0126	283
122-379	99	CH10-H411	199	G20-0196	262	H19-0110	227	K20-0131	328
122-380	99	CH11-H415	166	G20-0196	262	H19-0111	222	K20-0132	328
123-384	35	CH11-H417	166	G20-0202	262	H19-0114	222	K20-0133	317
123-385	15, 152	CH11-H418	166	G20-0203	262	H19-0115	222	K20-0156	312
1001	285	CH12-H463	194	G20-0213	263	H20-0127	347	K20-0159	314
10320	310	CH13-G476	261	G20-0214	263	H20-0138	189	K20-0164	278
10330	310	CH13-H490	196	G20-0215	263			K20-0167	278
11810	310	CH13-S485	354	G20-0216	263			K20-0178	206
11960	310	CH14-G510	247	G20-0217	263			K20-0183	182
11970	310	CH14-G511	247	G20-0219	263			K20-0184	182
11980	310	CH14-G513	247	G20-0220	263			K20-0185	117

Index of Numbers

K20-0278	290
K20-0301	302
K20-0302	302
K20-0303	302
K20-304	289
K21-0308	276
K21-0321	301
K21-0322	301
K21-0323	301
K21-0324	301
K21-0339	315
K21-0339	315
K21-0340	314
K21-0341	293
K21-0341	293
K21-0342	277
K21-0354	295
K21-0356	319
K21-0357	320
K21-0358	321
K21-0359	323
K21-0360	326
K21-0361	235
K21-0363	275
K21-0379	285
K21-0393	278
K555-348	194
K555-425	178
K555-499	211
K555-502	211
K555-527	194
K565-477	246
K565-478	246
K655-657	229
K655-699	213
K655-702	214
K655-757	90, 180
K655-851	261
K655-852	261
K659-661	236
K725-923	202
K725-924	202
K725-925	202
K725-927	202
K755-875	346
K755-876	346
K755-876	346
K755-917	194
K755-920	195
K755-921	194
K825-1064	347
K855-1098	195
K855-1202	178
K855-1203	178
K855-1203	178
K855-1204	178
K865-1031	267
K865-1031	267
K865-1094	264
K865-1095	264
K915-1244	277
K915-1274	324
K915-1275	324
K915-1276	319
K915-1277	319
K915-1285	282
K915-1286	282
K915-1287	283
K925-1256	205
K925-1257	205
K925-1283	207
K925-1284	207
K955-1211	165
K955-1212	165
K955-1215	247
K955-1219	247
K955-1222	247

K955-1223	247
K955-1224	247
K955-1263	220
K955-1264	215
K955-1273	179
M	
M-0436	282
M-0445	275
M-0516	305
M-0516	305
M-0516	305
M-0517	309
M-0518	309
M-0519	306
M-0520	306
M-0521	284
M-0586	48
M-0587	48
M-0588	48
M-0589	48
M-0590	48
M-0591	47
M-0592	46
M-0593	48
M-0665	39
M-0666	37
M-0668	38
M411-216	311
M411-218	311
M411-254	313
M5029	313
M5030	313
MT-0407	129
MT-0524	141
MT-0525	141
MT-0526	140
MT-0531	145
MZ-0456	84
N	
N5004	279
N5005	279
N9020	283
N9021	283
N9022	283
N9023	283
NB-0406	255
NB-0458	250
NB-0461	258
NB-0462	258
NB-0465	248
NB-0466	248
NB-0467	248
NB-0468	248
NB-0469	248
NB-0543	254
NB-0602	260
NB-0605	59
NB-0606	59
NB-0607	247
NB-0628	43
NB-0641	17
NB-0642	17
NBN-0492	249
NBR-0583	253
NBR-0584	253
NBZ-0460	257
P	
PT120	175
PT240	175
R	
R615-737	281
R615-738	281
R615-844	330
R655-744	216
R655-745	216
R655-747	215
R655-794	181
R655-796	199
R755-877	346
R815-1006	39, 265, 314
R855-1008	214
R855-1009	213
R855-1043	228
R855-993	180
R855-994	216
RN-0399	220
RN-0400	150, 219
RN-0401	220
RN-0413	120
RN-0417	190
RN-0418	190
RN-0419	190
RN-0420	179
RN-0425	186
RN-0426	85, 293
RN-0427	187
RN-0428	188
RN-0429	186
RN-0430	187
RN-0431	187
RN-0442	220, 343
RN-0494	242
RN-0623	26
RN-0625	33
RN-0637	23
RN-0638	23
RN-0639	24
RN-0640	24
RN-0661	41
RN-0662	40
RN-0663	41
RN-0663	41
RN-0664	43
RNR-0470	189
RNR-0644	25
RNZ-0457	151
RNZ-0471	191
RNZ-0472	191
RNZ-0539	87
RNZ-0619	29
RNZ-0620	29
RNZ-0621	29
RNZ-0624	16, 152
RS23-0577	58
RS23-0658	59
RVG-0490	115
RVG-0491	108
RVG-0523	108
RVG-0578	50
S	
S015-51	308
S026-20	343
S115-12	277
S115-23	308
S115-24	308
S159-54	233
S175-34	193
S215-15	308
S215-16	308
S216-81	327
S245-86	115
S255-100	214
S255-101	214
S255-58	165
S255-88	214
S255-89	214
S255-90	214
S255-91	214
S255-92	214
S255-99	214
S310-106	315
S315-113	276
S315-114	276
S315-115	276
S315-122	308
S315-20	309
S315-21	309
S315-75	312
S355-107	214
S355-108	214
S355-39	153
S355-83	153
S355-85	213
S355-89	214
S355-91	214
S355-92	214
S355-93	214
S355-94	214
S355-99	229
S359-36	234
S359-49	163
S415-168	315
S415-169	315
S426-207	204
S455-174	216
S455-175	216
S455-180	216
S455-190	189
S459-187	299
S459-189	299
S459-234	234
S516-323	331
S555-353	213
S555-375	213
S555-376	213
S555-379	214
S624-659	203
S81126	312
S81533	277
S82429	203
S95545	227
SG1275	311
SG1408	311
SG1690	311
SG1945	312
SG457	311
SG794	312
SGJ67	268
SLF01	137
T	
T19-0071	298
T20-0224	243
T20-0226	243
T21-0337	169
T21-0338	172, 345
T22-0459	356
T22-0474	356
T22-0475	356
T22-0476	356
T22-0477	356
T23-0645	44
T23-0646	44
T23-0647	44
T23-0648	44
T23-0649	44
T23-0650	44
T23-0651	45
T23-0652	45
T23-0653	45
TD08-313	194
TZ3160	343
V	
V21-0346	20
V21-0347	20
V21-0349	75
V21-0350	73
V21-0355	65
V21-0364	73
V21-0367	72
V21-0368	71
V21-0409	65
V21-0410	76
V22-0398	74
V22-0435	70
V22-0505	20
V23-0536	68
V23-0537	68
V23-0538	69
V23-0657	19
X	
XP-001	146
XP-020	147
XP-055	136
XR22-0433	219
XR22-0434	219
XR23-0530	190
XR23-0544	88
XR23-0579	228
XR23-0580	228
XR23-0585	228
XRZ-0441	82
XRZ-0603	83
XT-708	198
Y	
Y-0443	85, 289
Y-0444	81, 127
Y-0447	143
Y-0506	230
Y-0507	230
Y-0508	230
Y-0509	230
Y-0510	230
Y-0511	230
Y-0512	230
Y-0513	230
Y-0514	230
Y-0515	230
Y-0532	56
Y-0533	56
Y-0534	56
Y-0535	56
Y-0604	54
Y-0609	57
Y-0610	57
Y-0611	57
Y-0612	57
Y-0613	57
Y-0614	57
Y-0615	57
Y-0616	57
Y-0617	57
Y-0631	30
Y-0632	30
Y-0633	30
Y-0634	30
Y-0635	30
Y-0636	30
Y825-1056	351
Y915-1253	280
Y915-1253	280
Y915-1282	327
Y925-1247	345
Y926-1234	343
Y926-1235	343
Y955-1249	213
Y959-1265	168, 297
Y959-1266	168
Y959-1267	168
YGJ115	353
YGJ132	353
YR-0423	107
YR-0522	106
YR-0643	11
YZ-0408	90
YZ-0432	81
YZ-0618	53

Index of Numbers

R655-796	199
R755-877	346
R815-1006	39, 265, 314
R855-1008	214
R855-1009	213
R855-1043	228
R855-993	180
R855-994	216
RN-0399	220
RN-0400	150, 219
RN-0401	220
RN-0413	120
RN-0417	190
RN-0418	190
RN-0419	190
RN-0420	179
RN-0425	186
RN-0426	85, 293
RN-0427	187
RN-0428	188
RN-0429	186
RN-0430	187
RN-0431	187
RN-0442	220, 343
RN-0494	242
RN-0623	26
RN-0625	33
RN-0637	23
RN-0638	23
RN-0639	24
RN-0640	24
RN-0661	41
RN-0662	40
RN-0663	41
RN-0663	41
RN-0664	43
RNR-0470	189
RNR-0644	25
RNZ-0457	151
RNZ-0471	191
RNZ-0472	191
RNZ-0539	87
RNZ-0619	29
RNZ-0620	29
RNZ-0621	29
RNZ-0624	16, 152
RS23-0577	58
RS23-0658	59
RVG-0490	115
RVG-0491	108
RVG-0523	108
RVG-0578	50
S	
S015-51	308
S026-20	343
S115-12	277
S115-23	308
S115-24	308
S159-54	233
S175-34	193
S215-15	308
S215-16	308
S216-81	327
S245-86	115
S255-100	214
S255-101	214
S255-58	165
S255-88	214
S255-89	214
S255-90	214
S255-91	214
S255-92	214
S255-99	214
S310-106	315
S315-113	276
S315-114	276
S315-115	276
S315-122	308
S315-20	309
S315-21	309
S315-75	312
S355-107	214
S355-108	214
S355-39	153
S355-83	153
S355-85	213
S355-89	214
S355-91	214
S355-92	214
S355-93	214
S355-94	214
S355-99	229
S359-36	234
S359-49	163
S415-168	315
S415-169	315
S426-207	204
S455-174	216
S455-175	216
S455-180	216
S455-190	189
S459-187	299
S459-189	299
S459-234	234
S516-323	331
S555-353	213
S555-375	213
S555-376	213
S555-379	214
S624-659	203
S81126	312
S81533	277
S82429	203
S95545	227
SG1275	311
SG1408	311
SG1690	311
SG1945	312
SG457	311

INDEX

Alphabetical Index

0~	B	COTTON CHINDI RUG / MAT	238	FILE BOX	336
1 MILE TOTE BAG	169	BABY GARBAGE CAN	176	COTTON HALF MESH BAG	298
12 PARTITION WOODEN BOX	166	BABY SMILLY	177	COTTON HANDLOOM MAT	241
2 BRANCH HOOK	214	BAMBOO MAGNETIC TOOL HOLDER	209	COTTON ROPE MAT	239
2 COLUMNS BY 5 DRAWERS	101	BAR	212	CUBE JAR WITH PRESS LID	282
2 IN 1 JUMBO FUNNEL WITH STRAINER	277	BAR STOOL	115	CUBE SPICE JAR	283
2 LAYER CABINET	100	BASKET TROLLEY	163	CUP BOARD	99
2 SWING WALL HOOK	214	BEER BENCH	86, 127	CURVED SPICE JAR	283
2-COMPARTMENT BIN	178	BEER TABLE	86, 127	CUTLERY REST	330
3 COLUMNS BY 5 DRAWERS	101	BELT BRACKET	213	CYLINDER JAR WITH PRESS LID	282
3 PARTITION WOODEN BOX	166	BELT BRACKET WITH RING	213	D	
3-COMPARTMENT BIN	178	BEVERAGE SERVER	311	D.M.S "GARAGE" 6L / 16L	158
304 STAINLESS STEEL BOWL	277	BIRCH WOOD LED CANDLE	228	DECK BRUSH	182
35PCS PP CLOTHESPIN IN BOTTLE	187	BIRCH WOOD LOG CANDLE	228	DEEP TRAY MAT	68
3 LAYERS SPONGE	187	BIRCH WOOD STUMP CANDLE	228	DENIM GLASSES CASE	354
4 MAGNETIC CLIPS	343	BIRD TOOTHPICK SERVER	327	DENIM RUG / MAT	240
4 TIER TAPERED METAL SHELF	133	BLOWER&BRUSH	247	DENT CUTLERY	328
4-HOLES TOOTHBRUSH HOLDER	193	BOHUMIL CLOCK	205	DENTAL FLOSS	193
5 DRAWERS CHEST	100	BOLT AND NUT MAGNET	343	DESKTOP BASKET	342
5 LAYER CABINET WITH DRAWER	99	BONOX CALCULATOR	351	DESKTOP TRAY	341
6 BOTTLES SPICE RACK	283	BOOK SHELF	136	DESKTOP WIRE STAND	220, 343
6 COLORED CLIPS	339	BORMIOLI BODEGA	309	DIBBER	247
6 PARTITION WOODEN BOX	166	BOTANY LONG POT	260	DIET SCALE	36, 272
8 PARTITION WOODEN BOX	166	BOTANY POT	259	DINING TABLE	146
A		BOTANY STAINLESS TOOL SET	247	DISPLAY BOX	43
ACACIA CUTLERY CASE / STAND	313	BOTANY T-SHIRT	45	DOCUMENT BOX	342
ACACIA CUTTING BOARD	313	BOTANY WORK GLOVES	249	DOER'S BOOKSHELF	50
ACACIA TRAY WITH METAL HANDLE	313	BOTTLE FOR SPICE RACK	283	DOER'S CHAIR	115
ACACIA WOOD COFFEE SPOON	314	BOTTLE TISSUE	73	DOER'S DESK	108
ACACIA WOOD COMPORT	312	BOW BRACKET	213	DOER'S DINING TABLE	108
ACRYLIC BLANKET	236	BOWL WITH RUST RIM	301	DOOR HANDLE	211
ADJUSTABLE BRACKET	213	BOWL WITH WHITE RIM	301	DOUBLE FACE CLOCK 170D	203
AIR FRESHENER	75	BRACKET	213	DOUBLE FACE CLOCK 170D2	11
AIRTIGHT JAR	285	BRANCH BAG	251	DOUBLE FACE CLOCK RECTANGLE	203
ALARM CLOCK	206	BRASS SIGN	216	DOUBLE FACES WALL CLOCK	203
ALOE FRAGRANCE DIFFUSER	225	BRUSH PEN	247	DOUBLE LEVER SOMMELIER KNIFE	39
ALUMI CONTAINER "CONVOY 2" RL	92, 160	BULL SKULL HOOK	214	DOUBLE SWING WALL HOOK	214
ALUMI TRIVET HOT-DIN	275	BUTTER KNIFE "COLON"	317	DOUBLE WALLED BOTTLE COOLER	306
ALUMINUM BAR STOOL	114	BUTTER KNIFE FISH	331	DOWNROD	123
ALUMINUM STANDARD CHAIR	114	C		DR. CABINET	132
ALUMINUM ARM CHAIR	114	CACTUS	229	DULTON CAN CASE	357
ALUMINUM BAR HANDLE	211	CACTUS FRAGRANCE DIFFUSER	225	DULTON FOLDING CONTAINER	162
ALUMINUM BRACKET	56	CAKE PLATE WITH RUST RIM	301	DULTON LONG T-SHIRT	356
ALUMINUM BREAD TRAY	277	CAKE PLATE WITH WHITE RIM	301	DULTON MUG	300
ALUMINUM CAFE CHAIR	126	CAKE STAND PLEATS PLATE	312	DULTON SIGN STAND	151
ALUMINUM CAFE TABLE	125	CANDLE HOLDER GLASSBALL	227	DULTON T-SHIRT	44, 356
ALUMINUM CEILING RACK	278	CANVAS ART	219	DULTON TRAY STAND	16, 152
ALUMINUM CHAIR	114	CANVAS DIRECTOR CHAIR	52	DULTON WAPPEN	357
ALUMINUM CLIP LAMP	7	CAR FRAGRANCE	76	DURALEX MEASURING JUG	279
ALUMINUM CLOTHES HANGER	199	CARREBOWL	283	DURALEX PICARDIE	310
ALUMINUM DOOR HANDLE	56	CARRY SNACK TUB WITH TUMBLER	327	DUST BIN "TAMBOR"	194
ALUMINUM DOUBLE HOOK	56	CATS HOOK	214	DUST BIN SATIN FINISHED	178
ALUMINUM FOLDING CHAIR	81, 127	CEILING HOOK	214	DUST BRUSH SET	181
ALUMINUM LAMP SHADE	55	CEILING RING	214	DUSTPAN & BROOM	182
ALUMINUM POT WITH SAUCER	258	CEILING S-HOOK	214	DUSTPAN AND BRUSH	181
ALUMINUM ROUND TABLE	125	CELLULOSE CLOTH	185	E	
ALUMINUM ROUNDISH CHAIR	126	CEMENT ORGANIZER ASHTRAY	180	EM APRON	296
ALUMINUM SAUCER	258	CEMENT ORGANIZER SOAP DISH	196	EMERGENCY BAG	173
ALUMINUM SCOOP	265, 285	CEMENT POT	263	EMERGENCY POUCH	173
ALUMINUM SINGLE HOOK	56	CERAMIC POT	262	ENAMEL CUTLERY	289
ALUMINUM SOCKET CORD	121	CHAMBRAY KITCHEN CLOTH	299	ENAMELED BOWL	288
ALUMINUM TRAY	277	CHARCOAL DEODORANT BAG	73	ENAMELED DEEP PLATE	288
ALUMINUM WALL RACK	209	CHENILLE HANDLOOM MAT	242	ENAMELED FLOWER VASE	269
ALUMINUM WALL SHELF	209	CHUNKY DESSERT PLATE	302	ENAMELED MUG	289
ALUMINUM WALL SHELF	209	CHUNKY DINNER PLATE	302	ENAMELED NOTICE SIGN	217
ALUMINUM WISHBONE RACK	275	CIRCULAR BAG	251	ENAMELED PLATE	288
AMERICAN KITCHEN SCALE	36, 272	CLASSIC BOTTLE OPENER	315	ENAMELED SIGN	217
APRON W/RIBBON	26	CLASSIC-GENTLE SCALE	273	ENAMELED SOAP DISH	196
AQUA GLASS "FLEUR DE LIS"	309	CLOTH RACK HOOK	214	ENAMELED TUMBLER	196
AQUA GLASS "MARGUERITE"	308	CLOTHES BRUSH	199	ENAMELED UTENSIL POT	196
AQUA GLASS "FERN"	309	COFFEE MILL "TERRA"	314	ENAMELED WASHBOWL	196
AROMA DIFFUSER DAHLIA	226	COLOR GLAZED POT	261	EXTENDING MIRROR	195
AROMA DIFFUSER HYDRANGEA	226	COLOR GLAZED POT COVER	262	F	
ART ASHTRAY	181, 349	COLOR GLAZED SAUCER	261	FAKE TRIGGER BOTTLE	197
ART FRAME	219	COLOR SWATCH	3	FEATHER DUSTER	189
ASTRONAUT GLASSES HOLDER	43	COOLER BAG	19	FELT BANNER	87
AUTO SUNSHADE	65	CORDUROY SLIPPERS	243	FIBER LADDER	54
				HAMMOCK TOTE	29
				HAND FORK	247
				HAND SCOOP	247
				HAND TROWEL	247

HANDLE	211	METAL CHALKBOARD	215	RECTANGLE MIRROR WITH TRAY	195	STANDARD CHAIR	113
HANGING BRACKET	213	METAL CLIP	338	RECTANGLE STAND MIRROR	195	STASH SAFE CANNED	348
HANGING SIGN	215	METAL CLIPBOARD	337	RECTANGLE TRIVET	276	STASH SAFE SPRAY CAN	348
HIGH PRESSURE GARDEN HOSE	250	METAL FRAME	220	REFILL BOTTLE	59	STEEL FRAME MIRROR W/PEGBOARD	12,149
HONEYCOMB WINE RACK	307	METAL TOOL CART	134	REMOTE CONTROLE & RECEIVER SET	123	STEEL SHELF 3 LAYER	134
I		METAL WINE RACK	307	REPOT SHEET	253	STEEL SHELF 5 LAYER	134
ICE CHEST 20L	81	MEXICAN THROW	235	REVERSIBLE SIGN	216	STONE DIFFUSER	224
IRON ASHTRAY	180	MICRO GARBAGE CAN	176	REVERSIBLE SIGN STAND	216	STOOL "CLIPPER II"	113
IRON BOOTS BRUSH	253	MICROFIBER BLANKET	71	RIGHT DIRECTION	214	STORE WAGON	145
IRON CANDLE HOLDER	227	MICROFIBER CLOTH	72	ROTATING RACK	43	STRING HOLDER	229
IRON CANDLE STAND	227	MICROFIBER TABLE WIPES	190	ROUGHLY BAG	297	SVELTE CUTLERY	330
IRON HOOK	214	MINI FENCE	129, 341	ROUND COFFEE TABLE	148	SWING CONVERTIBLE TABLE & SHELF	51,135
IRON SIGN	216	MINI GARBAGE CAN	176	ROUND HEAD PRUNER	246	SWING STAND MIRROR	195
IRON TRIVET OBLONG	276	MINI KITCHEN TOOL SET	278	ROUND POT	262	T	
ITALIAN BASIN	190	MINI PARTS BOX	156	ROUND STAND MIRROR	195	TABLE DOUBLE GLASS FRAME STAND	220
ITALIAN BUCKET	190	MINI PEGBOARD	340	ROUND TABLE	147	TABLE ORGANIZER	35
ITALIAN OPEN WASTE BASKET	179	MINI RAKE	247	ROUND TRIVET	276	TABLE TOP MIRROR	222
J		MINI TOOL CART	356	RUBBER PARKING CURB	129	TEA INFUSER AT SEA DAY	315
JACQUARD MULTI CLOTH	236	MINI TRIANGLE CABINET	102	RV COASTER 4SET	297	TEA INFUSER T.FISHERMAN	315
JUMBO JAR	285	MINI TROWEL	247	S		TEA MEASURE SPOON	315
K		MINI WHEEL BARROW	356	S/10 STAINLESS STEEL CLOTHESPIN	186	TERRACOTTA BICOLOR POT	262
KANTINE CUTLERY	328	MINI Z RACK	117	S/2 COASTER ROUND	41	TERRACOTTA MUG	300
KITCHEN CLOTH	299	MIRROR WITH STEEL FRAME	120	S/3 ALUMINUM HANGER	25	THE BLUE WHALE	59
KITCHEN STOOL	113	MOSQUITO COIL HOLDER	91	S/3 SS BAG CLIP	85, 293	THE GULLS	59
KITCHEN TIMER WITH MAGNET	36, 274	MUG INFUSER W/DOUBLE-USE TRAY	314	S/3 WAFFLE INDIE HAND TOWEL	191	THERMO-HYGROMETER	207
L		MUG WITH RUST RIM	301	S/5 STAINLESS STEEL CLOTHESPIN	186	TIN BASKET	82, 83
L.E.D LANTERN	228	MUG WITH WHITE RIM	301	SECTION BOX	347	TIN TRAY STAND	311
LAMBSWOOL DUSTER	188	MULTI CLOTH	233	SHARP HEAD PRUNER	246	TINY KITCHEN TOOL	278
LAND SERIES	46, 47, 48	MULTI CLOTH SOLID COLOR	234	SHOEHORN	198	TISSUE DISPENSER	194, 274
LAUNDRY CART	119	MW WORK APRON	296	SILVER POT WITH LEGS	262	TITLE CLIP	343
LAUNDRY MESH BAG	23	N		SINGLE HOOK	198	TOOL KEY CHAIN "ROBOT"	347
LAUNDRY TROLLEY	119	NONIX	310	SINGLE LADLE STAND	276	TOOL KIT	346
LAUNDRY WASH BAG	24	O		SINGLE SPIN CANVAS BLADES	9, 123	TOWEL BLANKET	88
LEAF BAG	251	OIL & VINEGAR BOTTLE	281	SLANTING WIRE RACK	164	TOWEL HOLDER	193
LEFT DIRECTION	214	ON THE ROCKS DIFFUSER	58	SLIDING DUST BOX	179	TOWEL RING	198
LIGHT-45 STOOL	113	ONE STEP	70	SLIPPERS COMBI	242	TRASH CAN DOUBLE DECKER	100
LIGHTING KIT	123	OPEN-CLOSED SIGN STAND	15, 152, 153	SMALL CHUNKY BOWL	302	TRIANGLE CABINET	132
LINK TUBE VASE	268	OVAL TRIVET	276	SMALL DOUBLE HOOK	214	TRIANGLE HOOK	211
LITTLE FISHES	30	P		SMALL SINGLE HOOK	214	TROWEL	247
LITTLE GEM FRAGRANCE DIFFUSER	225	PACKING TAPE	350	SMILLY SET LONG HANDLE	177	TUBE SQUEEZER WITH STAND	193
LITTLE JUG/VASE	37	PADDED ENVELOPE BAG	345	SOIL BUCKET	252	TWISTED STRING	229
LITTLE WINDMILL	255	PAPER HOLDER	198	SOLAR NEON LIGHT	254	U	
LIZARD HOOK	214	PARTITION STORAGE	336	SOLID PLANTER	263	URETHANE KITCHEN SPONGE	187
LOCKER 65	102	PARTS STOCKER	157	SOMMELIER KNIFE	307	UTILITY RACK	116
LOW CABINET	103	PEGBOARD DISPLAY RACK	142	SON OF SMILLY	177	V	
LOW TABLE	103	PENDANT LAMP WITH GLASS	8, 121	SOUP PLATE WITH RUST RIM	301	VANDULE CUTLERY	331
LUNAR VASE	267	PINCH HANGER	186	SOUP PLATE WITH WHITE RIM	301	VASE	268
M		PLACE MAT	40, 41, 297	SPARE BLADES SET OF 4	9, 123	W	
M&B 8 PLATE	324	PLAID PRINT TABLECLOTH	84	SPICE JAR WITH ROTATION LID	283	WAFFLE INDIE TOWEL	191
M&B BOWL	319	PLASTIC RAKE	248	SPICE JAR WITH SPOON	281	WALL CLOCK	204
M&B DEEP PLATE	321	PLASTIC TRANSPLANTER	248	SPINNER SIGN STAND OPEN-CLOSED	153	WALL CLOCK "BRISTOL"	202
M&B GRIP CUP	319	PLASTIC TRASH CAN	175	SPRAY BOTTLE PRO	189	WALL CLOCK "NORTHROP"	202
M&B KIDS PLATE SET	324	PLASTIC TROWEL	248	SQUARE ALARM CLOCK	206	WALL HANGING MIRROR	222
M&B MIXING BOWL	326	PLASTIC WEEDER	248	SQUEEGEE	188	WALL HOOK	214
M&B SERVING TRAY	235	PLASTIC WEEDING HOE	248	SS EXTENSIBLE TRIVET	275	WALL LAMP GLASS STICK	122
M&B SHALLOW PLATE	323	PORCELAIN BIG SOAP DISH	57	SS FOOD CONTAINER	284	WALL MOUNT SPINNER SIGN	153
M&B SQUARE PARTITION TRAY	320	PORCELAIN HOOK	57	SS FRAME MIRROR WITH BRACKET	120	WATERING CAN	250
M&B STANDARD CUP	319	PORCELAIN JUG	38	SS MEASURING SCOOP	278	WAVE HOOK	214
MAGAZINE RACK	165	PORCELAIN ROBE HOOK	57	SS RIM ENAMELED MUG	85, 289	WAX CANVAS FIELD CLOTH	89, 171
MAGNET KEY STORAGE	338	PORCELAIN SHELF	57	STACKABLE DRAWER	335	WAX CANVAS LOG BAG	168
MAGNETIC CLIP	343	PORCELAIN SINGLE HOOK	57	STAINLESS COLLECTION CASE	32, 150	WAX CANVAS LUNCH BAG	168, 297
MAGNETIC CLOCK	207	PORCELAIN SOAP DISH	57	STAINLESS COMBO PLATE	292	WAX CANVAS MULTIPURPOSE TOOL	168
MAGNETIC HOOK	339	PORCELAIN TOILET PAPER HOLDER	57	STAINLESS DRIP/WATER POT	39, 265, 314	WAX CANVAS TOOL BAG	169
MAGNETIC MEMO BAR	343	PORCELAIN TOWEL BAR	57	STAINLESS DRUM	90	WAX CANVAS TOOL POUCH	172, 345
MAGNETIC SOAP HOLDER	194	PORCELAIN TOWEL RING	57	STAINLESS FIELD CUTLERY	291	WEEDER	247
MAGNETIC STAND	220	PORTABLE ASHTRAY	90, 180	STAINLESS JAR WITH PRESS LID	282	WINDPROOF CLIP ASHTRAY	180
MARKET BASKET	165	PP CUTTING BOARD	280	STAINLESS MIRROR WITH BRACKET	209	WIRE MAGAZINE RACK	165
MASTER SOFA	105	PRESENTATION BASKET/STRAINER	293	STAINLESS MAGNETIC TOOL HOLDER	209	WIRE RACK	141
MEASUREGLASS	279	PRINTED MULTI CLOTH	234	STAINLESS PITCHER	265	WIRE RACK WITH CASTORS	164
MEASURING SPOON SET OF 5	278	PRUNING SCISSORS	246	STAINLESS PRUNER	246	WIRE ROUND RACK	141
MELAMINE MESS BOWL	290	PU SLIPPERS	243	STAINLESS SINK	143	WIRE SHELF	140
MELAMINE MESS CUP	290	PVC COIL MAT	240	STAINLESS STEEL CABINET	120	WOODEN BOX	163
MELAMINE MESS TRAY	290	PVC MAT	240	STAINLESS STEEL SOAP DISPENSER	194	WOODEN CABINET W/CASTORS	163
MEMO CLIP HOLDER	343	PYRAMID RUNNER MAT	69	STAINLESS STEEL TUMBLER	194	WOODEN CABINET WITH LAYER	163
MESH POUCH	23	R		STAINLESS STEEL WINE GLASS	306	WOODEN ORGANIZER BOX	166
METAL BOX	33	RAILROAD BLANKET	53	STAINLESS TABLE & BENCH	125	WOODEN ORGANIZER BOX	166
METAL BRUSH	247	RAINARD CLOCK	205	STAINLESS WORK BENCH	143	WOODEN STACKING BOX	166
				STANDARD BAR CHAIR	113	WORKER BAG	170

WORKING DESK	111
WRIGHT COFFEE TABLE	106
WRIGHT DINING TABLE	107
Z	
Z RACK	117

Order form

Page —

DATE _____

COMPANY NAME _____

	ITEM	MODEL No.	COLOR/SIZE	QTY	PRICE
1					
2					
3					
4					
5					
6					
7					
8					
9					
10					
11					
12					
13					
14					
15					
16					
17					
18					
19					
20					

MEMO

SHIZUOKA OFFICE
FAX. 054-267-6575
TEL. 054-267-6565
11-5 Naganuminami, Aoi-ku,
Shizuoka-shi, SHIZUOKA

TOKYO OFFICE
FAX. 03-3760-0756
TEL. 03-3760-0755
2-6-13 Gohongi, Meguro-ku, Tokyo

OSAKA OFFICE
FAX. 06-6910-5731
TEL. 06-6910-5730
1-2-4 Uchihirano-machi, Chuo-ku, Osaka

※本カタログ及びホームページから写真を転載・引用される場合は弊社営業担当者にご連絡ください。

株式会社 ダルトン

■静岡オフィス	〒420-0814	静岡県静岡市葵区長沼南11-5	TEL.054-267-6565	FAX.054-267-6575
■東京オフィス	〒153-0053	東京都目黒区五本木2-6-13	TEL.03-3760-0755	FAX.03-3760-0756
■DULTON SHOW CASE JIYUGAOKA	〒152-0034	東京都目黒区緑が丘2-25-14 DULTON JIYUGAOKA 3F		
■大阪オフィス	〒540-0037	大阪府大阪市中央区内平野町1-2-4 4F	TEL.06-6910-5730	FAX.06-6910-5731
■DULTON JIN-NAN	〒150-0041	東京都渋谷区神南1-4-8	TEL.03-5728-2552	FAX.03-5728-2553
■DULTON JIYUGAOKA	〒152-0034	東京都目黒区緑が丘2-25-14	TEL.03-6421-4875	FAX.03-6421-4876
■DULTON MARKET STORE GRANDBERRY PARK	〒194-8589	東京都町田市鶴間3-4-1 グランベリーパーク 1F	TEL.042-850-7223	FAX.042-850-7229
■D.F.SERVICE MACHIDA	〒194-0004	東京都町田市鶴間7-6-1	TEL.042-788-3480	FAX.042-788-3490
■D.F.SERVICE MUSASHI-MURAYAMA	〒208-0023	東京都武蔵村山市伊奈平2-34-1	TEL.042-569-7880	FAX.042-569-7881
■ZAPADY-DOO	〒150-0021	東京都渋谷区恵比寿西1-33-15 EN代官山 1F	TEL.03-5458-4050	FAX.03-5458-4068
■DULTON DAY STACK KASHIWANOHA	〒277-0812	千葉県柏市花野井702-1	TEL.04-7193-8121	FAX.04-7193-8122
■DULTON MARKET STORE CHIBA NEW TOWN	〒270-1369	千葉県印西市鹿黒南5-2 グッドマンビジネスパーク theGreen 1F	TEL.0476-85-7948	FAX.0476-85-7949
■D.F.SERVICE OMIYA	〒337-0043	埼玉県さいたま市見沼区大字中川1068-1	TEL.048-872-6314	FAX.048-872-6325
■DULTON TEMMABASHI	〒540-0037	大阪府大阪市中央区内平野町1-2-4 1/2F	TEL.06-6910-6648	
■D.F.SERVICE OSAKA	〒533-0004	大阪府大阪市東淀川区小松3-21-57	TEL.06-4862-7190	FAX.06-4862-7191
■DULTON DAY STACK MUKONOSO	〒661-0026	兵庫県尼崎市水堂町3-15-26	TEL.06-6423-8750	FAX.06-6423-8751
■DULTON DAY STACK NAGOYA	〒451-0051	愛知県名古屋市区別武新町3-1-17 イオンモール Nagoya Noritake Garden 1F	TEL.052-433-2840	FAX.052-433-2841

www.dulton.jp

4 997337 093248



2024-2
¥1,389+税