

2024

New Items Information

WONDER ZONE 21 Additional Edition



PP BAG SERIES



382-007G



NEW 382-006R
 28 × 18.5 × H39 × TH59
 ¥380 (200入)
 ロット5 ダ鉢5号用
 4951169111303



NEW 382-006P
 28 × 18.5 × H39 × TH59
 ¥380 (200入)
 ロット5 ダ鉢5号用
 4951169111297



NEW 382-007G
 28 × 18.5 × H39 × TH59
 ¥380 (200入)
 ロット5 ダ鉢5号用
 4951169111327



NEW 382-007P
 28 × 18.5 × H39 × TH59
 ¥380 (200入)
 ロット5 ダ鉢5号用
 4951169111310



382-005R
28 × 18.5 × H39 × TH59
¥ 380 (200入)
ロット5 ダ鉢5号用
4951169107115



382-005P
28 × 18.5 × H39 × TH59
¥ 380 (200入)
ロット5 ダ鉢5号用
4951169107122



382-004R
22 × 15.5 × H30 × TH48.5
¥ 300 (200入)
ロット5 ダ鉢4号用
4951169107078



382-004P
22 × 15.5 × H30 × TH48.5
¥ 300 (200入)
ロット5 ダ鉢4号用
4951169107092



L-50D
φ 17 × H15.5
¥ 140 (500入)
ロット10 ダ鉢5号用
4951169107160



L-40D
φ 14 × H12
¥ 90 (1000入)
ロット10 ダ鉢4号用
4951169107153



PPバッグは防水ではありません。
ライナー等を入れてご使用ください。



コンパクトに折畳めます。

PAPER BAG SERIES



NEW 381-028R
 17 × 17 × H20 × TH41
 ¥ 340 (200入)
 ロット10 ダ鉢5号用
 4951169111228



NEW 381-029R
 13 × 13 × H15.5 × TH37
 ¥ 290 (250入)
 ロット10 ダ鉢4号用
 4951169111242



NEW 381-030R
 12 × 12 × H12.5 × TH34
 ¥ 270 (250入)
 ロット10 ダ鉢3号用
 4951169111266



NEW 381-031R
 22 × 10.5 × H12.5 × TH34
 ¥ 340 (250入)
 ロット10 連鉢3号用
 4951169111280



NEW 381-028P
 17 × 17 × H20 × TH41
 ¥ 340 (200入)
 ロット10 ダ鉢5号用
 4951169111211



NEW 381-029P
 13 × 13 × H15.5 × TH37
 ¥ 290 (250入)
 ロット10 ダ鉢4号用
 4951169111235



NEW 381-030P
 12 × 12 × H12.5 × TH34
 ¥ 270 (250入)
 ロット10 ダ鉢3号用
 4951169111259



NEW 381-031P
 22 × 10.5 × H12.5 × TH34
 ¥ 340 (250入)
 ロット10 連鉢3号用
 4951169111273



内側に撥水加工を施しています。
 ※完全防水ではありません。



コンパクトに折畳めます。



381-029P / 381-030R



381-007R
 17×17×H20×TH41
 ¥320 (200入)
 ロット10 ダ鉢5号用
 4951169103919



381-008R
 13×13×H15.5×TH37
 ¥270 (250入)
 ロット10 ダ鉢4号用
 4951169103926



381-007P
 17×17×H20×TH41
 ¥320 (200入)
 ロット10 ダ鉢5号用
 4951169103896

PAPER BAG SERIES



NEW 381-027P
22 × 10.5 × H12.5 × TH34
¥340 (250入)
ロット10 連鉢3号用
4951169111204



NEW 381-027G
22 × 10.5 × H12.5 × TH34
¥340 (250入)
ロット10 連鉢3号用
4951169111198



NEW 381-023P
17 × 17 × H20 × TH41
¥340 (200入)
ロット10 鉢5号用
4951169111129



NEW 381-024P
13 × 13 × H15.5 × TH37
¥290 (250入)
ロット10 鉢4号用
4951169111143



NEW 381-025P
12 × 12 × H12.5 × TH34
¥270 (250入)
ロット10 鉢3号用
4951169111167



NEW 381-026P
9 × 9 × H10 × TH29
¥200 (250入)
ロット10 鉢2.5号用
4951169111181



NEW 381-023G
17 × 17 × H20 × TH41
¥340 (200入)
ロット10 鉢5号用
4951169111112



NEW 381-024G
13 × 13 × H15.5 × TH37
¥290 (250入)
ロット10 鉢4号用
4951169111136



NEW 381-025G
12 × 12 × H12.5 × TH34
¥270 (250入)
ロット10 鉢3号用
4951169111150



NEW 381-026G
9 × 9 × H10 × TH29
¥200 (250入)
ロット10 鉢2.5号用
4951169111174

PAPER BAG SERIES



381-015 (無地)
22×10.5×H12.5×TH34
¥270 (250入)
ロット10 連鉢3号用
4951169107009



381-016 (英字柄)
22×10.5×H12.5×TH34
¥300 (250入)
ロット10 連鉢3号用
4951169107016



内側に撥水加工を施しています。
※完全防水ではありません。



コンパクトに折畳めます。



381-001 (無地)
17×17×H20×TH41
¥260 (200入)
ロット10 鉢5号用
4951169101038



381-002 (無地)
13×13×H15.5×TH37
¥230 (250入)
ロット10 鉢4号用
4951169101045



381-003 (無地)
12×12×H12.5×TH34
¥210 (250入)
ロット10 鉢3号用
4951169101052



381-013 (無地)
9×9×H10×TH29
¥180 (250入)
ロット10 鉢2.5号用
4951169106989



381-004 (英字柄)
17×17×H20×TH41
¥290 (200入)
ロット10 鉢5号用
4951169101069



381-005 (英字柄)
13×13×H15.5×TH37
¥260 (250入)
ロット10 鉢4号用
4951169101076



381-006 (英字柄)
12×12×H12.5×TH34
¥240 (250入)
ロット10 鉢3号用
4951169101083



381-014 (英字柄)
9×9×H10×TH29
¥200 (250入)
ロット10 鉢2.5号用
4951169106996

MILLE MERCIS SERIES



759-40H



NEW 759-50H ▽ V付
 φ18×H17×TH51 CH
 (内寸φ17×H16)
 ¥1,080 (48入)
 ロット1 ダ鉢5号用
 4951169110641



NEW 759-40H ▽ V付
 φ15×H12.5×TH42
 (内寸φ14×H11.5)
 ¥780 (90入)
 ロット1 ダ鉢4号用
 4951169110634



NEW 759-50D ▽ V付
 φ18×H17
 (内寸φ17×H16)
 ¥780 (80入)
 ロット1 ダ鉢5号用
 4951169110603



NEW 759-40D ▽ V付
 φ15×H12.5
 (内寸φ14×H11.5)
 ¥580 (144入)
 ロット1 ダ鉢4号用
 4951169110597



NEW
 759-50W ▽ V付
 35.5×18×H16.5
 (内寸 34×17×H15.5)
 ¥1,280 (45入)
 ロット1 連鉢5号用
 4951169110627



NEW
 759-40W ▽ V付
 29.5×15×H12.5
 (内寸 28×14×H11.5)
 ¥950 (54入)
 ロット1 連鉢4号用
 4951169110610



NEW 760-50D ▽ V付
 φ18×H17
 (内寸φ17×H16)
 ¥780 (80入)
 ロット1 ダ鉢5号用
 4951169110658



NEW 761-50D ▽ V付
 φ18×H17
 (内寸φ17×H16)
 ¥780 (80入)
 ロット1 ダ鉢5号用
 4951169110665



756-50H ▽ V付
 φ18×H17×TH51 CH
 (内寸φ17×H16)
 ¥980 (48入)
 ロット1 ダ鉢5号用
 4951169103742



755-50H ▽ V付
 φ18×H17×TH51 CH
 (内寸φ17×H16)
 ¥980 (48入)
 ロット1 ダ鉢5号用
 4951169103728



758-204 ▽ V付
 φ20.5×H10
 (内寸φ19.5×H9)
 ¥720 (80入) ロット1
 2/3本・寄せ鉢3号兼用
 4951169106651



758-205 ▽ V付
 φ23.5×H11
 (内寸φ22.5×H10)
 ¥840 (60入) ロット1
 3/4本・寄せ鉢3.5号兼用
 4951169106668



758-206 ▽ V付
 φ28×H13
 (内寸φ27×H12)
 ¥1,050 (40入) ロット1
 1本・寄せ鉢4号兼用
 4951169106675



758-30W ▽ V付
 23×12×H10
 (内寸21.5×11×H9)
 ¥680 (80入)
 ロット1 連鉢3号用
 4951169106682



758-40W ▽ V付
 29.5×15×H12.5
 (内寸28×14×H11.5)
 ¥920 (54入)
 ロット1 連鉢4号用
 4951169106699



758-50W ▽ V付
 35.5×18×H16.5
 (内寸34×17×H15.5)
 ¥1,250 (45入)
 ロット1 連鉢5号用
 4951169106712

MELAMINE POT SERIES

エール
Aile



153-005W / 153-004W / 153-006W

White



153-006W
φ9.5×H8.5
¥260 (180入)
ロット10
1/8本・ダ鉢2.5号兼用
4951169106514

Pink



153-006P
φ9.5×H8.5
¥260 (180入)
ロット10
1/8本・ダ鉢2.5号兼用
4951169106491

Beige



153-006B
φ9.5×H8.5
¥260 (180入)
ロット10
1/8本・ダ鉢2.5号兼用
4951169106477

Greige



153-006G
φ9.5×H8.5
¥260 (180入)
ロット10
1/8本・ダ鉢2.5号兼用
4951169106484

Black



NEW 153-006K
φ9.5×H8.5
¥260 (180入)
ロット10
1/8本・ダ鉢2.5号兼用
4951169108815



153-005W
φ11.5×H10.5
¥380 (120入)
ロット10
1/3本・ダ鉢3号兼用
4951169106460



153-005P
φ11.5×H10.5
¥380 (120入)
ロット10
1/3本・ダ鉢3号兼用
4951169106453



153-005B
φ11.5×H10.5
¥380 (120入)
ロット10
1/3本・ダ鉢3号兼用
4951169106439



153-005G
φ11.5×H10.5
¥380 (120入)
ロット10
1/3本・ダ鉢3号兼用
4951169106446



NEW 153-005K
φ11.5×H10.5
¥380 (120入)
ロット10
1/3本・ダ鉢3号兼用
4951169108808



153-004W
φ13.5×H11.5
¥490 (80入)
ロット5
1/2本・ダ鉢3.5号兼用
4951169106422



153-004P
φ13.5×H11.5
¥490 (80入)
ロット5
1/2本・ダ鉢3.5号兼用
4951169106415



153-004B
φ13.5×H11.5
¥490 (80入)
ロット5
1/2本・ダ鉢3.5号兼用
4951169106392



153-004G
φ13.5×H11.5
¥490 (80入)
ロット5
1/2本・ダ鉢3.5号兼用
4951169106408



NEW 153-004K
φ13.5×H11.5
¥490 (80入)
ロット5
1/2本・ダ鉢3.5号兼用
4951169108792

MELAMINE POT SERIES

White



153-009W
8×8×H7.5
¥210 (180入)
ロット10
1/8本・ダ鉢2.5号兼用
4951169106644

Pink



153-009P
8×8×H7.5
¥210 (180入)
ロット10
1/8本・ダ鉢2.5号兼用
4951169106637

Beige



153-009B
8×8×H7.5
¥210 (180入)
ロット10
1/8本・ダ鉢2.5号兼用
4951169106613

Greige



153-009G
8×8×H7.5
¥210 (180入)
ロット10
1/8本・ダ鉢2.5号兼用
4951169106620

Black



NEW 153-009K
8×8×H7.5
¥210 (180入)
ロット10
1/8本・ダ鉢2.5号兼用
4951169108846



153-008W
10×10×H9.5
¥360 (120入)
ロット10
1/3本・ダ鉢3号兼用
4951169106590



153-008P
10×10×H9.5
¥360 (120入)
ロット10
1/3本・ダ鉢3号兼用
4951169106583



153-008B
10×10×H9.5
¥360 (120入)
ロット10
1/3本・ダ鉢3号兼用
4951169106569



153-008G
10×10×H9.5
¥360 (120入)
ロット10
1/3本・ダ鉢3号兼用
4951169106576



NEW 153-008K
10×10×H9.5
¥360 (120入)
ロット10
1/3本・ダ鉢3号兼用
4951169108839



153-007W
12.5×12.5×H12
¥550 (80入)
ロット5
1/2本・ダ鉢3.5号兼用
4951169106552



153-007P
12.5×12.5×H12
¥550 (80入)
ロット5
1/2本・ダ鉢3.5号兼用
4951169106545



153-007B
12.5×12.5×H12
¥550 (80入)
ロット5
1/2本・ダ鉢3.5号兼用
4951169106521



153-007G
12.5×12.5×H12
¥550 (80入)
ロット5
1/2本・ダ鉢3.5号兼用
4951169106538



NEW 153-007K
12.5×12.5×H12
¥550 (80入)
ロット5
1/2本・ダ鉢3.5号兼用
4951169108822



シエル
Ciel

153-007G / 153-008G / 153-009G

MELAMINE POT SERIES

ビジュー
Bijoux

White



153-003W
 ϕ 9.5×H5.5
 ¥190 (240入)
 ロット10 1/16本用
 4951169106385

Pink



153-003P
 ϕ 9.5×H5.5
 ¥190 (240入)
 ロット10 1/16本用
 4951169106378

Beige



153-003B
 ϕ 9.5×H5.5
 ¥190 (240入)
 ロット10 1/16本用
 4951169106354

Greige



153-003G
 ϕ 9.5×H5.5
 ¥190 (240入)
 ロット10 1/16本用
 4951169106361



153-002W
 ϕ 11.5×H6.5
 ¥260 (180入)
 ロット10 1/8本用
 4951169106347



153-002P
 ϕ 11.5×H6.5
 ¥260 (180入)
 ロット10 1/8本用
 4951169106330



153-002B
 ϕ 11.5×H6.5
 ¥260 (180入)
 ロット10 1/8本用
 4951169106316



153-002G
 ϕ 11.5×H6.5
 ¥260 (180入)
 ロット10 1/8本用
 4951169106323



153-001W
 ϕ 14.5×H8
 ¥400 (120入)
 ロット10 1/3本用
 4951169106309



153-001P
 ϕ 14.5×H8
 ¥400 (120入)
 ロット10 1/3本用
 4951169106293



153-001B
 ϕ 14.5×H8
 ¥400 (120入)
 ロット10 1/3本用
 4951169106279



153-001G
 ϕ 14.5×H8
 ¥400 (120入)
 ロット10 1/3本用
 4951169106286

ミニヨン
Mignon

White



153-010W
 ϕ 11.5×H7.5
 (内寸 ϕ 10×H7)
 ¥480 (80入)
 ロット5 マット仕上げ
 4951169107283



153-011W
 ϕ 9.5×H6.5
 (内寸 ϕ 8.5×H6)
 ¥380 (120入)
 ロット5 マット仕上げ
 4951169107306

Gray



153-010G
 ϕ 11.5×H7.5
 (内寸 ϕ 10×H7)
 ¥480 (80入)
 ロット5 マット仕上げ
 4951169107276



153-011G
 ϕ 9.5×H6.5
 (内寸 ϕ 8.5×H6)
 ¥380 (120入)
 ロット5 マット仕上げ
 4951169107290



エクラ
Éclat

Clear



NEW 154-012C
φ 10.5×H9.5
¥ 580 (100入)
ロット5
1/3本・3.5号ポット兼用
4951169109119

Amber



NEW 154-012A
φ 10.5×H9.5
¥ 580 (100入)
ロット5
1/3本・3.5号ポット兼用
4951169109096

Antique Blue



NEW 154-012BL
φ 10.5×H9.5
¥ 580 (100入)
ロット5
1/3本・3.5号ポット兼用
4951169109102

Smoke Black

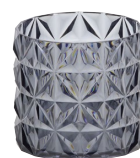

NEW 154-012K
φ 10.5×H9.5
¥ 580 (100入)
ロット5
1/3本・3.5号ポット兼用
4951169109126

Retro Green



NEW 154-009C
φ 8.5×H10.5
¥ 580 (100入)
ロット5
4951169108860



NEW 154-009A
φ 8.5×H10.5
¥ 580 (100入)
ロット5
4951169108853



NEW 154-009G
φ 8.5×H10.5
¥ 580 (100入)
ロット5
4951169108877



NEW 154-009K
φ 8.5×H10.5
¥ 580 (100入)
ロット5
4951169108884

ACRYLIC POT SERIES

クレール
clair

1/8本・2.5号ポット兼用サイズ

Clear



NEW
154-004
φ8×H8
¥380 (100入)
ロット5 透明
4951169108662

White



154-002W
φ8×H8
¥450 (100入)
ロット5
4951169107368

Light Gray



154-002G
φ8×H8
¥450 (100入)
ロット5
4951169107351

Pink



NEW
154-002P
φ8×H8
¥450 (100入)
ロット5
4951169108525

Brown



154-002B
φ8×H8
¥450 (100入)
ロット5
4951169107344

Black



NEW
154-002K
φ8×H8
¥450 (100入)
ロット5
4951169108532

1/4本・3号ポット兼用サイズ



NEW
154-003
φ9.5×H9.5
¥480 (80入)
ロット5 透明
4951169108655



154-001W
φ9.5×H9.5
¥580 (80入)
ロット5
4951169107337



154-001G
φ9.5×H9.5
¥580 (80入)
ロット5
4951169107320



NEW
154-001P
φ9.5×H9.5
¥580 (80入)
ロット5
4951169108501



154-001B
φ9.5×H9.5
¥580 (80入)
ロット5
4951169107313



NEW
154-001K
φ9.5×H9.5
¥580 (80入)
ロット5
4951169108518

1/3本・3.5号ポット兼用サイズ



NEW
154-010
φ11×H11
¥650 (80入)
ロット5 透明
4951169109997



NEW
154-011W
φ11×H11
¥800 (80入)
ロット5
4951169110047



NEW
154-011G
φ11×H11
¥800 (80入)
ロット5
4951169110030



NEW
154-011P
φ11×H11
¥800 (80入)
ロット5
4951169110016



NEW
154-011B
φ11×H11
¥800 (80入)
ロット5
4951169110023



NEW
154-011K
φ11×H11
¥800 (80入)
ロット5
4951169110009



154-006G / 154-002P

1/6本用・2.5号ポット兼用サイズ

Clear



NEW
154-008
8×8×H8
¥450 (100入)
ロット5 透明
4951169108785

White



NEW
154-006W
8×8×H8
¥550 (100入)
ロット5
4951169108723

Light Gray



NEW
154-006G
8×8×H8
¥550 (100入)
ロット5
4951169108730

Pink



NEW
154-006P
8×8×H8
¥550 (100入)
ロット5
4951169108754

Brown



NEW
154-006B
8×8×H8
¥550 (100入)
ロット5
4951169108761

Black



NEW
154-006K
8×8×H8
¥550 (100入)
ロット5
4951169108747

1/3本用・3号ポット兼用サイズ



NEW
154-007
9×9×H9
¥550 (80入)
ロット5 透明
4951169108778



NEW
154-005W
9×9×H9
¥650 (80入)
ロット5
4951169108679



NEW
154-005G
9×9×H9
¥650 (80入)
ロット5
4951169108686



NEW
154-005P
9×9×H9
¥650 (80入)
ロット5
4951169108709



NEW
154-005B
9×9×H9
¥650 (80入)
ロット5
4951169108716



NEW
154-005K
9×9×H9
¥650 (80入)
ロット5
4951169108693

STONE PLASTIC MATERIAL SERIES



White



NEW

150-038W S
 9.5×9.5×H9
 ¥860 (54入)
 ロット1
 1/3本・3号ポット兼用
 4951169109034

Gray



NEW

150-038G S
 9.5×9.5×H9
 ¥860 (54入)
 ロット1
 1/3本・3号ポット兼用
 4951169109003

Beige



NEW

150-038BE S
 9.5×9.5×H9
 ¥860 (54入)
 ロット1
 1/3本・3号ポット兼用
 4951169109065

Lime Green



NEW

150-038LG S
 9.5×9.5×H9
 ¥860 (54入)
 ロット1
 1/3本・3号ポット兼用
 4951169109010

Pink



NEW

150-038P S
 9.5×9.5×H9
 ¥860 (54入)
 ロット1
 1/3本・3号ポット兼用
 4951169109027

Black



NEW 150-039W S
 25.5×12×H10
 ¥1,380 (20入)
 ロット1
 1本・3.5号連鉢兼用
 4951169109058



NEW 150-039K S
 25.5×12×H10
 ¥1,380 (20入)
 ロット1
 1本・3.5号連鉢兼用
 4951169109041

STONE PLASTIC MATERIAL SERIES

150シリーズはリサイクル素材を配合したサステナブルな商品として、「サステナブルマーク **S**」を付けています。

White Stone



150-030W **S**
φ10×H10
¥400 (96入)
ロット6 1/6本用
4951169103582



150-010W **S**
φ12×H12
¥520 (48入)
ロット1 1/3本用
4951169020162



150-019W **S**
13×9×H8.5
¥390 (96入)
ロット6 1/8本用
4951169047978



150-024W **S**
15×11×H10
¥520 (72入)
ロット1
1/3本用 リブ付
4951169085437



150-006W **S**
20×15×H12
¥780 (36入)
ロット1 1/2本用
4951169019975



150-005W **S**
25×18×H15
¥1,150 (24入)
ロット1 3/4本用
4951169019852

Color Variations



White



Gray



Black



Taupe



Beige



Gold



Lime Green



Blue



Pink



Purple



Red



150シリーズ
人気ラインナップ
詳しくはこちら



FRP POT SERIES



160-005W

FRP(Fiber Reinforced Plastics : 繊維強化プラスチック)とは、樹脂を繊維で補強することによって、強度を向上させたプラスチックです。軽くて丈夫で、耐腐食性・耐候性に優れています。

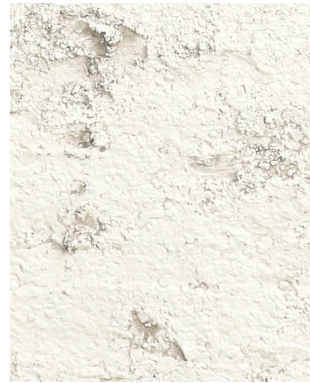
ガレット
Galet

White Stone



NEW 160-005W
35×35×H35
¥15,800 (2入)
ロット1 小箱入
ケンガイ10号用
4951169110559

重量: 3.8kg



NEW 160-006W
28×28×H28
¥10,000 (4入)
ロット1 小箱入
ケンガイ8号用
4951169110573

重量: 2.5kg

Ash Stone



NEW 160-005G
35×35×H35
¥15,800 (2入)
ロット1 小箱入
ケンガイ10号用
4951169110566

重量: 3.8kg



NEW 160-006G
28×28×H28
¥10,000 (4入)
ロット1 小箱入
ケンガイ8号用
4951169110580

重量: 2.5kg

FRP POT SERIES

クラス
Classe

Brushed Silver



NEW 160-004S
φ43×H40
¥9,800 (5入)
ロット1
ケンガイ12号用
4951169110542

重量:2.3kg



NEW 160-001S
φ35×H35
¥13,800 (2入)
ロット1 小箱入
ケンガイ10号用
4951169110481

重量:2.7kg



NEW 160-002S
φ28×H28
¥8,200 (4入)
ロット1 小箱入
ケンガイ8号用
4951169110504

重量:1.5kg



NEW 160-003S
φ21×H21
¥5,000 (8入)
ロット1 小箱入
4951169110528

重量:0.8kg

Brushed Black



NEW 160-004K
φ43×H40
¥9,800 (5入)
ロット1
ケンガイ12号用
4951169110535

重量:2.3kg



NEW 160-001K
φ35×H35
¥13,800 (2入)
ロット1 小箱入
ケンガイ10号用
4951169110474

重量:2.7kg



NEW 160-002K
φ28×H28
¥8,200 (4入)
ロット1 小箱入
ケンガイ8号用
4951169110498

重量:1.5kg



NEW 160-003K
φ21×H21
¥5,000 (8入)
ロット1 小箱入
4951169110511

重量:0.8kg



内底はフラット。



ドリルで穴をあけられます。
(裏底にガイドがあります。)

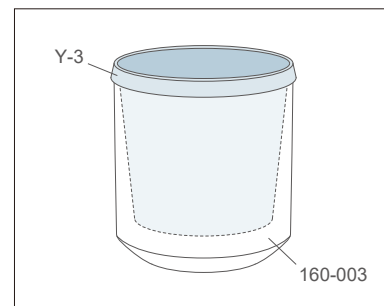

160-003はY-3がフチにかかります。

PAPER WOOD SERIES

※木目調にプリントした紙を貼り付けた商品です。



NEW 771-50D ▽
φ18.5×H16
¥790 (72入)
ロット1 ダ鉢5号用
4951169110733



771-203



NEW 771-205 ▽
φ24.5×H10
¥900 (60入) ロット1
3/4本・寄せ鉢3.5号兼用
4951169110719



NEW 771-204 ▽
φ21.5×H9.5
¥760 (72入) ロット1
2/3本・寄せ鉢3号兼用
4951169110702



NEW 771-203 ▽
φ18×H8.5
¥650 (96入) ロット6
1/2本・寄せ鉢2.5号兼用
4951169110696



NEW 771-202 ▽
φ15.5×H8
¥540 (144入)
ロット6 1/3本用
4951169110689



NEW 771-201 ▽
φ13×H7
¥460 (180入)
ロット10 1/6本用
4951169110672



NEW 771-50W ▽
35×21×H16
¥1,350 (42入)
ロット1 連鉢5号用
4951169110740



NEW 771-40W ▽
26.5×17.5×H13
¥1,050 (54入)
ロット1 連鉢4号用
4951169110726

Vintage Wash Willow Basket



NEW 621-001 ▽ V付
33×24×H14
¥1,680 (36入) ロット1
4951169109133



NEW 621-002 ▽ V付
28×20×H13
¥1,380 (48入) ロット1
4951169109140



NEW 621-003 ▽ V付
23×17×H11
¥980 (80入) ロット1
4951169109157

VARIOUS TASTE VINE WIRE BASKET

600シリーズは天然素材のみを使用したサステナブルな商品として、「サステナブルマーク **S**」を付けています。

White Wash



NEW 638-003W ▽ V付
19×13×H11×TH22
¥1,080 (60入) ロット1
4951169109188



NEW 638-002W ▽ V付
23×15×H12×TH23
¥1,400 (48入) ロット1
4951169109171



NEW 638-001W ▽ V付
31×16×H12×TH24
¥2,300 (32入) ロット1
4951169109164

Natural



NEW 638-006B V付
19×13×H11×TH22
¥1,080 (60入) ロット1
4951169109218



NEW 638-005B V付
23×15×H12×TH23
¥1,400 (48入) ロット1
4951169109201



NEW 638-004B V付
31×18×H12×TH24
¥2,300 (32入) ロット1
4951169109195



NEW **S**
600-516 (丸型)
φ52×H15.5×TH23.5
(内寸: φ48×H13.5)
¥4,200 (15入)
ロット1
4951169111068

Black Willow Basket



NEW **S**
600-515 (小判型)
38×28×H14×TH20
(内寸: 35×27×H13)
¥2,800 (36入)
ロット1
4951169111051



NEW **S**
600-514 (小判型)
48×35×H16×TH22.5
(内寸: 46×33×H15)
¥3,500 (24入)
ロット1
4951169111044

GARDEN BURIKI SERIES



548-40DW / 548-50DB / 548-50DW



NEW 548-50DW L付
 φ18×H18
 (内寸: φ17.5×H17.5)
 ¥1,200 (48入) ロット1
 鉢5号用 底穴あき
 4951169111808



NEW 548-40DW L付
 φ14×H14.5
 (内寸: φ13.5×H14)
 ¥980 (72入) ロット1
 鉢4号用 底穴あき
 4951169111822



NEW 548-50DB L付
 φ18×H18
 (内寸: φ17.5×H17.5)
 ¥1,200 (48入) ロット1
 鉢5号用 底穴あき
 4951169111792



NEW 548-40DB L付
 φ14×H14.5
 (内寸: φ13.5×H14)
 ¥980 (72入) ロット1
 鉢4号用 底穴あき
 4951169111815



NEW 548-004W L付
14×24×H13×TH28.5
(内寸: φ13×H12.5)
¥680 (64入)
ロット1 鉢鉢4号用
底穴あき
4951169111761



NEW 548-005W L付
11×20×H11×TH25
(内寸: φ10×H10.5)
¥540 (80入) ロット1
1/3本・鉢鉢3号兼用
底穴あき
4951169111785



NEW 548-004B L付
14×24×H13×TH28.5
(内寸: φ13×H12.5)
¥680 (64入)
ロット1 鉢鉢4号用
底穴あき
4951169111754



NEW 548-005B L付
11×20×H11×TH25
(内寸: φ10×H10.5)
¥540 (80入) ロット1
1/3本・鉢鉢3号兼用
底穴あき
4951169111778



NEW 548-30WW L付
20×11.5×H10×TH21
(内寸: 19×11×H9.5)
¥760 (48入) ロット1
連鉢3号用 底穴あき
4951169111853



NEW 548-30WG L付
20×11.5×H10×TH21
(内寸: 19×11×H9.5)
¥760 (48入) ロット1
連鉢3号用 底穴あき
4951169111846



NEW 548-003W L付
13×10×H12.5×TH13.5
(内寸: φ9.5×H12.5)
¥520 (72入)
ロット1 底穴あき
4951169111747



NEW 548-006W L付
28×11.5×H10.5
(内寸: 27.5×11×H8)
¥1,000 (36入)
ロット1 底穴あき
4951169111839



548-006W

GARDEN BURIKI & GARDEN WOOD SERIES



548-002G/739-041W



NEW

548-001W
 φ12×H6×TH35.5
 ¥1,280 (60入)
 ロット1
 4951169110788

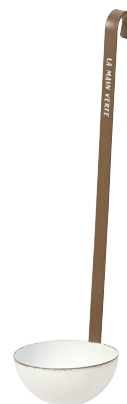

NEW

548-002W
 φ8×H4×TH29.5
 ¥680 (100入)
 ロット1
 4951169110818



NEW

548-002B
 φ8×H4×TH29.5
 ¥680 (100入)
 ロット1
 4951169110795

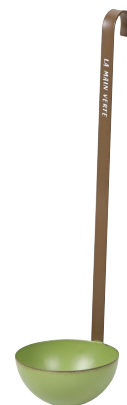

NEW

548-002G
 φ8×H4×TH29.5
 ¥680 (100入)
 ロット1
 4951169110801

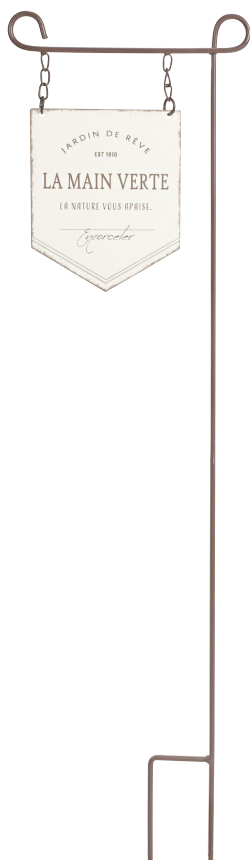

NEW

514-036
 21×75
 (パネル: 13×15.5)
 ¥1,700 (40入)
 ロット1
 4951169110757

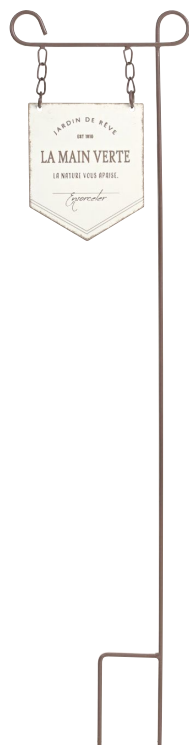

NEW

514-037
 15.5×65.5
 (パネル: 10×12)
 ¥1,500 (60入)
 ロット1
 4951169110764



NEW

514-038
 15.5×45.5
 (パネル: 8×8.5)
 ¥1,400 (80入)
 ロット1
 4951169110771



NEW

739-046W ▽
 23.5×49 (厚み: 1)
 ¥1,400 (20入)
 ロット1
 4951169110887

GARDEN WOOD SERIES



NEW

739-044W ▽
28×15×H10.5
¥2,200 (20入)
ロット1
4951169110856



NEW

739-043W ▽
32×19×H11
¥2,800 (18入)
ロット1
4951169110849



NEW

739-045W ▽
28×17×H14×TH40.5
¥3,800 (8入) ロット1
壁掛け用リング付
4951169110870



NEW

739-045B ▽
28×17×H14×TH40.5
¥3,800 (8入) ロット1
壁掛け用リング付
4951169110863



NEW

739-042W ▽
27.5×39×H77
¥4,600 (15入)
ロット1 折畳み可
4951169110832



NEW

739-041W ▽
27.5×46×H94.5
¥5,200 (10入)
ロット1 折畳み可
4951169110825

IRON FOLDING STAND SERIES

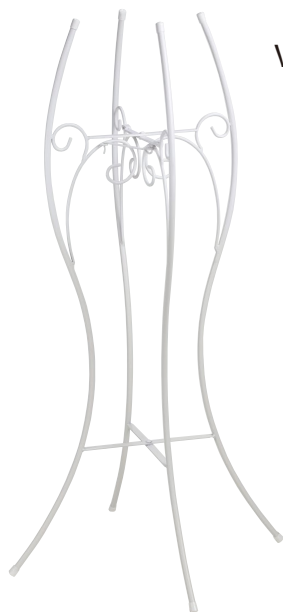

White

NEW

514-032W
48×48×H90
¥9,500 (6入)
ロット1 小箱入
折畳み可
Y-3対応スタンド
4951169109232

重量:1.3kg

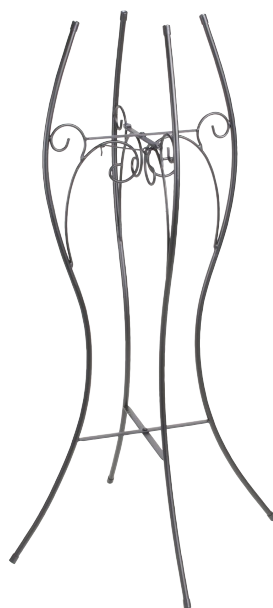

Vintage

NEW

514-032V
48×48×H90
¥9,500 (6入)
ロット1 小箱入
折畳み可
Y-3対応スタンド
4951169109225

重量:1.3kg



514-032W

514-031V



514-031W
48×48×H120
¥10,800 (6入)
ロット1 小箱入
折畳み可
Y-3対応スタンド
4951169106781

重量:1.6kg



514-031V
48×48×H120
¥10,800 (6入)
ロット1 小箱入
折畳み可
Y-3対応スタンド
4951169106774

重量:1.6kg

Y-3オトシ装着イメージ
※オトシは付属していません

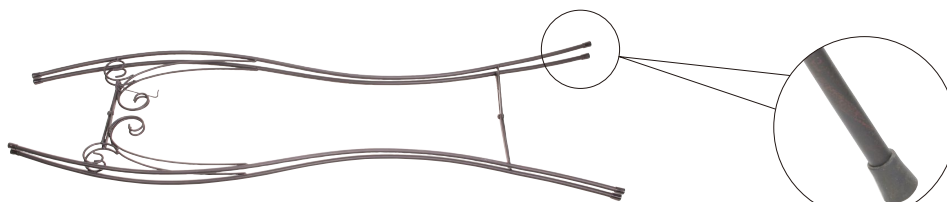

スタンドは折畳めます。持ち運び、収納時に便利です。
不意に閉じないように開閉を固定するフック型ストッパー付き。

支柱の上下先端はゴムキャップを装着。
床面の傷つき防止と床、容器の滑り止め
効果で安定性があります。

CANDLE STAND



NEW
514-035W
φ11×H23.5
(受け皿φ10)
¥2,200 (48入)
ロット1
4951169109980



NEW
514-034W
φ11×H28
(受け皿φ10)
¥2,400 (32入)
ロット1
4951169109959



NEW
514-033W
φ11×H35
(受け皿φ10)
¥2,600 (24入)
ロット1
4951169109928



514-035W / 514-034W



NEW
514-035S
φ11×H23.5
(受け皿φ10)
¥2,200 (48入)
ロット1
4951169109966



NEW
514-034S
φ11×H28
(受け皿φ10)
¥2,400 (32入)
ロット1
4951169109935



NEW
514-033S
φ11×H35
(受け皿φ10)
¥2,600 (24入)
ロット1
4951169109249



NEW
514-035B
φ11×H23.5
(受け皿φ10)
¥2,200 (48入)
ロット1
4951169109973



NEW
514-034B
φ11×H28
(受け皿φ10)
¥2,400 (32入)
ロット1
4951169109942



NEW
514-033B
φ11×H35
(受け皿φ10)
¥2,600 (24入)
ロット1
4951169109256

WOOD FRAME VASE & WREATH



739-040B

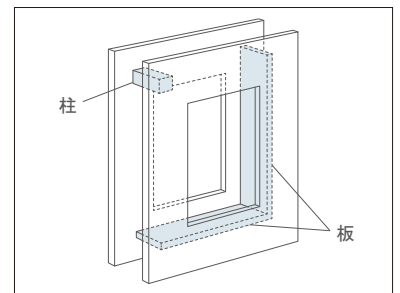

内側には、フォームが置ける板と、花を引っ掛けられる柱がついています。



縦横どちらでも使えます。



739-039W ▽
24×7×H30
¥1,980 (20入)
ロット1
4951169105418



739-040W ▽
20×6×H24
¥1,480 (30入)
ロット1
4951169105425

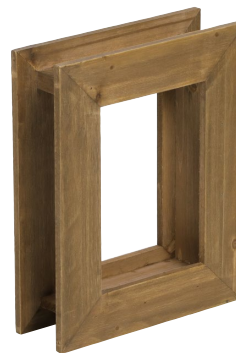

NEW 739-039B ▽
24×7×H30
¥1,980 (20入)
ロット1
4951169109072



NEW 739-040B ▽
20×6×H24
¥1,480 (30入)
ロット1
4951169109089



NEW 607-128
φ25×2.5
¥750 (120入)
ロット1
4951169110894



NEW 607-129
φ20×2.5
¥580 (160入)
ロット5
4951169110900



NEW 607-130
φ15×2
¥390 (240入)
ロット5
4951169110917

WREATH BAG & WREATH STAND



381-021
30×10×H30×TH42
¥360 (200入) ロット5
φ23~25サイズリースボックス対応
4951169107139



381-022
24×9×H24×TH37
¥290 (200入) ロット5
φ18サイズリースボックス対応
4951169107146



箔押しのタグ付き。



コンパクトに折畳めます。



739-035W ▽
31×29×H40.5
¥3,400 (18入)
ロット1 折畳み可
4951169103407



739-036W ▽
25×20×H34
¥2,300 (24入)
ロット1 折畳み可
4951169103421



739-037W ▽
26×22×H35
¥1,280 (60入)
ロット1 折畳み可
4951169103438



739-035B ▽
31×29×H40.5
¥3,400 (18入)
ロット1 折畳み可
4951169103391



739-036B ▽
25×20×H34
¥2,300 (24入)
ロット1 折畳み可
4951169103414



背面にフックが付いています。



NEW 660-059 ▽
φ24
¥2,200 (24入)
ロット1
麻紐付・小箱入
4951169111907



NEW 660-059S ▽
φ18
¥1,380 (48入)
ロット1
麻紐付・小箱入
4951169111914



NEW 660-060 ▽
φ23
¥2,200 (24入)
ロット1
麻紐付・小箱入
4951169111921



NEW 660-060S ▽
φ17
¥1,380 (48入)
ロット1
麻紐付・小箱入
4951169111938



NEW 660-061 ▽
φ24
¥2,200 (24入)
ロット1
麻紐付・小箱入
4951169111945



NEW 660-061S ▽
φ18
¥1,380 (48入)
ロット1
麻紐付・小箱入
4951169111952



660-047 ▽
φ24
¥2,500 (24入)
ロット1
麻紐付・小箱入
4951169107184



660-047S ▽
φ18
¥1,480 (48入)
ロット1
麻紐付・小箱入
4951169107191



660-032 ▽
φ24
¥2,200 (24入)
ロット1
麻紐付・小箱入
4951169103858



660-032S ▽
φ18
¥1,380 (48入)
ロット1
麻紐付・小箱入
4951169103865



660-019 ▽
φ24
¥2,200 (24入)
ロット1
麻紐付・小箱入
4951169100314



660-019S ▽
φ18
¥1,380 (48入)
ロット1
麻紐付・小箱入
4951169100321

※このページの商品は他の商品と掛率が異なります。

ALL SEASON WREATH



660-058L ▽
φ30
¥2,700 (16入)
ロット1
麻紐付・小箱入
4951169108358



660-058 ▽
φ25
¥2,200 (24入)
ロット1
麻紐付・小箱入
4951169108341



660-058S ▽
φ18
¥1,380 (48入)
ロット1
麻紐付・小箱入
4951169108365



リースはすべてボックス付きです。



660-033 ▽
φ24
¥2,200 (24入)
ロット1
麻紐付・小箱入
4951169103872



660-033S ▽
φ18
¥1,380 (48入)
ロット1
麻紐付・小箱入
4951169103889



660-056 ▽
φ24
¥2,200 (24入)
ロット1
麻紐付・小箱入
4951169108303



660-056S ▽
φ18
¥1,380 (48入)
ロット1
麻紐付・小箱入
4951169108310



660-048 ▽
φ24
¥2,500 (24入)
ロット1
麻紐付・小箱入
4951169107207



660-048S ▽
φ18
¥1,480 (48入)
ロット1
麻紐付・小箱入
4951169107214



660-017 ▽
φ24
¥2,200 (24入)
ロット1
麻紐付・小箱入
4951169100338



660-017S ▽
φ18
¥1,380 (48入)
ロット1
麻紐付・小箱入
4951169100345



660-018 / 739-037W



660-057 ▽
 φ24
 ¥2,200 (24入)
 ロット1
 麻紐付・小箱入
 4951169108327



660-057S ▽
 φ18
 ¥1,380 (48入)
 ロット1
 麻紐付・小箱入
 4951169108334



660-049 ▽
 φ24
 ¥2,200 (24入)
 ロット1
 麻紐付・小箱入
 4951169107221



660-049S ▽
 φ18
 ¥1,380 (48入)
 ロット1
 麻紐付・小箱入
 4951169107238



660-018 ▽
 φ24
 ¥2,200 (24入)
 ロット1
 麻紐付・小箱入
 4951169100291



660-018S ▽
 φ18
 ¥1,380 (48入)
 ロット1
 麻紐付・小箱入
 4951169100307

ホームページ・webカタログ



www.basket.co.jp

2024 New Items Information



Stone Plastic Material Popular Lineup

ストーンプラスチックマテリアル 人気ラインナップ



White



150-030W



150-010W



150-019W



150-024W



150-006W



150-005W



Gray



150-030G



150-010G



150-019G



150-024G



150-006G



150-005G



Black



150-030K



150-010K



150-019K



150-024K



150-006K



150-005K



Taupe



150-030B



150-010B



150-019B



150-024B



150-006B



150-005B



Beige



150-030BE



150-011BE



150-019BE



150-024BE



150-006BE



150-005BE



Gold



150-019YG



150-024YG



150-006YG



150-005YG



Lime Green



150-030LG



150-011LG

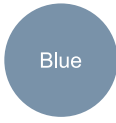

Blue



150-030BL



150-011BL



150-019BL

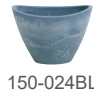

150-024BL



150-006BL



150-005BL



Pink



150-030P



150-011P



150-019P



150-024P



150-006P



150-005P



Purple



150-030V



150-011V



150-019V



150-024V



150-006V



150-005V



Red



150-011R

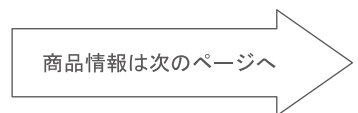

Stone Plastic Material Popular Lineup

White Stone



150-030W 
 φ 10×H10
 ¥400 (96入)
 ロット6 1/6本用
 4951169103582

Gray



150-030G 
 φ 10×H10
 ¥400 (96入)
 ロット6 1/6本用
 4951169103544

Black



150-030K 
 φ 10×H10
 ¥400 (96入)
 ロット6 1/6本用
 4951169103551

Taupe



150-030B 
 φ 10×H10
 ¥400 (96入)
 ロット6 1/6本用
 4951169103537

Beige



150-030BE 
 φ 10×H10
 ¥400 (96入)
 ロット6 1/6本用
 4951169105470

Lime Green



150-030LG 
 φ 10×H10
 ¥400 (96入)
 ロット6 1/6本用
 4951169103513

Blue



150-030BL 
 φ 10×H10
 ¥400 (96入)
 ロット6 1/6本用
 4951169103520

Pink



150-030P 
 φ 10×H10
 ¥400 (96入)
 ロット6 1/6本用
 4951169103568

Purple



150-030V 
 φ 10×H10
 ¥400 (96入)
 ロット6 1/6本用
 4951169103575

White Stone



150-010W 
 φ 12×H12
 ¥520 (48入)
 ロット1 1/3本用
 4951169020162

Gray



150-010G 
 φ 12×H12
 ¥520 (48入)
 ロット1 1/3本用
 4951169047893

Black



150-010K 
 φ 12×H12
 ¥520 (48入)
 ロット1 1/3本用
 4951169020148

Taupe



150-010B 
 φ 12×H12
 ¥520 (48入)
 ロット1 1/3本用
 4951169020124

Beige



150-011BE 
 φ 12×H12
 ¥520 (48入)
 ロット1 1/3本用
 4951169105449

Lime Green



150-011LG 
 φ 12×H12
 ¥520 (48入)
 ロット1 1/3本用
 4951169103476

Blue



150-011BL 
 φ 12×H12
 ¥520 (48入)
 ロット1 1/3本用
 4951169103483

Pink



150-011P 
 φ 12×H12
 ¥520 (48入)
 ロット1 1/3本用
 4951169020186

Purple



150-011V 
 φ 12×H12
 ¥520 (48入)
 ロット1 1/3本用
 4951169020216

Red



150-011R 
 φ 12×H12
 ¥520 (48入)
 ロット1 1/3本用
 4951169100246

Stone Plastic Material Popular Lineup

White Stone



150-019W 
 13×9×H8.5
 ¥390 (96入)
 ロット6 1/8本用
 4951169047978

Gray



150-019G 
 13×9×H8.5
 ¥390 (96入)
 ロット6 1/8本用
 4951169047947

Black



150-019K 
 13×9×H8.5
 ¥390 (96入)
 ロット6 1/8本用
 4951169047961

Taupe



150-019B 
 13×9×H8.5
 ¥390 (96入)
 ロット6 1/8本用
 4951169047930

Beige



150-019BE 
 13×9×H8.5
 ¥390 (96入)
 ロット6 1/8本用
 4951169105456

Gold



150-019YG 
 13×9×H8.5
 ¥390 (96入)
 ロット6 1/8本用
 4951169105654

Blue



150-019BL 
 13×9×H8.5
 ¥390 (96入)
 ロット6 1/8本用
 4951169103490

Pink



150-019P 
 13×9×H8.5
 ¥390 (96入)
 ロット6 1/8本用
 4951169062001

Purple



150-019V 
 13×9×H8.5
 ¥390 (96入)
 ロット6 1/8本用
 4951169062100

White Stone



150-024W 
 15×11×H10
 ¥520 (72入)
 ロット1
 1/3本用 リブ付
 4951169085437

Gray



150-024G 
 15×11×H10
 ¥520 (72入)
 ロット1
 1/3本用 リブ付
 4951169085390

Black



150-024K 
 15×11×H10
 ¥520 (72入)
 ロット1
 1/3本用 リブ付
 4951169085406

Taupe



150-024B 
 15×11×H10
 ¥520 (72入)
 ロット1
 1/3本用 リブ付
 4951169085291

Beige



150-024BE 
 15×11×H10
 ¥520 (72入)
 ロット1
 1/3本用 リブ付
 4951169105463

Gold



150-024YG 
 15×11×H10
 ¥520 (72入)
 ロット1
 1/3本用 リブ付
 4951169105661

Blue



150-024BL 
 15×11×H10
 ¥520 (72入)
 ロット1
 1/3本用 リブ付
 4951169103506

Pink



150-024P 
 15×11×H10
 ¥520 (72入)
 ロット1
 1/3本用 リブ付
 4951169085413

Purple



150-024V 
 15×11×H10
 ¥520 (72入)
 ロット1
 1/3本用 リブ付
 4951169085420



150-024は内側に
 リブが付いています。

Stone Plastic Material Popular Lineup

White Stone



150-006W 
20×15×H12
¥780 (36入)
ロット1 1/2本用
4951169019975

Gray



150-006G 
20×15×H12
¥780 (36入)
ロット1 1/2本用
4951169047817

Black



150-006K 
20×15×H12
¥780 (36入)
ロット1 1/2本用
4951169019944

Taupe



150-006B 
20×15×H12
¥780 (36入)
ロット1 1/2本用
4951169019937

Beige



150-006BE 
20×15×H12
¥780 (36入)
ロット1 1/2本用
4951169105432

Gold



150-006YG 
20×15×H12
¥780 (36入)
ロット1 1/2本用
4951169105647

Blue



150-006BL 
20×15×H12
¥780 (36入)
ロット1 1/2本用
4951169103469

Pink



150-006P 
20×15×H12
¥780 (36入)
ロット1 1/2本用
4951169061400

Purple



150-006V 
20×15×H12
¥780 (36入)
ロット1 1/2本用
4951169061417

White Stone



150-005W 
25×18×H15
¥1,150 (24入)
ロット1 3/4本用
4951169019852

Gray



150-005G 
25×18×H15
¥1,150 (24入)
ロット1 3/4本用
4951169047794

Black



150-005K 
25×18×H15
¥1,150 (24入)
ロット1 3/4本用
4951169019845

Taupe



150-005B 
25×18×H15
¥1,150 (24入)
ロット1 3/4本用
4951169019814

Beige



150-005BE 
25×18×H15
¥1,150 (24入)
ロット1 3/4本用
4951169106798

Gold



150-005YG 
25×18×H15
¥1,150 (24入)
ロット1 3/4本用
4951169105630

Blue



150-005BL 
25×18×H15
¥1,150 (24入)
ロット1 3/4本用
4951169105623

Pink



150-005P 
25×18×H15
¥1,150 (24入)
ロット1 3/4本用
4951169061103

Purple



150-005V 
25×18×H15
¥1,150 (24入)
ロット1 3/4本用
4951169061202